



CONTENTS

● Products Guide	
Products Line Up	2
Applications Guide	10
Inductors Selection by Thickness	17
Cross Reference	18
Part Numbering	22
<hr/>	
● EMI Suppression Filter	
Ferrite Chip Beads	27
Ferrite Chip Bead Array	54
Common Mode Chokes	56
<hr/>	
● Chip Coils / Inductors	
For General Use (Multilayer/Wire wound)	83
For High Frequency Use (Multilayer/Wire wound)	94
Hearing Aid (HAC) Inductors	113
<hr/>	
● Power Inductors / Chokes	
Multilayer Type Power Inductors	123
Sealed Type Power Inductors	127
Power Inductors	164
Assembly Type Power Inductors	173
<hr/>	
● Hi-Current Power Inductors	
Assembly Type High Current Power Inductors	181
Molding Type High Current Power Inductors	186
<hr/>	
● Wireless Power Charging	
Wireless Power Charging	254
<hr/>	
● Lan Transformer and Lan Transformer Modules	
Lan Transformer	258
Lan Transformer Modules	260
● PC Board Gasket	
PC Board Gasket	269
<hr/>	
● Soldering and Mounting	270
● Packaging	271

- Please visit our website: www.tai-tech.com.tw for the latest specification.
- Detailed Specifications are available upon request.
- Customized specifications are available , please contact TAI-TECH for the details.
- 最新規格可瀏覽網站：www.tai-tech.com.tw
- 詳細規格可在需求時提供
- 特殊規格可開發，詳情請洽西北臺慶



Products Line Up

■ EMI Suppression Filters

SMD Type	Model	P/N	Package Size (mm)	Impedance Range (ohm)	Rated Current (mA)	Page
Ferrite Chip Beads		FCM-K,H	0402	75 – 120	220 – 260	27
			0603	60 – 1000	100 – 220	28
			1005	30 – 1000	50 – 300	30
			1608	30 – 2000	150 – 700	32
			2012	11 – 2000	250 – 900	35
			3216	26 – 600	400 – 900	38
		FCM-C,M,B,N	0603	10 – 120	100 – 200	28
			1005	60 – 300	50 – 100	30
			1608	10 – 1000	80 – 700	32
			2012	7 – 1000	200 – 700	35
		FCM-W	0402	10 – 120	240 – 540	27
			0603	22 – 600	150 – 500	28
		GHB	1005	600 – 1800	200 – 300	40
High Current Ferrite Chip Beads		HCB	0603	10 – 120	850 – 1300	41
			1005	10 – 220	1500 – 3000	42
			1608	26 – 600	1000 – 6000	44
			2012	30 – 600	1000 – 3000	46
			3216	30 – 600	1000 – 3000	48
			4516	60 – 80	3000 – 6000	50
			4532	80 – 1300	3000 – 6000	51
Ultra High Current Ferrite Beads		BPH	323023	23	15000	53
			403025	22	10000	53
			853025	45	13000	53
Ferrite Chip Bead Array		FCA-K	3216	30 – 1000	150 – 500	54
		FCA-M	3216	30 – 300	200 – 400	
Common Mode Chokes		MCF	0605	12 – 90	100	56
			0806	12 – 90	100	57
			1210	40 – 90	100	58
		WCM-L2N	2012	67-180	300-400	59
		WCM-F2S	2012	67 – 1000	100 – 400	59
			3216	90 – 2200	200 – 400	62
			3225	90 – 1000	400 – 1000	64
			4532	90 – 800	1000 – 2000	65
		HDMI	2012	67 – 90	400	66
		HSF	1210	50 – 90	200 – 250	67
			2012	50 – 90	400	68
	LCM	4532	300-2000	200-300	69	
		TCM	252013	67	500	70
322512			160 – 500	200 – 500	71	

Products Line Up

■ EMI Suppression Filters

SMD Type	Model	P/N	Package Size (mm)	Impedance Range (ohm)	Rated Current (mA)	Page
Common Mode Chokes		ACM	3225	100 uH	150	72
			4532	11-200 uH	100-250	73
		DCM	3216	60 uH	200	74
			3532	75 uH	300	75
High Current Common Mode Chokes		SCM	7506	300-900	2000-5000	76
		WCM	5025	250-1500	1500-5000	77
			7060	40-1300	2500-15000	78
			9070	300-2700	2000-6000	79
			1211	700-1000	6000-8000	80
Balun Filters		BCM	2012	-	-	81

Products Line Up

■ Chip Coils / Inductors

Applications	Model	P/N	Package Size (mm)	Inductance Range (uH)	Rated Current (mA)	Page
For General Use		FCI	1005	0.220 – 2.20	10 – 25	83
			1608	0.047 – 10.0	15 – 50	84
			201209	0.047 – 2.2	30 – 300	85
			201212	0.470 – 10.0	15 – 200	
			3216	0.047 – 10.0	25 – 300	86
		SWF-LF	1608	0.047 – 10.0	270 – 1500	87
		SWF-C	1608	0.047 – 10.0	180 – 1400	89
			2012	0.470 – 33.0	145 – 750	90
			2520	1.000 – 33.0	236 – 1000	91
			3225	1.000 – 680	76 – 1200	92
	WIH	3225	10.0-220	60 – 200	93	
For High-Frequency Use		HCI	0603	0.8 – 100(nH)	60 – 500	94
			1005	1.0 – 330(nH)	50 – 400	97
			1608	1.5 – 180(nH)	150 – 400	100
		SWI-PF	0402	5.6 – 100(nH)	50 – 760	103
			0603	2.0 – 360(nH)	150 – 700	104
		SWI	0402	1.0 – 100(nH)	30 – 1360	105
			0603	2.0 – 390(nH)	100 – 700	107
			0805	2.8 – 1200(nH)	170 – 800	109
			1008	10.0 – 10000(nH)	150 – 1000	111
	Hearing Aid (HAC) Inductors		PAS	2016	1000	20
3010				280	50	114
3012				680	80	115
3015				1200	80	116
4018				1000	69	117
4420				2500 – 3500	20 – 40	118
6420				700 – 7500	10 – 80	119
8027				4500-19000	20	120
		1225	1300 – 13000	30 – 60	121	



Products Line Up

■ Power Inductors / Chokes

Description	Model	P/N	Package Size	Inductance Range (uH)	I _{rms} (A)	I _{sat} (A)	Page	
Multilayer Type Power Inductor		CPI	160808	0.24 – 2.20	0.75 – 1.20	-	123	
			201210	0.47 – 4.70	0.70 – 1.20	-	124	
			201610	0.47 – 4.70	0.90 – 1.60	-	125	
			252010	1.00 – 4.70	1.10 – 1.50	-	126	
Sealed Type Power Inductor		HPC	252008MF	0.47 – 10.0	0.41 – 1.25	0.50 – 2.20	127	
			3010TF	1.00 – 22.0	0.60 – 2.10	0.43 – 1.80	128	
			3012TF	1.00 – 22.0	0.61 – 2.00	0.49 – 2.15	129	
			3015TF	1.00 – 47.0	0.40 – 2.20	0.35 – 2.20	130	
			4010TF	1.00 – 22.0	0.50 – 1.90	0.45 – 2.00	131	
			4012TF	1.00 – 22.0	0.62 – 2.20	0.50 – 2.80	132	
			4018NF	1.00 – 22.0	0.30 – 3.70	0.30 – 4.00	133	
			5020NF	1.00 – 47.0	0.70 – 4.10	0.70 – 5.00	134	
			5040NF	1.00 – 100	0.72 – 5.00	0.75 – 7.50	136	
			6020NF	1.00 – 22.0	1.40 – 4.50	1.30 – 6.20	138	
			6045NF	0.36 – 470	0.40 – 9.00	0.50 – 18.0	140	
			8040NF	1.00 – 470	0.63 – 8.50	0.55 – 13.8	142	
		UHP	201610NF	0.47 – 22.0	0.27 – 2.35	0.38 – 2.70	143	
			252010BF	0.47 – 10.0	0.67 – 2.50	0.40 – 2.57	144	
			252012BF	0.47 – 22.0	0.45 – 3.35	0.50 – 3.60	145	
		DFP	201610TF	0.24 – 2.20	1.55 – 3.90	1.70 – 4.50	146	
			201612NF	0.24 – 2.20	1.30 – 3.50	1.60 – 4.80	147	
			252010NF	0.24 – 2.20	1.50 – 3.10	1.90 – 4.30	148	
	Sealed Type Ultra High Current Power Inductor		AHP	201610FA	0.24 – 4.70	1.80 – 5.70	1.60 – 7.50	150
				201610HF	0.24 – 4.70	1.20 – 5.90	1.10 – 7.00	152
252008RA				0.24 – 4.70	1.30 – 4.70	1.50 – 5.30	154	
252010FA				0.24 – 4.70	1.80 – 6.00	1.70 – 9.00	156	
252010HF				0.24 – 4.70	1.60 – 6.00	1.70 – 7.00	158	
252012RA				0.24 – 10.0	1.10 – 6.00	1.40 – 8.00	160	
252012HF				0.24 – 0.68	5.00 – 7.80	6.00 – 11.0	162	

Products Line Up

■ Power Inductors / Chokes



Description	Model	P/N	Package Size (mm)	Inductance Range (uH)	I _{rms} (A)	I _{sat} (A)	Page
Power Inductor		FPI	0302BM	1.00 – 120	IDC 0.14-1.50		164
			0403BM	1.00 – 120	IDC 0.20-4.00		166
			0503BM	1.50 – 33.0	IDC 1.40-4.10		168
			0504BM	1.00 – 120	IDC 0.60-3.50		169
			0703BM	10.0 – 330	IDC 0.28-1.44		171
			0705BM	3.30 – 470	IDC 0.34-4.60		172
Assembly Type Power Inductor		FWP	3216	0.47 – 22.0	0.16 – 0.70		173
		SDSL	10D30	0.80 – 150	0.51 – 8.30	0.84 – 11.2	174
	10D40		1.50 – 330	0.52 – 6.50	0.70 – 10.0	175	
	10D50		0.80 – 120	1.28 – 13.5	1.18 – 9.50	176	
		TPRHC	1204	3.90 – 330	0.50 – 6.50	-	177
		1205	1.30 – 1000	0.40 – 8.00	-	178	
1207		1.20 – 1000	0.55 – 9.80	-	179		

■ Hi-Current Power Inductors

Description	Model	P/N	Package Size	Inductance Range(uH)	I _{rms} (A)	I _{sat} (A)	Page
Assembly Type High Current Power Inductor		SLPI	070705-M32	0.072 – 0.150	24.0 – 31.0	30.0 – 58.0	181
			100705-M39	0.085 – 0.220	25.0 – 31.0	33.0 – 70.0	182
			131308-M53	0.210 – 0.440	30.0 – 45.0	35.0 – 71.0	183
			361108P4-M28	0.400	50.0	80.0	184
			451108P5-M28	0.400	50.0	80.0	185



Products Line Up

■ Hi-Current Power Inductors

Description	Model	P/N	Package Size	Inductance Range(uH)	I _{rms} (A)	I _{sat} (A)	Page
Molding Type High Current Power Inductor		AWP	201610AF	0.24 – 4.70	1.15 – 3.30	1.20 – 4.70	186
			252010AF	0.47 – 4.70	1.30 – 3.60	1.50 – 4.50	188
			252012AF	0.47 – 4.70	1.60 – 3.80	1.60 – 4.50	190
		AWP	201610BF	0.24 – 2.20	1.70 – 5.00	1.90 – 5.50	192
			252010IF	0.22 – 4.70	1.36 – 5.90	1.80 – 7.90	194
			252012IF	0.47 – 4.70	1.55 – 4.60	1.90 – 5.30	196
		TMPC	0312H	0.47 – 10.0	1.00 – 5.00	1.40 – 7.20	198
			0302H	0.10 – 10.0	1.40 – 10.5	1.60 – 14.0	199
			0412HP	0.10 – 10.0	1.30 – 11.5	1.40 – 25.0	200
			0402HP	0.33 – 22.0	1.20 – 10.0	1.40 – 18.0	201
			0512HP	0.10 – 10.0	1.50 – 14.0	1.80 – 14.5	202
			0515HP	0.20 – 22.0	1.20 – 15.0	1.70 – 22.5	203
			0518HP	0.33 – 15.0	1.70 – 11.0	2.30 – 15.0	204
			0612H	0.22 – 10.0	1.80 – 11.0	2.50 – 19.0	205
			0615H	0.22 – 22.0	1.50 – 14.0	2.50 – 22.0	206
			0618H	0.22 – 10.0	2.30 – 16.0	3.50 – 26.0	207
			0602H	0.10 – 22.0	1.50 – 21.0	2.50 – 40.0	208
			0624H	0.22 – 10.0	3.20 – 21.0	5.00 – 34.0	209
			0603H	0.10 – 10.0	3.50 – 32.5	6.00 – 60.0	210
			0604H	0.15 – 15.0	3.00 – 30.0	3.50 – 55.0	211
			0605H	0.33 – 22.0	2.90 – 25.0	5.50 – 32.0	212
			1004H	0.15 – 22.0	5.00 – 36.0	7.00 – 70.0	213
			1005H	0.30 – 68.0	2.50 – 38.0	4.00 – 65.0	214
			1235HP	0.10 – 10.0	7.00 – 43.0	14.0 – 84.0	215
	1205HP	0.20 – 22.0	6.50 – 52.0	10.0 – 110	216		
	1206HP	1.00 – 47.0	5.50 – 29.0	7.00 – 45.0	217		
	1265HP	0.15 – 47.0	6.50 – 55.0	9.50 – 118	218		
	1707HP	1.00 – 100	5.30 – 52.0	6.50 – 60.0	219		



Products Line Up

■ Hi-Current Power Inductors

Description	Model	P/N	Package Size	Inductance Range(uH)	I _{rms} (A)	I _{sat} (A)	Page
Molding Type High Current Power Inductor		TMPA	0503S	0.47 – 10.0	3.80 – 13.5	2.5 – 10.0	220
			0603S	0.15 – 22.0	2.50 – 30.0	3.00 – 40.0	223
			1004S	0.15 – 22.0	5.00 – 44.0	6.20 – 82.0	226
			2313SP	1.50 – 100	11.0 – 62.0	9.00 – 52.0	231
		TMPF	0402LR	0.47 – 4.70	5.10 – 13.2	4.00 – 14.0	234
			0402A	0.10 – 2.20	5.60 – 18.0	6.50 – 38.0	237
			0502A	0.15 – 1.50	8.80 – 18.8	13.3 – 30.0	240
			0503A	0.15 – 4.70	5.90 – 22.2	8.20 – 36.0	243
			0603A	0.18 – 4.50	7.00 – 32.0	8.00 – 36.0	246
			0605A	1.00 – 4.70	8.50 – 20.0	10.5 – 23.0	251
			0703A	0.60 – 8.20	5.90 – 23.0	10.2 – 36.0	253

Products Line Up

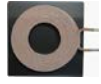
■ Wireless Power Charging

Description	Model	P/N	Package Size (mm)	Inductance Range (uH)	DCR (Ω)	Q Typ.	Page
Wireless Power Charging		PTX	505035	6.6	0.037	90	254
			505040	6.0	0.020	60	
			505050	6.6	0.037	90	
			505055	6.0 – 24.0	0.02–0.056	60 – 110	
		CTX	505028	6.3	0.037	90	255
			505040	6.0	0.018	80	
		PRX	383109	10.0	0.180	28	256
			423809	12.5	0.245	30	
			483209	10.5	0.236	28	

■ LAN Transformer

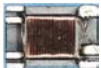
Description	Model	P/N	Package Size	Inductance Range(uH)			Page
LAN Transformer		TXF	4532	350-380			258
			5353	380			259

■ LAN Transformer Modules

Description	Model	P/N	Package Size	Type			Page
LAN Transformer Modules		LAN	12M162S	C			260
			16G241F/S	C			261
			12M162P	L			262
			16G241P/242P	L			264
			17G241P	L			266

■ PC Board Gasket

Description	Model	P/N	Package Size	Thickness			Page
PC Board Gasket		YPC	2015	0.90+0.07/-0.03			269

Applications Guide

■ Mobile Device

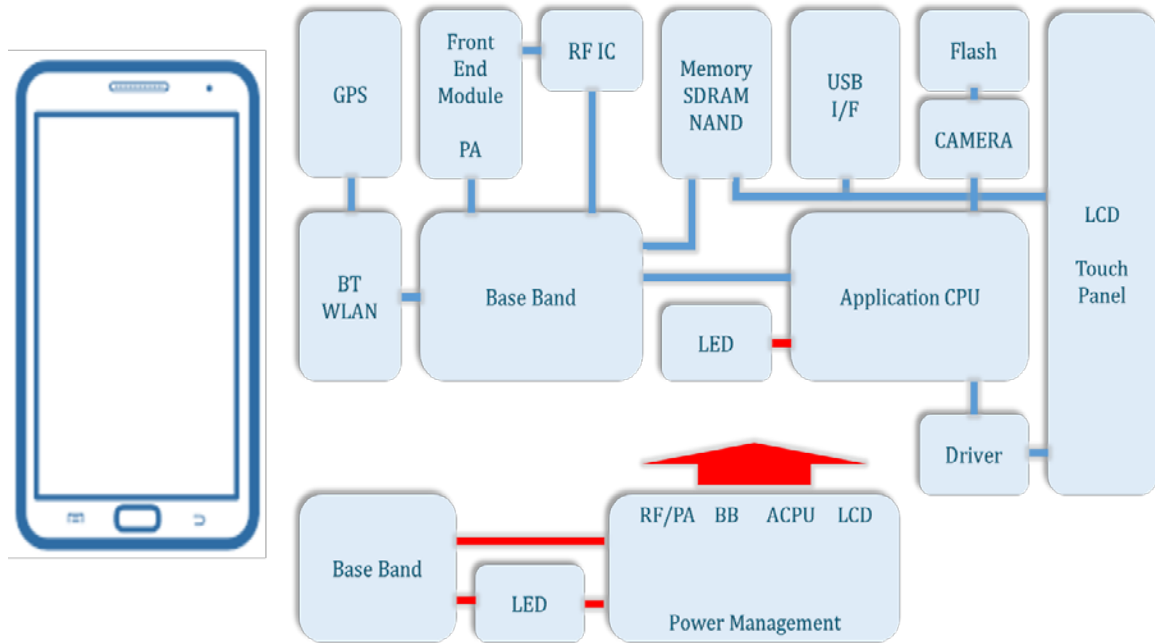

RF IC	Memory SDRAM NAND	USB I/F	BT WLAN	Base Band	LED	LCD Touch Panel	RF/PA BB ACPU LCD Power Management
HCI0603	HCB1005	FCM0603	HCI0603	FCM0603	AHP252008	MCF0605	AHP252008
HCI1005	HCB1608	GHB0603	HCI1005	GHB0603	AHP25201	MCG0806	AHP252010
SWI0402		FCM1005	FCM0603	FCM1005	AHP201610		AHP201610
SWI0603		HCB1005	GHB0603	HCB1005	DFP252010		DFP252010T
PAS4420		HCB1608	FCM1005	HCB1608	AWP201610		AWP201610
PAS201615		MCF0605	HCB1005	BCM2012	AWP252010		AWP252010
		MCG0806	HCB1608		CPI201610		CPI201610
			MCF0605		CPI252010		CPI252010
			MCG0806				

■ PC

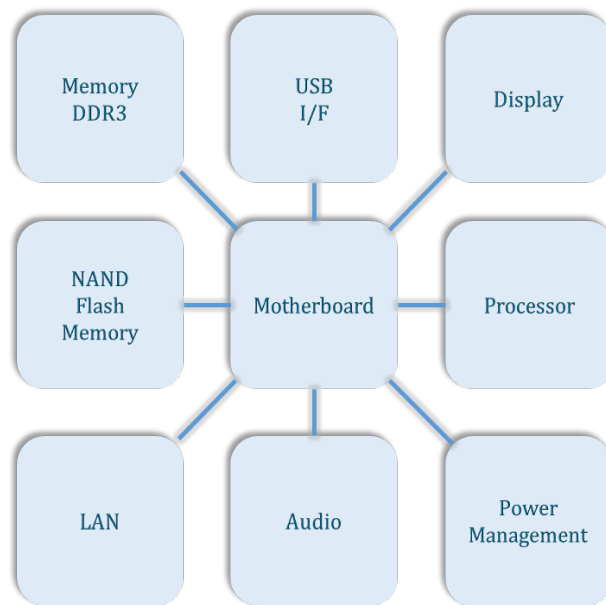

Memory DDR3	USB I/F	Display	LAN	Audio	Power Management
HCB1005	HCB1005	HPC3010	TXF4532	FCM0402	HPC3010
HCB0603	HCB0603	HPC3012	LPF2012	FCM0603	HPC3012
HCB1608	HCB1608	HPC3015	DCM3216	FCM1005	HPC3015
HCB2012	HCB2012	HPC5020	DCM3532		HPC5020
	HCB3216	AHP201610			AHP201610
	HCB4532	AHP252010			AHP252010
	MCF0806	AHP252012			AHP252012
	MCF1210				TMPC0412
	WCM2012				TMPC0402
	HSF2012				TMPC0618
	HSF1210				TMPC0624
					TMPA0503
					TMPA0603
					TMPA1004

■ NB

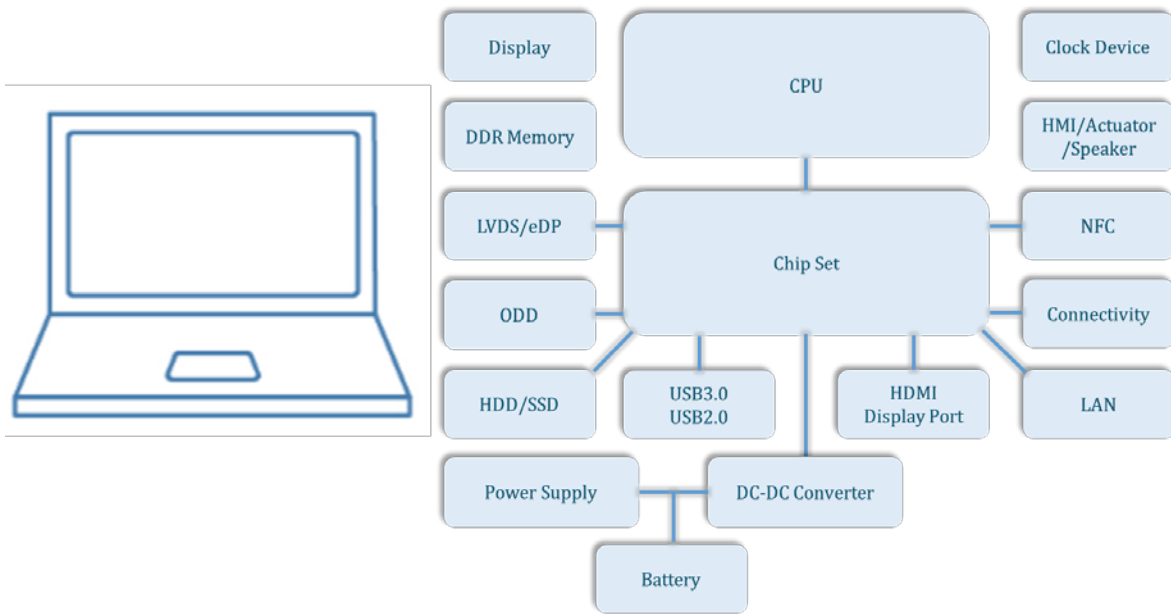

Display	DDR Memory	LVDS/eDP	HDD/SSD	USB2.0/3.0	HDMI
HPC3010	FCM0402	FCM0402 FCM0603	HPC3010	MCF0806	WCM2012
HPC3012	FCM0603	FCM1005	HPC3012	MCF1210	HSF2012
HPC3015	FCM1005	HCB1005 HCB0603	HPC3015	WCM2012	HSF1210
AHP201610	CPI1608	HCB1608 HCB2012	AHP201610	HSF2012	SWF1608
AHP252010	CPI2012	HCB3216 HCB4532	AHP252010	HSF1210	SWF2012
AHP252012		MCF0806 MCF1210 WCM2012 HSF1210 HSF2012	AHP252012		
HMI/Actuator /Speaker	LAN	DC-DC Converter		Power Supply	Battery
HPC3010	TXF4532	HPC3010 HPC3012 HPC3015		TMPC0412	TMPC0412
HPC3012	WCM2012	AHP201610 AHP252010 AHP252012		TMPC0402	TMPC0402
HPC3015	DCM3216	TMPC0412 TMPC0402		TMPC0618	TMPC0618
	DCM3532	TMPC0618 TMPC0624		TMPC0624	TMPC0624
		TMPA0503 TMPA0603		TMPA0503	TMPA0503
		TMPA1004		TMPA0603	TMPA0603
		CPI1608 CPI201210 CPI252010		TMPA1004	TMPA1004

Applications Guide

■ TV / Panel

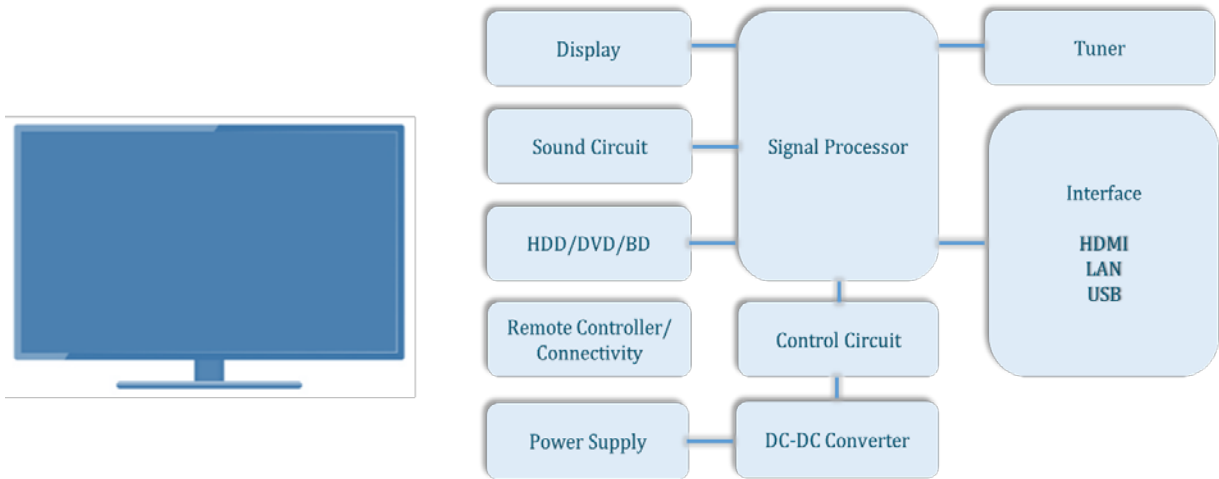

Display	HDD/DVD/BD	Remote Controller	Power Supply	DC-DC Converter	Tuner	Interface HDMI LAN USB
HPC5040	FCI1608	HCI1005	HPC5040	HPC5040	HCI1005	FCI1608
HPC6045	FCH1608	FCI1608	HPC6045	HPC6045	FCI1608	FCH1608
HPC8040	FCI2012	FCH1608	HPC8040	HPC8040	FCH1608	FCI2012
TMPC0603	HCB1005	FCI2012	TMPC0603	TMPC0603	FCI2012	LAN-12M162S7A8
TMPC1004	HCB1608	HCB1005	TMPC1004	TMPC1004	SWI0603	DCM3216
TMPC1206	HCB2012	HCB1608	TMPC1206	TMPC1206	FCM1005	WCM2012
TMPC1265	HCB1608	HCB2012	TMPC1265	TMPC1265	FCM1005	
DFP201610	HCB3216	HCB1608	DFP201610	DFP201610		
UHP252010	CPI201610PF	HCB3216	UHP252010	UHP252010		
HPC4010			HPC4010	HPC4010		
HPC4018			HPC4018	HPC4018		
HPC0502			HPC0502	HPC0502		
HPC0612			HPC0612	HPC0612		
HPC0620			HPC0620	HPC0620		
AWP201610			AWP201610	AWP201610		
AWP252010			AWP252010	AWP252010		
TMPC0418			TMPC0418	TMPC0418		
TMPC0612			TMPC0612	TMPC0612		
TMPC0624			TMPC0624	TMPC0624		
TMPC1206			TMPC1206	TMPC1206		
TMPC1265			TMPC1265	TMPC1265		

■ Net Device

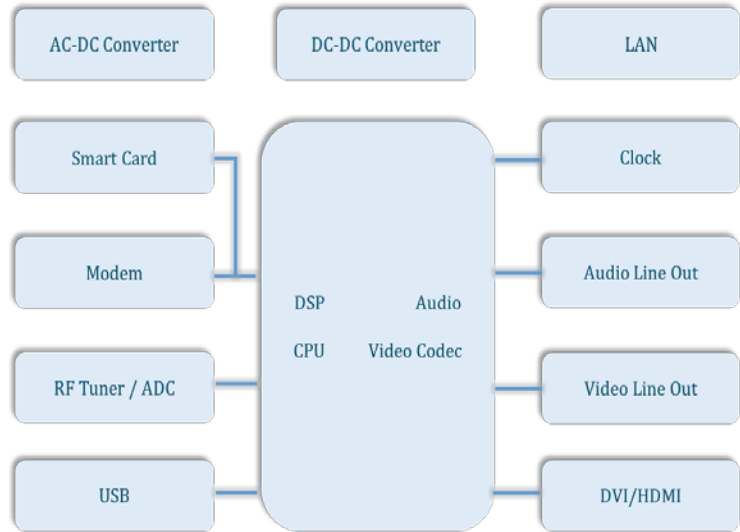

AC-DC Converter	RF Tuner / ADC	USB	DC-DC Converter	DSP CPU Codec	LAN	DVI/HDMI
UHP2520	HCI1005	WCM2012	UHP2520	SWI0402	LAN-12M162C7A8	WCM2012
HPC3010	HCI1608	HSF2012	HPC3010	SWI0603	LAN-16G241C1A8	HSF2012
HPC3012	SWI0402	HSF1210	HPC3012	SWI0805	TXF4532	HSF1210
HPC4018	SWI0603	WCM3216	HPC4018	SWI1008	DCM3216	WCM3216
HPC5020	SWI0805	WCM4532	HPC5020	HCB1608	DCM3532	WCM4532
HPC6045	SWI1008		HPC6045	HCB2012		
HPC8040	HCB1608		HPC8040	HCB3216		
TMPA0503	HCB2012		TMPA0503	FCM1005		
TMPA0603	HCB3216		TMPA0603	FCM1608		
TMPA1004			TMPA1004	FCM2012		
TMPA2313			TMPA2313			
TMPC1206			TMPC1206			
FPI32			FPI32			
FPI43			FPI43			
FPI54			FPI54			
FPI75			FPI75			
			CPI252010			

Applications Guide

■ Power

[DC/DC Converter]

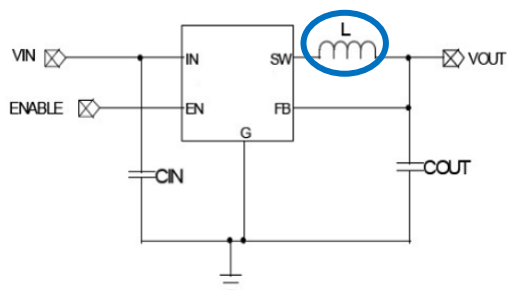

- AWP2016 AWP2520
- UHP2520 FP2520
- HPC3015 HPC4018
- HPC5040 HPC6045
- HPC8040
- TMPC0402 TMPC0603
- TMPC1004 TMPC1265
- TMPC1707 TMPC2313
- FPI0302 FPI0403
- FPI0504 FPI1005
- CPI2012 CPI2520

[Power Line Filter]

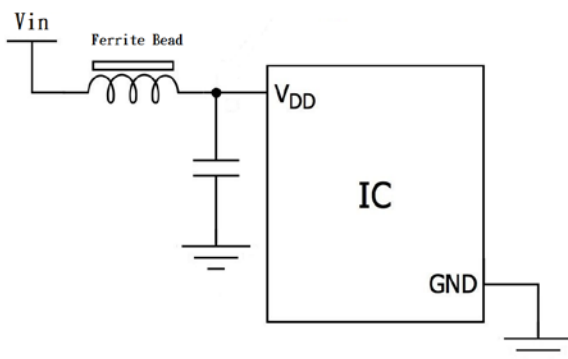

- HCB1608
- HCB2012
- HCB3216
- HCB4516
- HCB4532
- BPH3230
- BPH4030
- BPH8030

[Power Line Common mode choke]

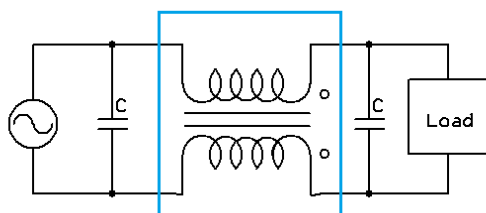

- WCM2012
- WCM3225
- WCM4532
- WCM5025
- SCM7506

■ Automotive

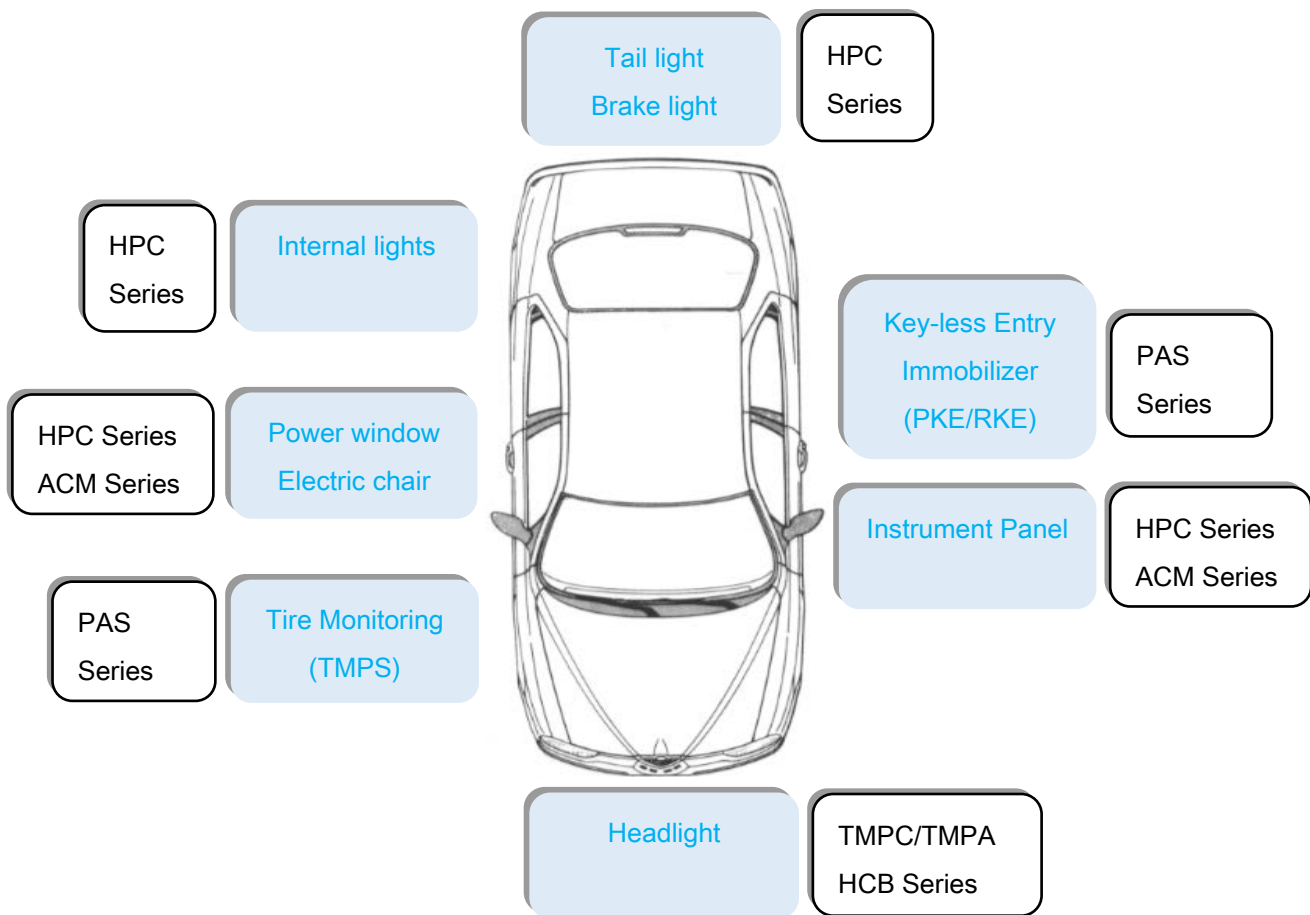

Inductors Selection by Thickness

Chip Coils / Inductors

Thickness (mm)	Ferrite (Multilayer)	Ferrite (Wire wound)	High Frequency (Multilayer)	High Frequency (Wire wound)
0.33	-	-	HCI 0603LF	-
0.60	FCI 1005F	-	HCI 1005LF	SWI 0402/SWI0402PF
1.00	FCI 1608F / FCI 2012F	SWF1608 LF	HCI 1608LF	-
1.20	-	SWF 1608CF	-	SWI 0603F/SWI0603PF
1.50	FCI 2012F / FCI 3216F	SWF 2012CF	-	SWI 0805UF
2.20	-	SWF 2520CF	-	SWI 1008UF
2.50	-	SWF 3225CF/WIH3225	-	-

Power Inductors / Chokes

Thickness (mm)	I _{rms} 1.0A max.	I _{rms} 3.0A max.	I _{rms} 5.0A max.	I _{rms} 7.0A max.	I _{rms} 10.0A max.
0.80	HPC252008/CPI160808	-	AHP252008	-	-
1.00	CPI160809/2012/2016 CPI2520 DHP252010/3010	HPI252010 HPC3010/4010/6010 UHP201610/252010	DFP201610/252010 AHP201610 AHP252010	-	-
1.20	DHP252012/3012	HPC2012/3012/4012 HPC5012/6012 FPC4012	UHP252012 DFP201612/252012	AHP252012	-
1.50	-	HPC3015	-	-	-
1.80	FWP321516	HPC4018	-	-	-
2.00	FPI0302	-	HPC5020/HPC6020	-	-
2.30	-	-	-	-	-
3.00	-	FPI0403/FPI0503	-	HPC8030	SDSL10D30
3.50	-	-	-	-	-
4.00	-	FPI0504	-	SDSL10D40	HPC8040
4.50	-	-	-	HPC6045	-
Up to 5.00	-	-	-	TPRHC1204	SDSL10D50 TPRHC1205/1207

Hi-Current Power Inductors

Thickness (mm)	I _{rms} 5.0A max.	I _{rms} 10.0A max.	I _{rms} 20.0A max.	I _{rms} 30.0A	I _{rms} 50.0A max.
1.00	AWP201610 AWP252010	-	-	-	-
1.20	AWP252012	TMPC0312	TMPC0412/0612	-	-
1.50	-	-	TMPC0515/0615	-	-
1.80	-	-	TMPC0518	TMPC0618	-
2.00	-	TMPC0302 TMPC0402	TMPC0402 TMPC0502	TMPC0502/0602	-
2.40	-	-	-	TMPC0624	-
3.00	-	TMPA0503	TMPF0603/0703	TMPC0503 TMPA0603 TMPC0603	TMPC0603
3.50	-	-	-	-	TMPC1235
4.00	-	-	-	-	TMPC0604/TMPC1004 TMPA1005
Up to 5.00	-	-	-	-	TMPC0605/1005/1205 TMPC1206/1265/1707 SLPI/TMPA2313

Cross Reference

Ferrite Chip Beads

TAI-TECH	muRata	TDK	TAIYO YUDEN	Page
FCM0402	BLM02	MMZ0402	BK0402	27
FCM0603	BLM03	MMZ0603	BK0603	28
FCM1005	BLM15	MMZ1005	BK1005	30
FCM1608	BLM18	MMZ1608	BK1608	32
FCM2012	BLM21	MMZ2012	BK2125	35
FCM3216	BLM31	-	-	38
GHB1005	BLM15HD	MMZ1005-E	BKH1005	40
HCB0603	BLM03KG	MPZ0603	BKP0603	41
HCB1005	BLM15KG/PX	MPZ1005	BKP1005	42
HCB1608	BLM18KG	MPZ1608	BKP1608	44
HCB2012	BLM21PG	MPZ2012	BKP2125	46
HCB3216	BLM31PG	-	FBMH3216	48
HCB4516	BLM41PG	-	FBMH4516	50
HCB4532	-	-	FBMH4532	51
FCA3216	BLA31	-	BK3216-4	54

Common Mode Chokes

TAI-TECH	muRata	TDK	TAIYO YUDEN	Page
MCF0605	DLP0Q	TCM0605	MCF0605	56
MCF0806	DLP0N	MCZ0806	MCF0806	57
MCF1210	DLP11	MCZ1210	MCF1210	58
WCM2012	DLW21H/S	ACM2012	-	59
WCM3216	DLW31	-	-	62
HDMI2012	DLW21	ACM2012H	-	66
HSF1210	-	-	CM01	67
HSF2012	DLW21	-	-	68
LCM4532	DLW43	ACT45B	-	69
TCM2520	-	ACM2520-3P	-	70
TCM3225	-	-	-	71
ACM3225	-	ACT1210L	-	72
ACM4532	-	ACT45L	-	73
BCM2012	DXW21	ATB2012	-	81

Chip Coils / Inductors

TAI-TECH	muRata	TDK	TAIYO YUDEN	CoilCraft	Page
FCI1005/1608/2012	LQM18N/21N	MLF1005/1608/2012	LK1005/1608/2125	-	83
SWF1608CF	-	-	-	0603LS	89
SWF2012CF	-	-	-	0805LS	90
SWF2520CF	-	-	-	1008LS	91
SWF3225CF	-	-	-	-	92
HCI0603LF	-	MLG0603	HK0603	-	94
HCI1005LF	LQG15	MLG1005	HK1005	-	97
HCI1608LF	LQP18	MLG1608	HK1608	-	100
SWI0402F	LQW15	-	-	0402CS	105
SWI0603F	LQW18	-	-	0603CS	107
SWI0805UF	LQW2B	-	-	0805CS	109
SWI1008UF	LQW2U	-	-	1008CS	111
PAS4420	-	-	-	-	118
PAS6420	LQW72HN	-	-	-	119
PAS1225	LQW1202	-	-	-	121

Cross Reference

Multilayer Type Power Inductors

TAI-TECH	muRata	TDK	TAIYO YUDEN	FDK	Page
CPI160808	LQM18P	MLP1608	CKP1608D	-	123
CPI201210	LQM21P	MLP2012	CKP2012	MIPSZ2012D	124
CPI201610	LQM2MP	MLP2016	CKP2016	MIPF2016D	125
CPI252010	LQM2HP	MLP2520	CKP2520	MIPSZ2520D	126

Sealed Type Power Inductors

TAI-TECH	TAIYO YUDEN	TDK	Panasonic	Cyntec	Page
HPC252008MF	-	VLS252008E	-	-	127
HPC3010TF	NRH3010	VLS3010E	ELLVEG	PST031T	128
HPC3012TF	NRH3012	VLS3012E	ELLVFG	PST031B	129
HPC3015TF	NRH3015	VLS3015E	ELLVGG	-	130
HPC4010TF	NRS4010	-	-	-	131
HPC4012TF	NRS4012	VLS4012	ELL4FG	PST041B	132
HPC4018NF	NRS4018	VLCF4018	ELL4LG	PST041H	133
HPC5020NF	NRS5020	VLCF5020	ELL5PR	-	134
HPC5040NF	NRS5040	-	-	PSI054T	136
HPC6020NF	NRS6020	SLF6020	-	-	138
HPC6045NF	NRS6045	VLP6045	-	PS064T	140
HPC8040NF	NRS8040	VLP8040	-	-	142
UHP201610CF	-	VLS201610	-	PSD20161T	143
UHP252010BF	-	VLS252010	-	PST25201T	144
UHP252012BF	-	VLS252012	ELLYFJ	PST25201B	145
DFP201610TF	MAKK2016	-	-	PIFE20161T	146
DFP201612NF	-	-	-	PIFE20161B	147
DFP252010NF	MAKK2520	-	-	PIFE25201T	148
DFP252012TF	MAMK2520	-	-	PIFE25201B	149

Ultra High Current Power Inductors

TAI-TECH	muRata	Taiyo	TDK	SUNLORD	Cyntec	Page
AHP201610FA		MEKK2016T	VLS2016HBX	WPN201610-R		150
AHP201610HF						152
AHP252008RA	DFE252008C				SEDT25200H	154
AHP252010FA			VLS252010HBX	WPN252010-HR		156
AHP252010HF			VLS252010HBX		SEDM25201T	158
AHP252012RA	1239-AS			WPN252012-H		160
AHP252012HF	DFE252012P					162

High Current Power Inductors

TAI-TECH	TAIYO YUDEN	TDK	INPAQ	Cyntec	Page
AWP201610AF	MAKK2016T	VLS2016HBX		PSE2016	186
AWP252010AF	MAKK2520T	VLS252010HBX		PSE2520	188
AWP252012AF	MAMK2520T	VLS252012HBX		PSE2520	190
AWP201610BF	MAKK2016T	VLS2016HBX	WIP2016P	PSE2016	192
AWP252010IF	MAKK2520T	VLS252010HBX	WIP2520P	PSE2520	194
AWP252012IF	MAMK2520T	VLS252012HBX	WIP2520P	PSE2520	196

Cross Reference

Assembly Type Power Inductors

TAI-TECH	SUMIDA	TDK	TOKO	Page
FWP3216	-	-	-	173
FPI0302	CD32			164
FPI0403	CD43			166
FPI0503				168
FPI0504	CD54			169
FPI0703	CD73			171
FPI0705	CD75			172
SDSL10D30F	CDRH103R	-	-	174
SDSL10D40F	CDRH104R	CLF10040	DS104LC	175
SDSL10D50F	CDRH105R	SLF10145	-	176
TPRHC1204F	CDRH124	-	D124C	177
TPRHC1205F	CDRH125	SLF12555	-	178
TPRHC1207F	CDRH127	SLF12565	D128C	179

High Current Power Inductors

TAI-TECH	VISHAY	TDK	TOKO	Cyntec	Page
SLPI070705	-	VLB7050	-	PCDA0707	181
SLPI100705	-	VLB10050	-	PCDA1007	182
SLPI131308	-	VLB12065	-	PCDF1313	183
SLPI361108	-	-	-	-	184
SLPI451108	-	-	-	-	185
TMPC0312H	IHLP-1212AB	SPM3012	FDSD0312	PIME031B	198
TMPC0302H	IHLP-1212BZ	-	-	-	199
TMPC0412HP	IHLP-1616AB	SPM4012	FDSD0412	PIMB041B	200
TMPC0402HP	IHLP-1616BZ	-	FDSD0420	PIMB042T	201
TMPC0512HP	IHLP-2020AB	SPM5012	FDSD0512	PIMB051B	202
TMPC0515HP	-	-	FDSD0515	PIME051E	203
TMPC0518HP	-	-	FDSD0518	PIMB051H	204
TMPC0612H	-	-	-	PIME061B	205
TMPC0615H	-	-	-	PIME061E	206
TMPC0618H	IHLP-2525AH	-	FDV0618	PIMB061H	207
TMPC0602H	-	-	FDV0620	-	208
TMPC0624H	IHLP-2525BD	-	-	PIMB062D	209
TMPC0603H	IHLP-2525CZ	SPM6530	FDV0630	PIMB063T	210
TMPC0604H	-	-	FDV0640	-	211
TMPC0605H	-	-	FDV0650	PIMB065T	212
TMPC1004H	IHLP-4040DZ	-	FDV1040	PIMB104T	213
TMPC1005H	-	-	-	PIMB104E	214
TMPC1235HP	IHLP-5050CE	-	-	PIMB133E	215
TMPC1205HP	IHLP-5050EZ	-	FDU1250	PIMB135T	216
TMPC1206HP	-	-	FDU1260	PIMB136T	217
TMPC1265HP	IHLP-5050FD	-	-	-	218
TMPC1707HP	IHLP-6767GZ	-	-	PIMB177T	219

Cross Reference

High Current Power Inductors

TAI-TECH	VISHAY	Coil Craft	TOKO	Cyntec	Page
TMPA0503S	IHLP2020CZ			PCMB503T	220
TMPA0603S	IHLP2525CZ			PCMB603T	223
TMPA1004S	IHLP4040DZ			PCMB104T	226
TMPA2313S	IHLP8787MZ				231
TMPF0402LR		XFL4020			234
TMPF0402A		XAL4020			237
TMPF0502A		XAL5020			240
TMPF0503A		XAL5030			243
TMPF0603A		XAL6030			246
TMPF0605A					251
TMPF0703A		XAL7030			253

LAN Transformer

TAI-TECH	TDK				Page
TXF453222	ACT4532M				258
TXF453229	ACT4532M				258
TXF535340					259

LAN Transformer Modules

TAI-TECH	BOTHHAND	PULSE			Page
LAN-12M162S					260
LAN-16G241F/S					261
LAN-12M162P	NS0013B				262
LAN-16G241P/242P	GST5009				264
LAN-17G241P		H5007NL			266

Part Numbering

■ Ferrite Chip Beads / Array

FCM **1608** **KF** - **121** **T** **06**

① ② ③ ④ ⑤ ⑥

① Series Name

Code	Series Name
FCM	Ferrite Chip Bead
GHB	GHz Ferrite Chip Bead
HCB/BPH	High Current Ferrite Chip Bead
FCA	Ferrite Chip Bead Array

② Dimension(AxB)

Code	Dimension(AxB)	EIA
0402	0.4mmX0.2mm	01005
0603	0.6mmX0.3mm	0201
1005	1.0mmX0.5mm	0402
1608	1.6mmx0.8mm	0603
2012	2.0mmx1.25mm	0805
3216	3.2mmx1.6mm	1206
4516	4.5mmx1.6mm	1806
4532	4.5mmx3.2mm	1812

③ Material Characteristics/Application

Code	Material Characteristics/Application	Series Name	
V	for General Use	FCM-V	
H		For GHz Band General	FCM-H
K		For Power Supplies	FCM-K, FCA-K
Z	for Low Speed	FCM-W	
W	Application		
M	for High Speed Signal Lines	FCM-M, FCA-M	
C, B		FCM-C, B	

④ Impedance

Code	Impedance(Ohm)
070	7Ω
700	70Ω
601	600Ω
202	2000Ω

⑤ Packaging

Code	Packaging
T	Plastic Taping(Φ180mm)
B	Bulk

⑥ Rated Current

Code	Rated Current(mA)
02	200
05	500
20	2000
60	6000

■ Common Mode Choke Coils / Balun

WCM **2012** **F** **2** **S** **F** - **900** **T**

① ② ③ ④ ⑤ ⑥ ⑦ ⑧ ⑨

① Series Name

Code	Common Mode Choke Coil
MCF	Multilayer Common Mode Filter
WCM	Winding Common Mode Filter for USB
HDMI	Winding Common Mode Filter for HDMI
HSF	Winding Common Mode Filter for USB
LCM	Winding Common Mode Filter
TCM	Tri-wired Common Mode Filter
ACM	Winding Common Mode Filter for Car
BCM	Balun Filter

② Dimension(AxB)

Code	Dimension(AxB)	EIA
0605	0.6mmx0.5mm	0202
0806	0.8mmx0.6mm	0302
1210	1.2mmx1.0mm	0504
2012	2.0mmx1.2mm	0805
3216	3.2mmx1.6mm	1206
3225	3.2mmx2.5mm	1210
4532	4.5mmx3.2mm	1812

③ Material Characteristics

Code	Material
F	Ferrite Material

④ Numbers of Signal Line

Code	Numbers of Signal Line
2	Two Lines
3	Three Lines
4	Four Lines

⑤ Type

Code	Type
S	Shielded Type
N	Non-Shielded Type

⑥ F: Lead Free

⑦ Impedance

Code	Impedance(Ohm)
900	90Ω
121	120Ω
102	1000Ω

⑧ Packaging T: Taping and Reel

⑨ Rated Current

Code	Rated Current(mA)
02	200
10	1000

Part Numbering

■ Chip Coils / Inductors

FCI **2012** **F** - **100** **M**

① ② ③ ④ ⑤

① Series Name

Code	
FCI	Ferrite Chip Inductor
SWF	Wirewound Ferrite Chip Inductor
WIH	Wirewound Ferrite Chip Inductor
HCI	High Frequency Chip Inductor
SWI	Wire Wound Ceramic Chip
PAS	Hearing Aid (HAC) Inductor

② Dimension(AxB)

Code	Dimension(AxB)	EIA
0603	0.6mmx0.3mm	0201
1005	1.0mmx0.5mm	0402
1608	1.6mmx0.8mm	0603
2012	2.0mmx1.2mm	0805
2520	2.5mmx2.0mm	1008
3216	3.2mmx1.6mm	1206
3225	3.2mmx2.5mm	1210
3010	3.0mmx3.0mmx1.0mm	1212
3012	3.0mmx3.0mmx1.2mm	1212
4420	4.4mmx2.0mm	1808
6420	6.4mmx2.0mm	2508

③ Material F: Lead Free

④ Inductance

Code	Inductance
1N0	1.0nH
10N	10nH
R10	100nH
1R0	1.0uH
100	10uH
101	100uH

⑤ Inductance Tolerance

Code	Inductance Tolerance
B	±0.1nH
C	±0.2nH
S	±0.3nH
G	±2%
H	±3%
J	±5%
K	±10%
L	±15%
M	±20%
Y	±30%

■ Power Inductors / Chokes

CPI **201210** **PF** - **1R0** **M** - **1A5**

① ② ③ ④ ⑤ ⑥

① Series Name

Code	
CPI	Multilayer Type Power Inductor
HPC	Sealed Type Power Inductor
UHP	
DFP	
AHP	
FWP	Assembly Type Power Inductor
SDSL	
TPRHC	

② Dimension(AxB)

Code	Dimension(AxB)	EIA
1608	1.6mmx0.8mm	0603
2012	2.0mmx1.25mm	0805
201610	2.0mmx1.6mm	0806
252010/12	2.5mmx2.0mm	1008
3010/12/15	3.0mmx3.0mm	1212
3216	3.2mmx1.6mm	1206
4010/12/18	4.0mmx4.0mm	1616
5020/40	5.0mmx5.0mm	2020
6020/45	6.0mmx6.0mm	2424
8040	8.0mmx8.0mm	3232
10D30/40/50	10mmx10mm	4040
1204/05/07	12mmx12mm	4848

③ Material

Code	Material
F	Ferrite Material for Wire wound Inductor
A	
B	
C	
CF	
NF	
TF	Ferrite Material For Multilayer Inductor
HF	
PF	
UF	

④ Inductance

Code	Inductance
R47	0.47uH
1R0	1.0uH
100	10uH
101	100uH

⑤ Inductance Tolerance

Code	Inductance Tolerance
K	±10%
M	±20%
Y	±30%

⑥ Rated Current

Code	Rated Current
0A6	0.60A
1A5	1.50A

Part Numbering

■ Hi-Current Power Inductors (Molding Type)

TMPC **0603** **H** - **4R7** **M** - **D**

① ② ③ ④ ⑤ ⑥

① Series Name

Code	
AWP	Molding Type Hi-Current Power
TMPC	
TMPA	Inductor
TMPF	

② Dimension(AxB)

Code	Dimension(AxB)	EIA
201610	2.0mmx1.6mm	0806
252010/12	2.5mmx2.0mm	1008
0310/02	3.0mmx3.0mm	1212
0412/02	4.0mmx4.0mm	1616
0512/15/18/02/03	5.0mmx5.0mm	2020
0612/18/24/03/05	6.0mmx6.0mm	2424
1004/05	10mmx10mm	4040
1235/05/06/65/07	12mmx12mm	4848
1707	17mmx17mm	6868

③ Material

Code	Material
F	Hi-Current Metal Material
H	
HP	

④ Inductance

Code	Inductance
R47	0.47uH
1R0	1.0uH
100	10uH
101	100uH

⑤ Inductance Tolerance

Code	Inductance Tolerance
M	±20%
Y	±30%

⑥ Control No.

■ Hi-Current Power Inductors (Assembly Type)

SLPI **070705** **MT** - **72N** **M** - **M32**

① ② ③ ④ ⑤ ⑥

① Series Name

Code	
SLPI	Assembly Type Hi-Current Power Inductor

② Dimension(AxB)

Code	Dimension(AxB)	EIA
070705	7.0mmx7.0mm	2828
100705	10mmx7.0mm	4028
131308	13mmx13mm	5252
361108(Array)	36mmx11mm	14444
451108(Array)	5.0mmx5.0mm	18044

③ Material

Code	Material
MT	Hi-Current Ferrite Material

④ Inductance

Code	Inductance
72N	72nH
R32	0.32uH
1R0	1.0uH

⑤ Inductance Tolerance

Code	Inductance Tolerance
M	±20%
Y	±30%

⑥ DC resistance

Code	DC Resistance
M28	0.28 ohm
M32	0.32 ohm

Part Numbering

■ Wireless Power Charging-Tx

PTX **505035** - **10** **W5M** **S** **N** - **30** - **00**

① ② ③ ④ ⑤ ⑥ ⑦ ⑧

① Series Name

Code	
PTX	Wireless Power Charging-Tx
CTX	Wireless Power Charging-Tx

② Dimension(AxBxC)

Code	Dimension(AxBxC)	Type
505028	50mmx50mmx2.8mm	CTX
505035	50mmx50mmx3.5mm	PTX
505040	50mmx50mmx4.0mm	PTX / CTX
505050	50mmx50mmx5.0mm	PTX
505055	50mmx50mmx5.5mm	PTX

③ Wire Turns

Code	Turns
10	10 turns
20	20 turns

④ Material

Code	Material
W5F	Ferrite Material
W5M	

⑤ Wire Type

Code	Description
S	Silk envelope
E	Enamelled wire

⑥ Magnet

Code	Description
M	Magnet
N	Non-Magnet

⑦ Serial No.

⑧ Version No.

■ Wireless Power Charging-Rx

PRX **433909** - **16** **KFA** - **NF**

① ② ③ ④ ⑤

① Series Name

Code	
PRX	Wireless Power Charging-Rx

② Dimension(AxBxC)

Code	Dimension(AxBxC)	Type
383109	38mmx31mmx0.9mm	PRX
483209	48mmx32mmx0.9mm	PRX
524807	52mmx48mmx0.7mm	PRX+NFC
433909	43mmx39mmx0.9mm	PRX+NFC

③ Wire Turns

Code	Turns
14	14 turns

④ Material

Code	Material
KFA	Ferrite Material

⑤ Control No.

Code	Description
01	Serial No.
NFC	NFC

■ LAN Transformer

TXF **453229** - **381** **NF** - **7P**

① ② ③ ④ ⑤

① Series Name

Code	
TXF	LAN Transformer

② Dimension(AxBxC)

Code	Dimension(AxBxC)	EIA
453222	4.5mmx3.2mmx2.2mm	1812
453229	4.5mmx3.2mmx2.9mm	1812
535340	5.3mmx5.3mmx4.0mm	2121

③ Inductance

Code	Inductance uH
381	380

④ Material

Code	Material
NF	Ferrite Material

⑤ Control No.

Code	Description
7P	7 Pins



EMI Suppression Filters

■ Ferrite Chip Beads	
FCM Series	27
■ GHz Ferrite Chip Beads	
GHB Series	40
■ High Current Ferrite Chip Beads	
HCB Series	41
■ Ultra High Current Ferrite Chip Beads	
BPH Series	53
■ Ferrite Chip Bead Arrays	
FCA Series	54
■ Multilayer Common Mode Chokes	
MCF Series	56
■ Wire wound Common Mode Chokes	
WCM L2N/F2S Series	59
HDMI Series	66
HSF Series	67
LCM Series	69
■ Tri-wires Common Mode Chokes	
TCM Series	70
■ Wire wound Common Mode Chokes	
ACM Series	72
DCM Series	74
■ High current Wire wound Common Mode Chokes	
SCM Series	76
WCM Series	77
■ Balun Filters	
BCM Series	81



■ Dimensions

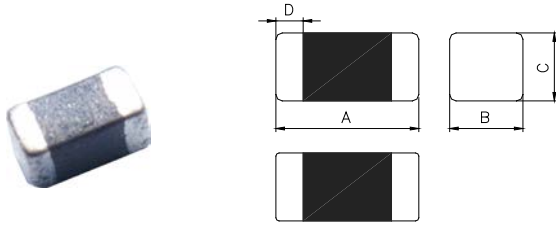

Chip Size	
A	0.40±0.02
B	0.20±0.02
C	0.20±0.02
D	0.10+0.04/-0.03

Units: mm

■ Specifications

Part Number	Impedance (Ω)	Test Frequency (MHz)	DC Resistance (Ω) max.	Rated Current (mA) max.
FCM0402WF-100T05	10±5 ohm	100	0.10	540
FCM0402WF-700T02	70±25%	100	0.37	280
FCM0402WF-121T02	120±25%	100	0.53	240
FCM0402HF-750T02	75±25%	100	0.45	260
FCM0402HF-121T02	120±25%	100	0.60	220

■ Impedance-Frequency Characteristics (Typical)

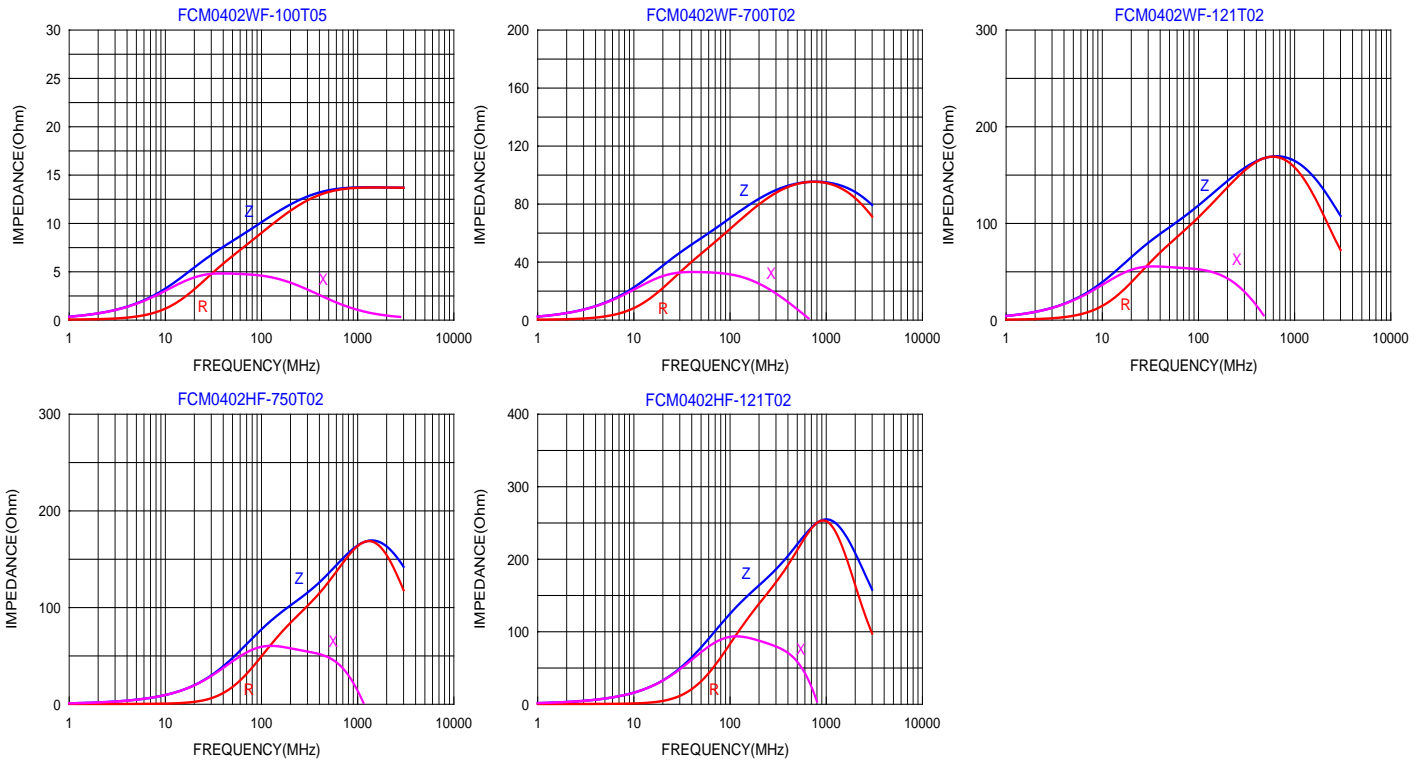

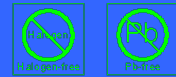

■ Dimensions

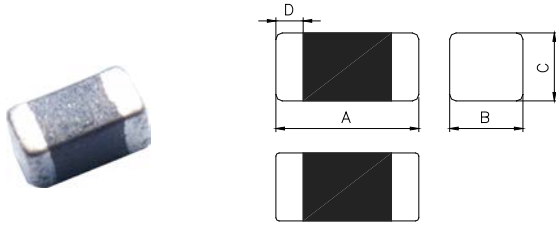

Dimensions	
A	0.60±0.03
B	0.30±0.03
C	0.30±0.03
D	0.15±0.05

Units: mm

■ Specifications

Part Number	Impedance (Ω)	Test Frequency (MHz)	DC Resistance (Ω) max.	Rated Current (mA) max.
FCM0603WF-220T05	22±25%	100	0.065	500
FCM0603WF-330T05	33±25%	100	0.07	500
FCM0603WF-800T02	80±25%	100	0.40	200
FCM0603WF-121T02	120±25%	100	0.45	200
FCM0603WF-241T02	240±25%	100	0.65	200
FCM0603WF-601T01	600±25%	100	1.20	150
FCM0603HF-600T02	60±25%	100	0.25	200
FCM0603HF-121T02	120±25%	100	0.40	200
FCM0603HF-241T02	240±25%	100	0.80	200
FCM0603HF-471T01	470±25%	100	1.05	100
FCM0603HF-601T01	600±25%	100	1.20	100
FCM0603KF-102T02	1000±25%	100	1.15	220
FCM0603BF-100T02	10±25%	100	0.25	200
FCM0603BF-220T02	22±25%	100	0.45	200
FCM0603BF-330T01	33±25%	100	0.55	150
FCM0603BF-470T01	47±25%	100	0.70	150
FCM0603BF-560T01	56±25%	100	1.00	100
FCM0603BF-800T01	80±25%	100	1.30	100
FCM0603BF-121T01	120±25%	100	1.50	100

■ Impedance-Frequency Characteristics (Typical)

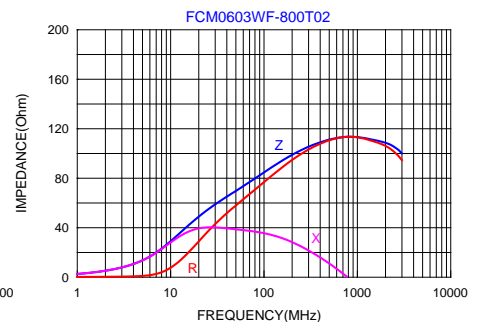
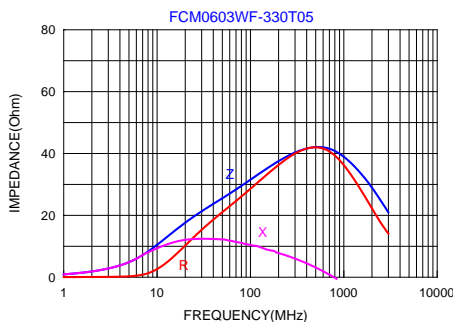
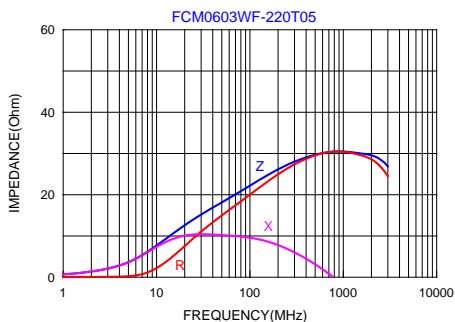



■ Impedance-Frequency Characteristics (Typical)

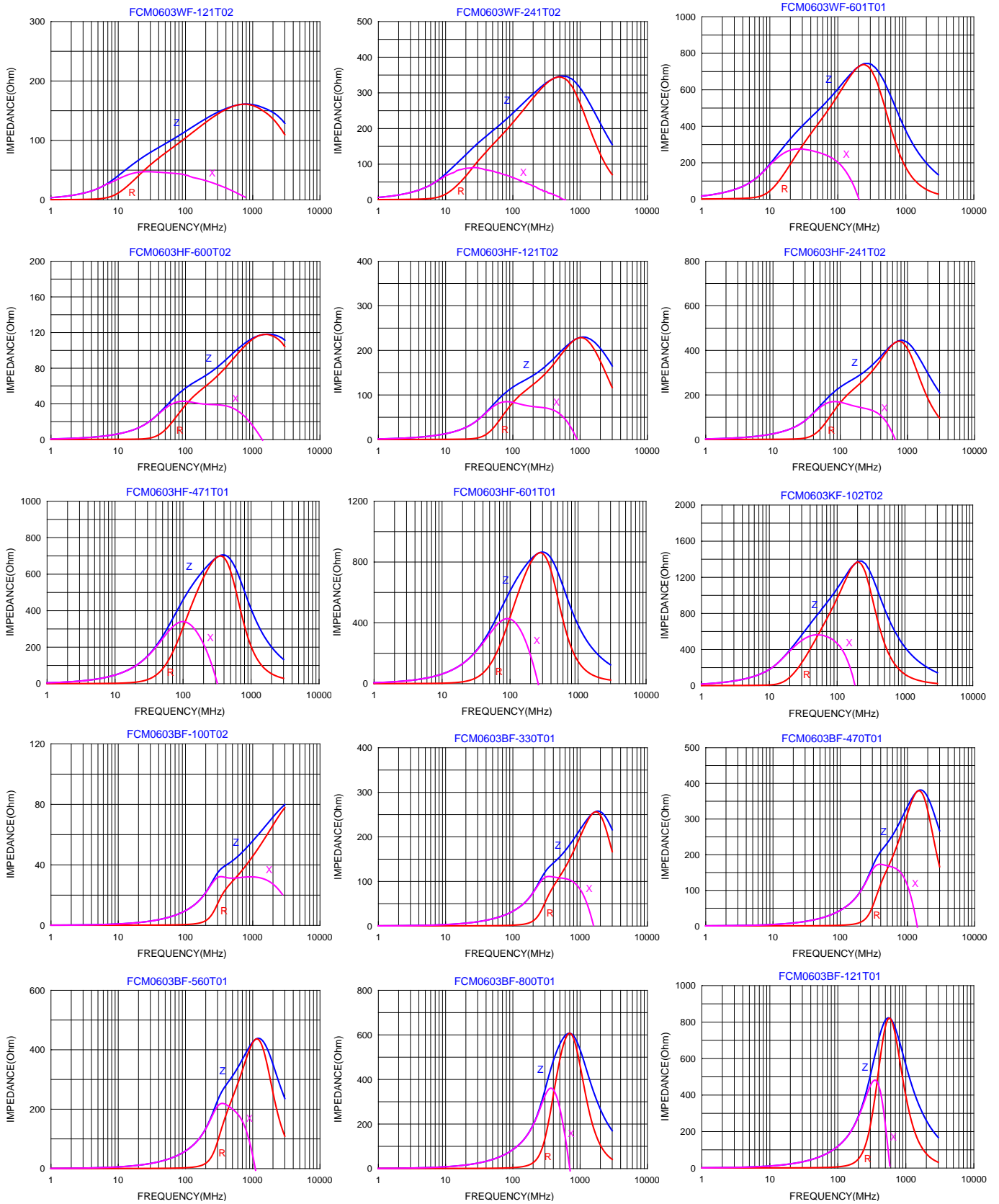



■ Dimensions

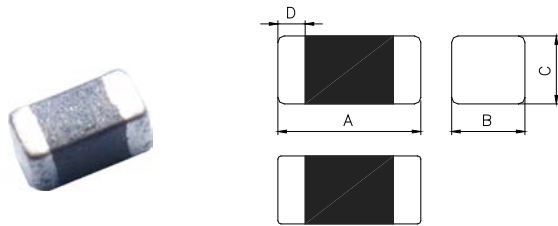

Chip Size	
A	1.00±0.10
B	0.50±0.10
C	0.50±0.10
D	0.25±0.10

Units: mm

■ Specifications

Part Number	Impedance (Ω)	Test Frequency (MHz)	DC Resistance (Ω) max.	Rated Current (mA) max.
FCM1005KF-300T03	30±25%	100	0.20	300
FCM1005KF-600T03	60±25%	100	0.25	300
FCM1005KF-121T01	120±25%	100	0.30	100
FCM1005KF-151T01	150±25%	100	0.30	100
FCM1005KF-221T01	220±25%	100	0.40	100
FCM1005KF-301T01	300±25%	100	0.50	100
FCM1005KF-471T01	470±25%	100	0.65	100
FCM1005KF-601T00	600±25%	100	0.80	80
FCM1005KF-102T00	1000±25%	100	1.20	50
FCM1005MF-600T01	60±25%	100	0.30	100
FCM1005MF-121T00	120±25%	100	0.45	80
FCM1005MF-221T00	220±25%	100	0.60	50
FCM1005MF-301T00	300±25%	100	0.75	50

■ Impedance-Frequency Characteristics (Typical)

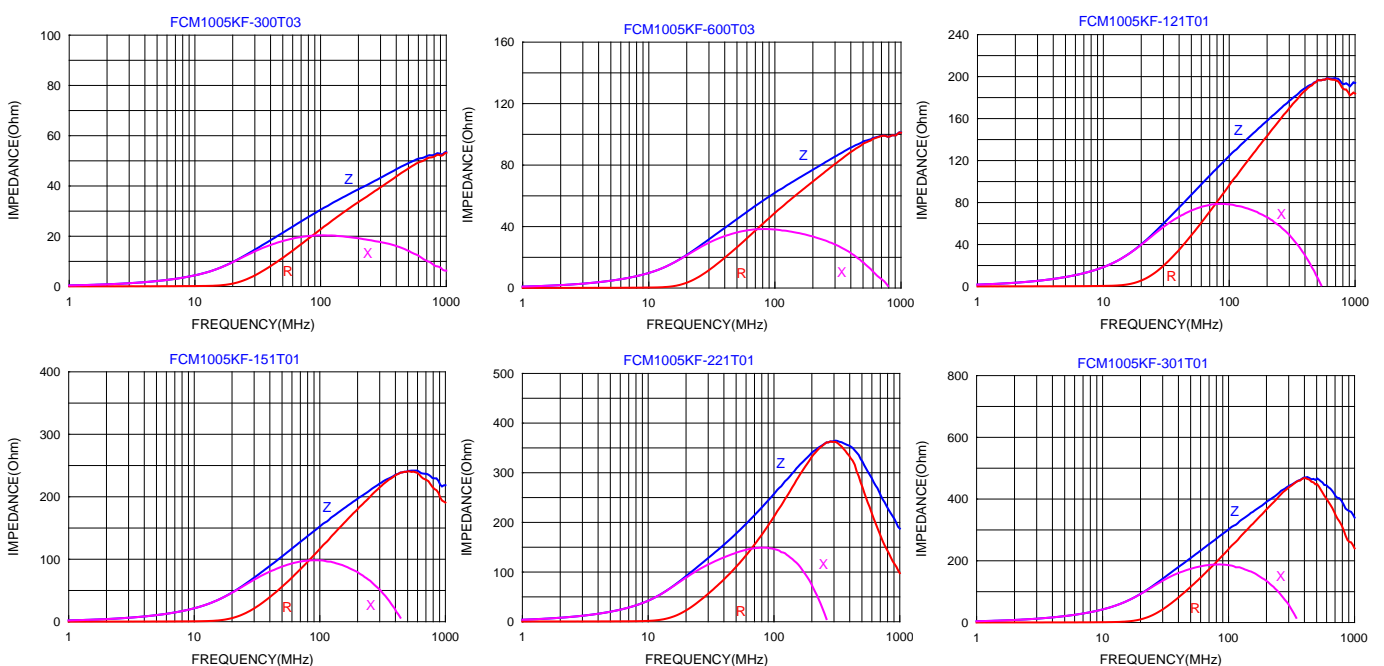



■ Impedance-Frequency Characteristics (Typical)

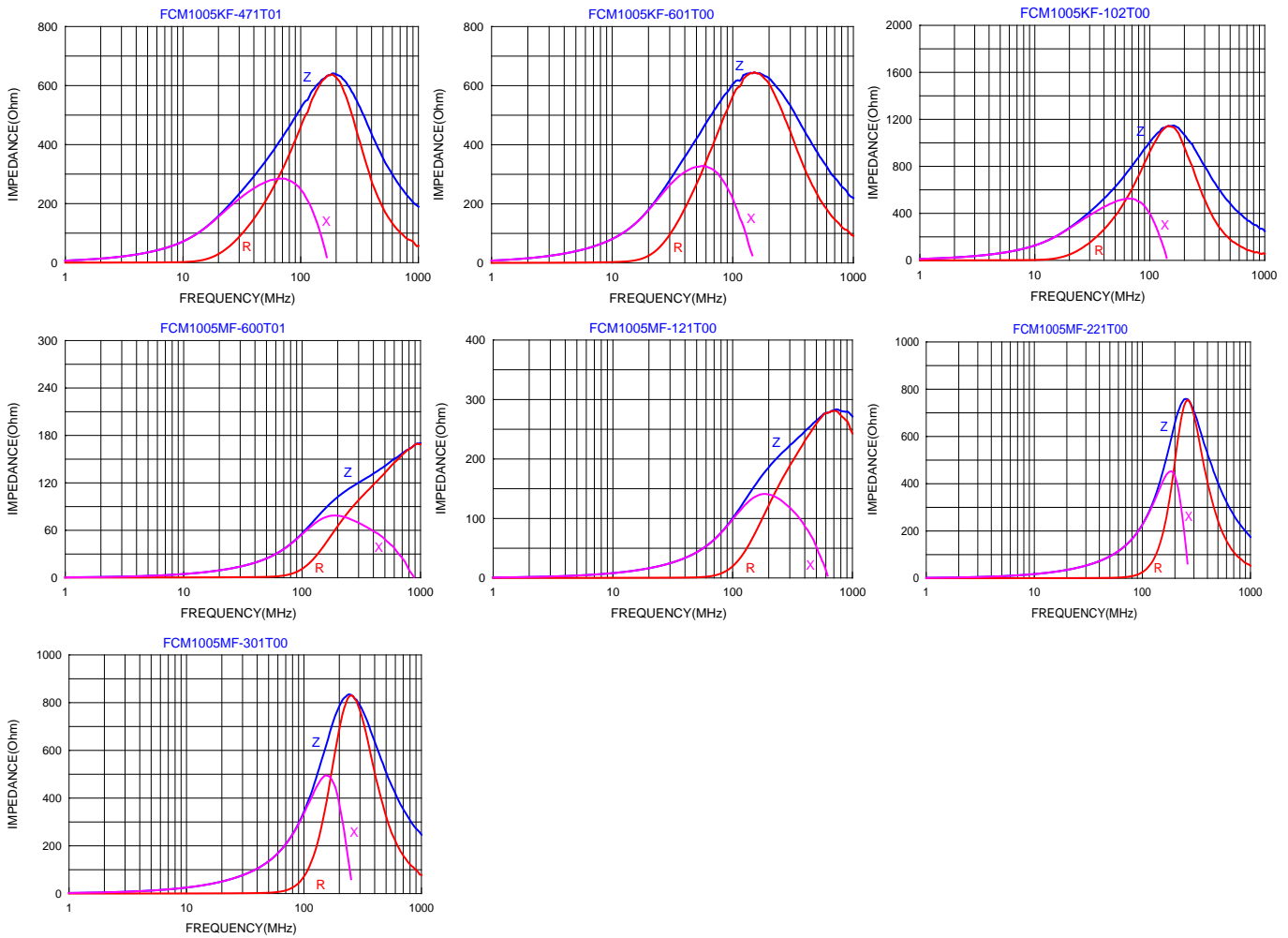



■ Dimensions

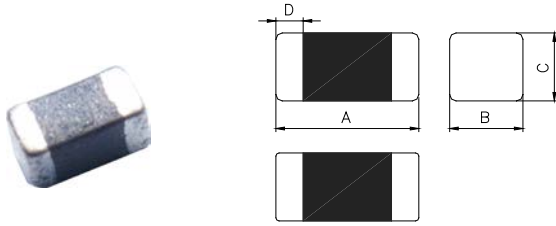

Chip Size	
A	1.60±0.15
B	0.80±0.15
C	0.80±0.15
D	0.30±0.20

Units: mm

■ Specifications

Part Number	Impedance (Ω)	Test Frequency (MHz)	DC Resistance (Ω) max.	Rated Current (mA) max.
FCM1608KF-300T07	30±25%	100	0.20	700
FCM1608KF-600T07	60±25%	100	0.20	700
FCM1608KF-121T06	120±25%	100	0.25	600
FCM1608KF-151T06	150±25%	100	0.25	600
FCM1608KF-221T05	220±25%	100	0.30	550
FCM1608KF-301T05	300±25%	100	0.35	500
FCM1608KF-471T03	470±25%	100	0.45	350
FCM1608KF-601T03	600±25%	100	0.50	350
FCM1608KF-102T02	1000±25%	100	0.70	200
FCM1608HF-152T02	1500±25%	100	1.00	200
FCM1608HF-202T01	2000±25%	100	1.20	150
FCM1608CF-100T07	10±25%	100	0.20	700
FCM1608CF-300T06	30±25%	100	0.25	600
FCM1608CF-600T06	60±25%	100	0.30	600
FCM1608CF-121T03	120±25%	100	0.40	300
FCM1608CF-151T03	150±25%	100	0.40	300
FCM1608CF-221T02	220±25%	100	0.60	250
FCM1608CF-301T02	300±25%	100	0.80	200
FCM1608CF-471T02	470±25%	100	0.85	200
FCM1608CF-601T01	600±25%	100	1.20	150
FCM1608CF-102T00	1000±25%	100	1.50	80

■ Impedance-Frequency Characteristics (Typical)

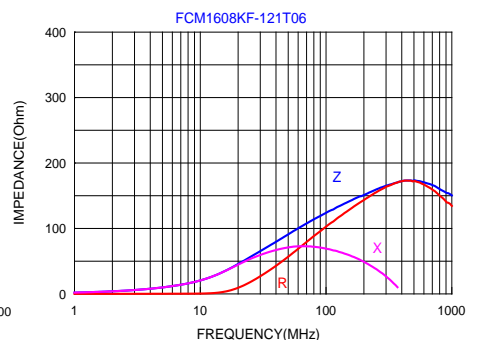
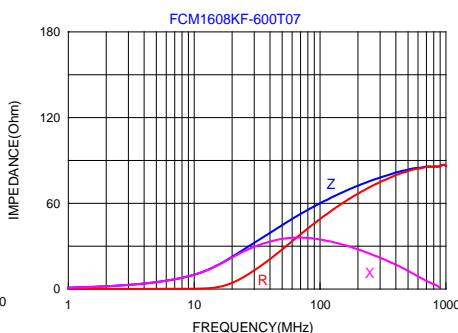
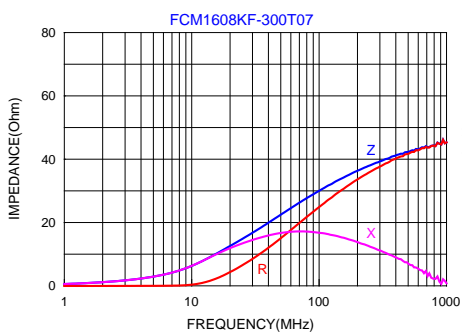



■ Impedance-Frequency Characteristics (Typical)

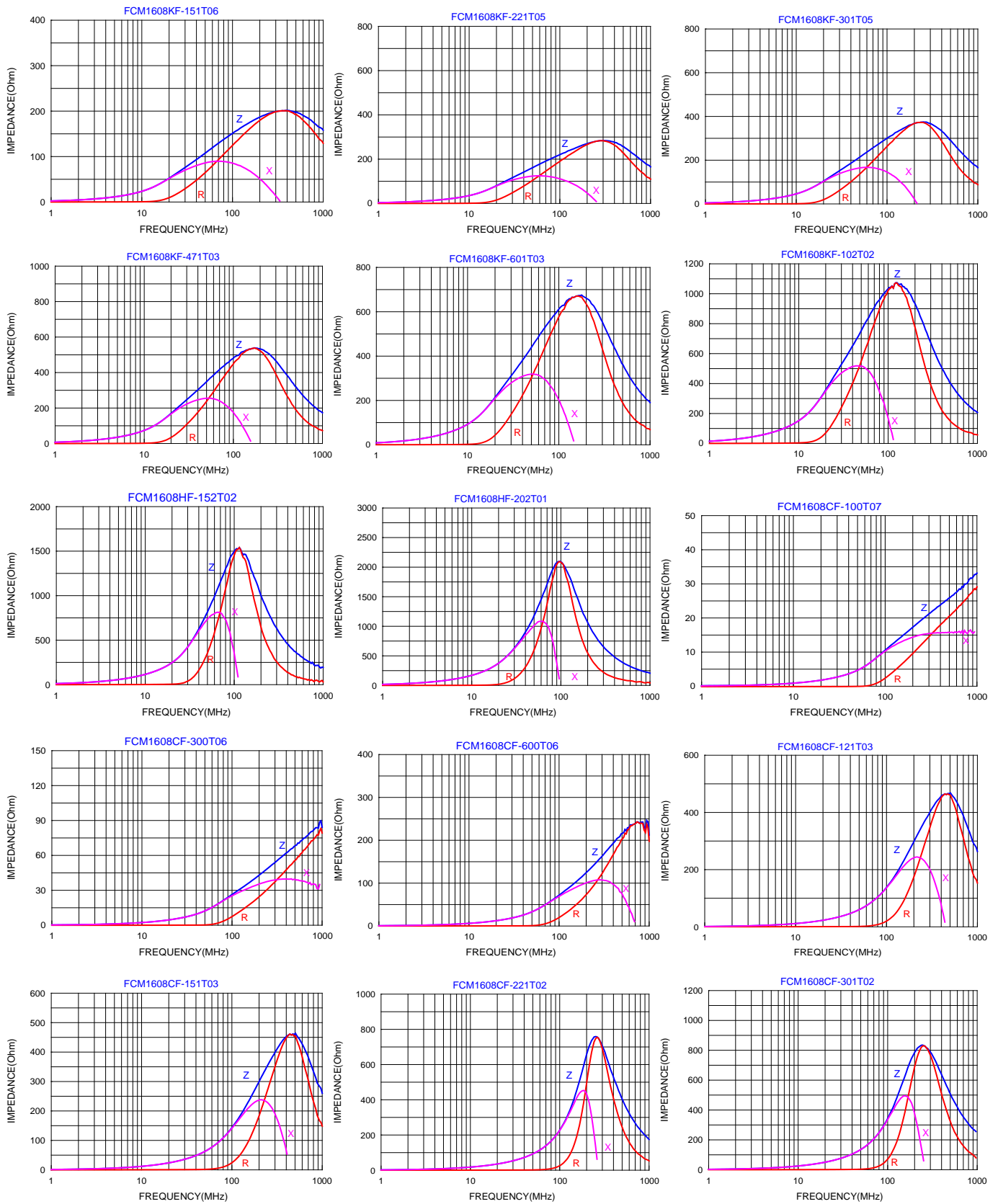



■ Impedance-Frequency Characteristics (Typical)

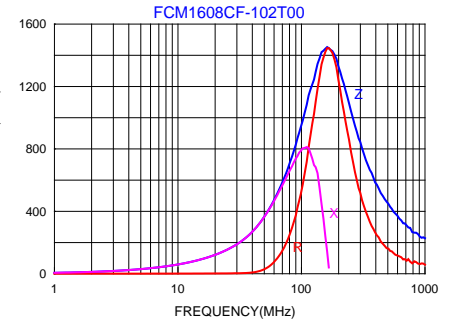
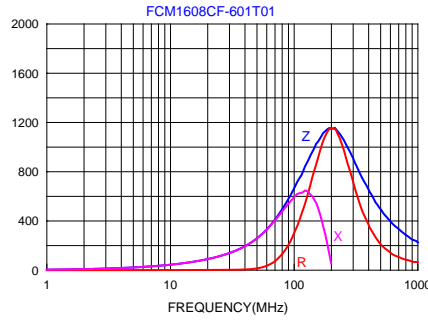
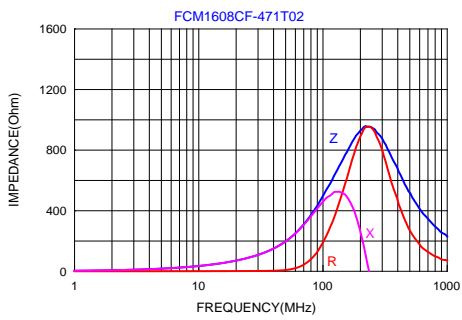

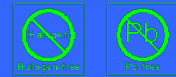

■ Dimensions

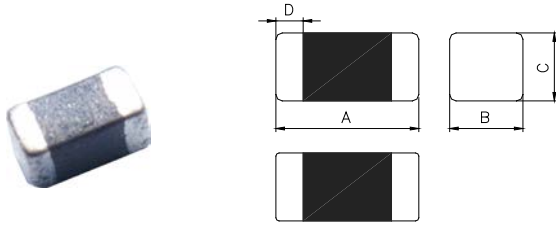

Chip Size	
A	2.00±0.20
B	1.25±0.20
C	0.85±0.20 1.25±0.20
D	0.50±0.30

Units: mm

■ Specifications

Part Number	Thickness C size (mm)	Impedance (Ω)	Test Frequency (MHz)	DC Resistance (Ω) max.	Rated Current (mA) max.
FCM2012KF-110T09	0.85±0.2	11±25%	100	0.10	900
FCM2012KF-170T06	0.85±0.2	17±25%	100	0.10	600
FCM2012KF-260T06	0.85±0.2	26±25%	100	0.10	600
FCM2012KF-300T06	0.85±0.2	30±25%	100	0.10	600
FCM2012KF-400T06	0.85±0.2	40±25%	100	0.10	600
FCM2012KF-600T09	0.85±0.2	60±25%	100	0.10	900
FCM2012KF-121T08	0.85±0.2	120±25%	100	0.20	800
FCM2012KF-151T08	0.85±0.2	150±25%	100	0.20	800
FCM2012KF-221T07	0.85±0.2	220±25%	100	0.30	750
FCM2012KF-301T07	0.85±0.2	300±25%	100	0.30	700
FCM2012KF-471T07	0.85±0.2	470±25%	100	0.35	700
FCM2012KF-601T05	0.85±0.2	600±25%	100	0.40	500
FCM2012KF-102T04	0.85±0.2	1000±25%	100	0.45	400
FCM2012HF-102T04	0.85±0.2	1000±25%	100	0.45	400
FCM2012HF-152T03	0.85±0.2	1500±25%	100	0.50	350
FCM2012HF-202T02	0.85±0.2	2000±25%	100	0.60	250
FCM2012NF-070T06	0.85±0.2	7±25%	100	0.10	600
FCM2012CF-300T07	0.85±0.2	30±25%	100	0.20	700
FCM2012CF-600T07	0.85±0.2	60±25%	100	0.20	700
FCM2012CF-121T06	0.85±0.2	120±25%	100	0.25	600
FCM2012CF-151T06	0.85±0.2	150±25%	100	0.25	600
FCM2012CF-221T04	0.85±0.2	220±25%	100	0.30	400
FCM2012CF-301T04	0.85±0.2	300±25%	100	0.35	400
FCM2012CF-471T04	1.25±0.2	470±25%	100	0.40	400
FCM2012CF-601T03	1.25±0.2	600±25%	100	0.45	300
FCM2012CF-102T02	1.25±0.2	1000±25%	100	0.50	200

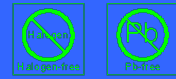

■ Impedance-Frequency Characteristics (Typical)

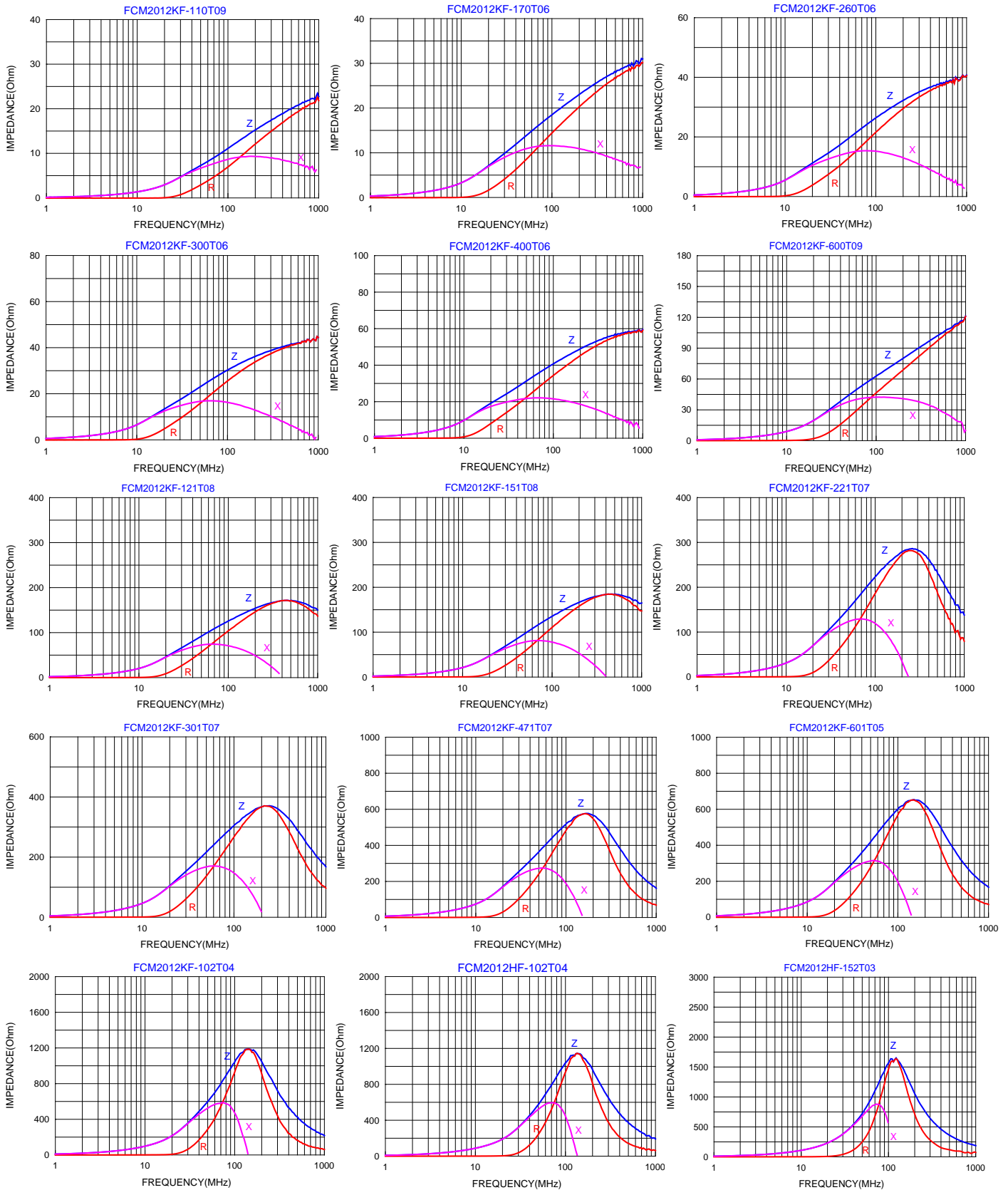

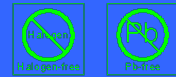

■ Impedance-Frequency Characteristics (Typical)

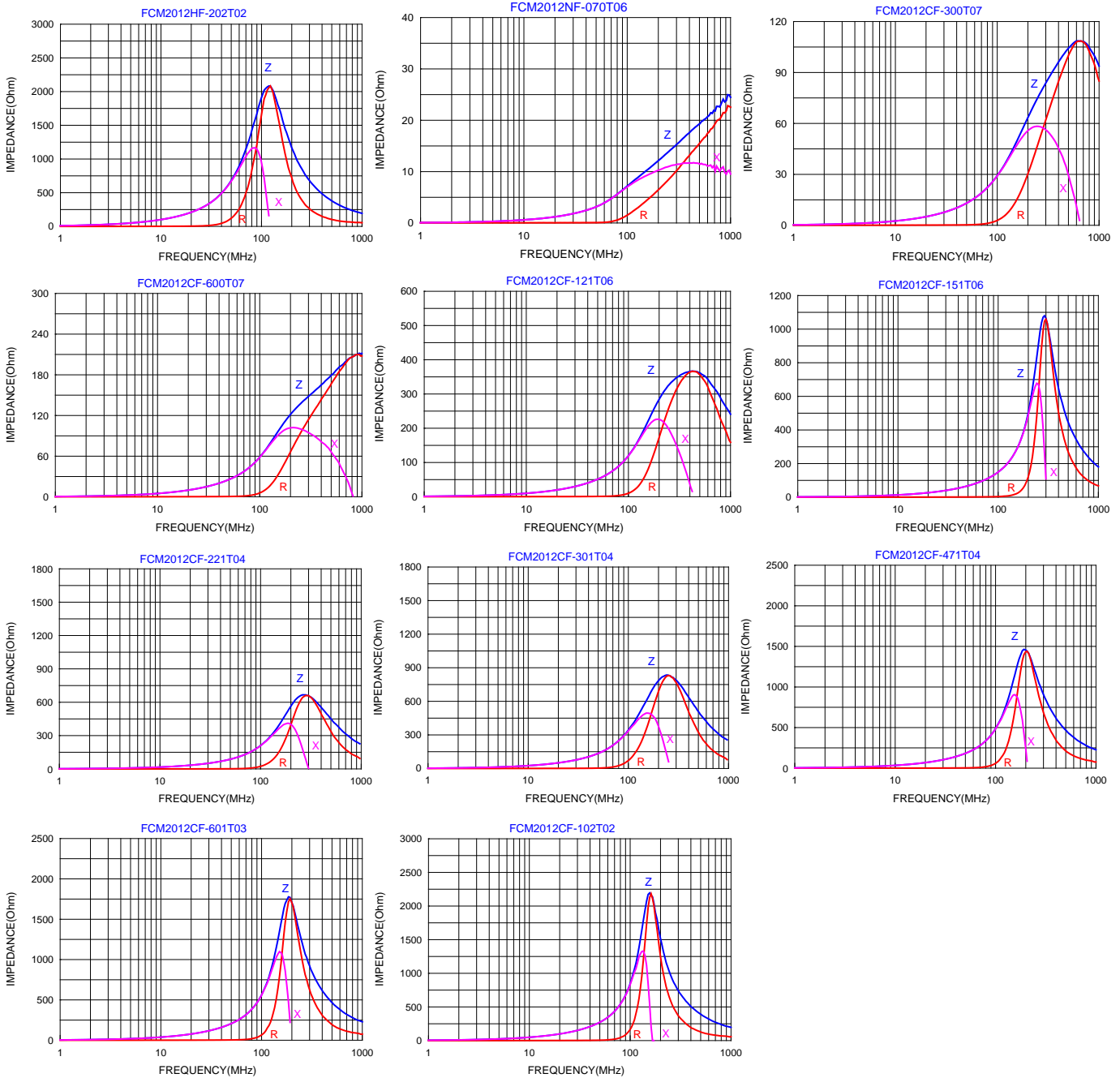



■ Dimensions

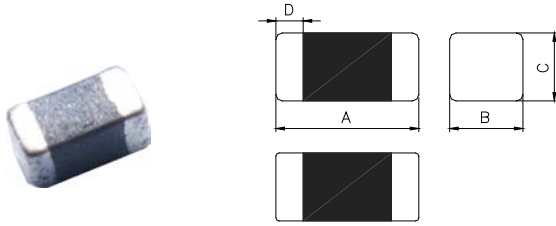

Chip Size	
A	3.20±0.20
B	1.60±0.20
C	1.10±0.20
D	0.50±0.30

Units: mm

■ Specifications

Part Number	Impedance (Ω)	Test Frequency (MHz)	DC Resistance (Ω) max.	Rated Current (mA) max.
FCM3216KF-260T05	26±25%	100	0.20	500
FCM3216KF-310T05	31±25%	100	0.20	500
FCM3216KF-420T05	42±25%	100	0.20	500
FCM3216KF-500T05	50±25%	100	0.20	500
FCM3216KF-700T05	70±25%	100	0.20	500
FCM3216KF-900T05	90±25%	100	0.20	500
FCM3216KF-121T09	120±25%	100	0.15	900
FCM3216KF-151T09	150±25%	100	0.15	900
FCM3216KF-201T06	200±25%	100	0.35	600
FCM3216KF-221T07	220±25%	100	0.35	700
FCM3216KF-301T07	300±25%	100	0.35	700
FCM3216KF-471T04	470±25%	100	0.35	400
FCM3216KF-601T04	600±25%	100	0.40	400

■ Impedance-Frequency Characteristics (Typical)

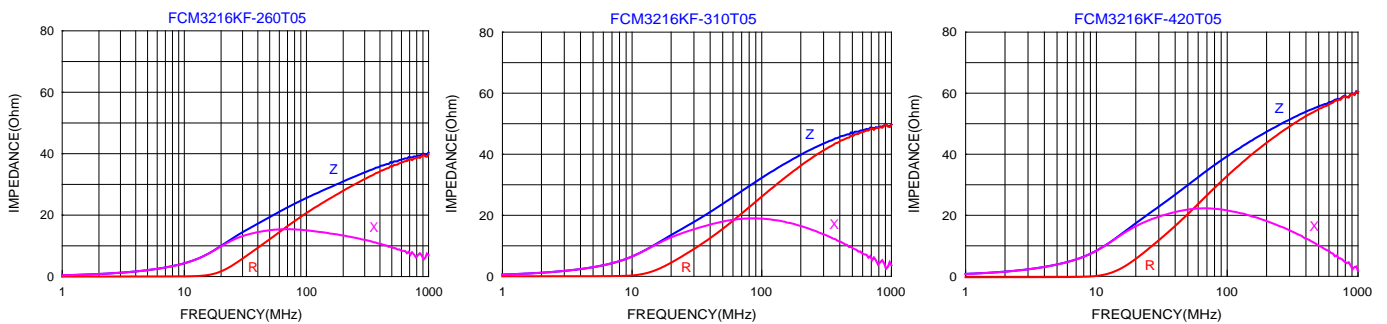



■ Impedance-Frequency Characteristics (Typical)

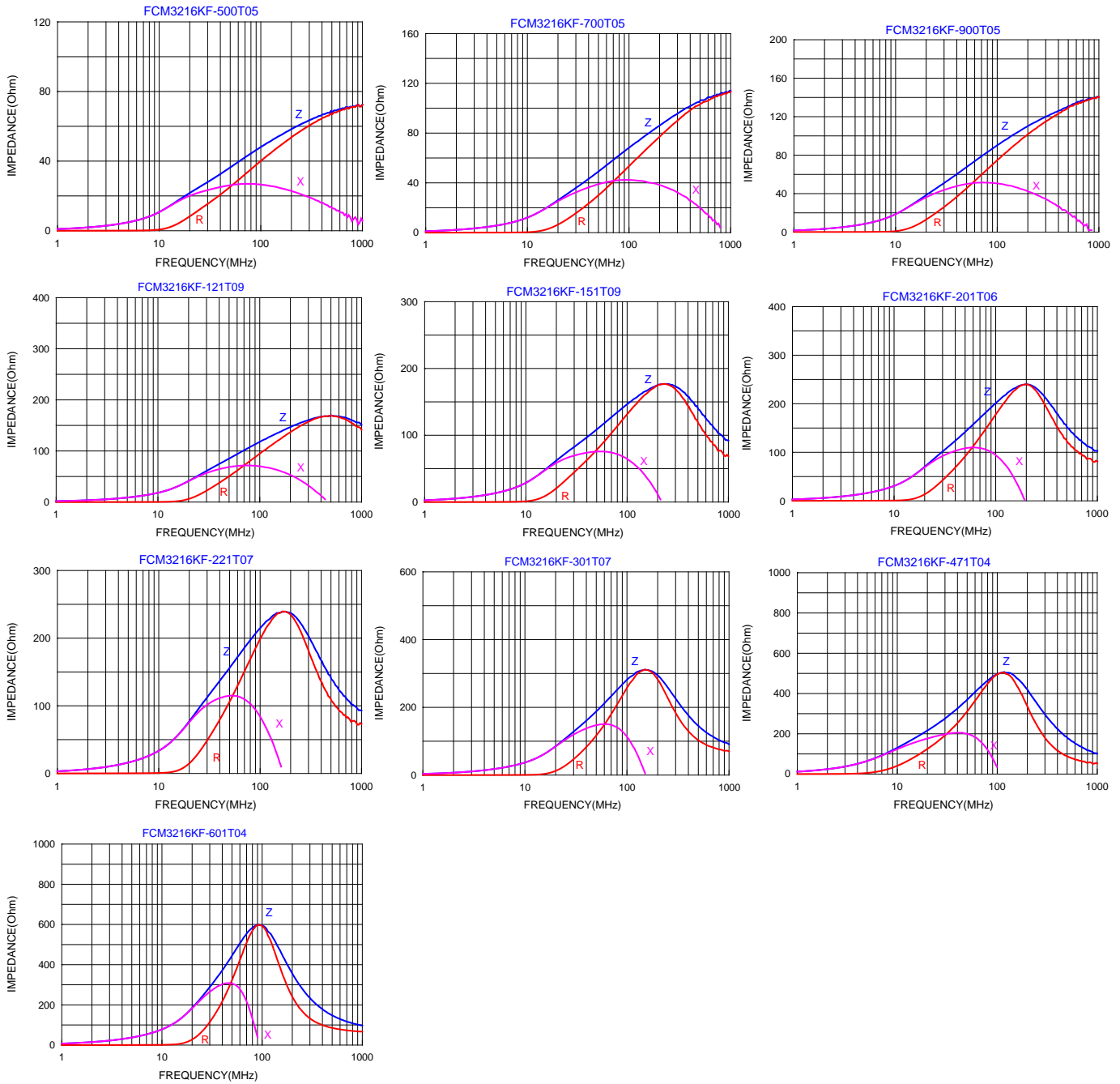

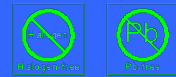

■ Dimensions

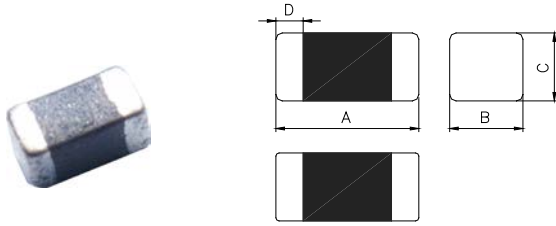

Chip Size	
A	1.00±0.10
B	0.50±0.10
C	0.50±0.10
D	0.25±0.10

Units: mm

■ Specifications

Part Number	Impedance(Ω)		DC Resistance (Ω) max.	Rated Current (mA) max.
	100MHz	1GHz		
GHB1005HF-601T03	600±25%	1400±40%	0.85	300
GHB1005HF-102T02	1000±25%	2000±40%	1.25	250
GHB1005HF-152T02	1500±25%	—	1.50	200
GHB1005HF-182T02	1800±25%	—	2.00	200

■ Impedance-Frequency Characteristics (Typical)

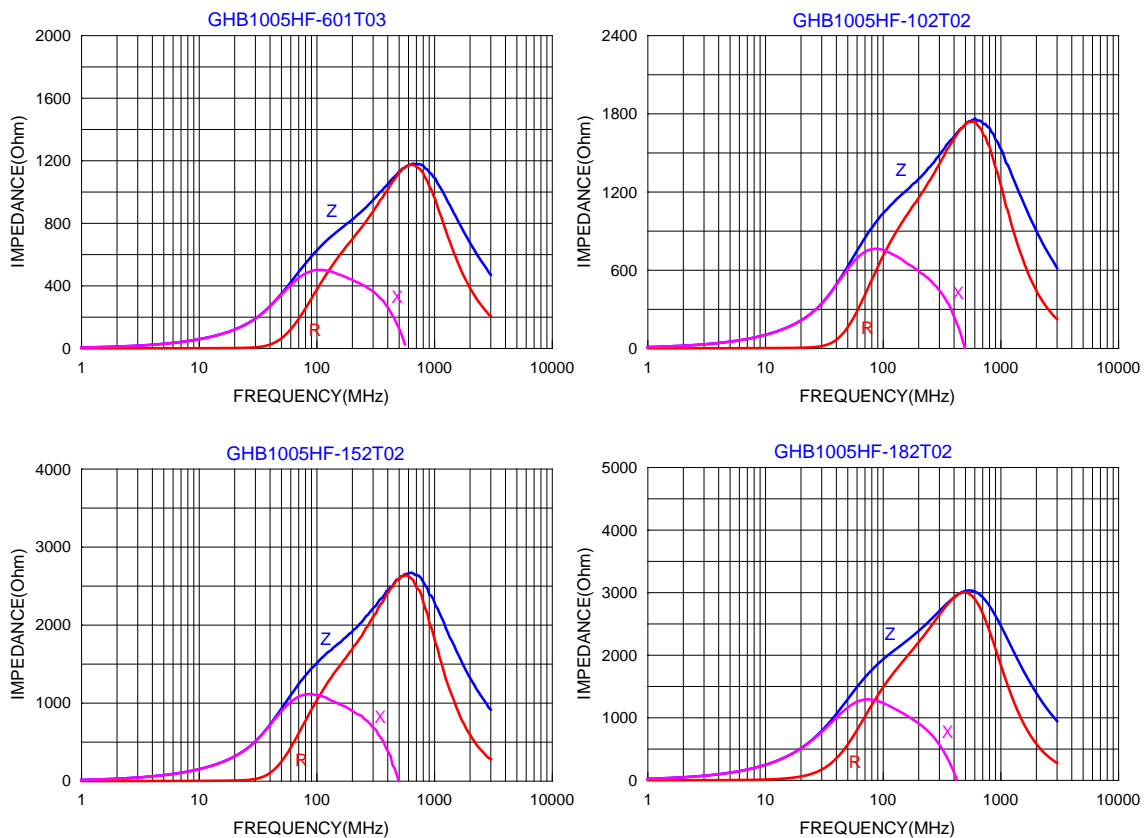



■ Dimensions

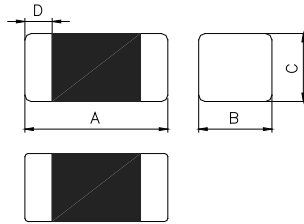

Chip Size	
A	0.60±0.03
B	0.30±0.03
C	0.30±0.03
D	0.15±0.05

Units: mm

■ Specifications

Part Number	Impedance (Ω)	Test Frequency (MHz)	DC Resistance (Ω) max.	Rated Current (mA) max.
HCB0603WF-100T13	10±25%	100	0.03	1300
HCB0603WF-220T10	22±25%	100	0.065	1000
HCB0603WF-330T10	33±25%	100	0.07	1000
HCB0603WF-800T10	80±25%	100	0.12	1000
HCB0603WF-121T08	120±25%	100	0.15	850

■ Impedance-Frequency Characteristics (Typical)

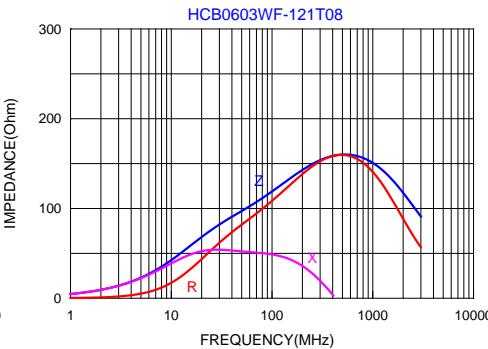
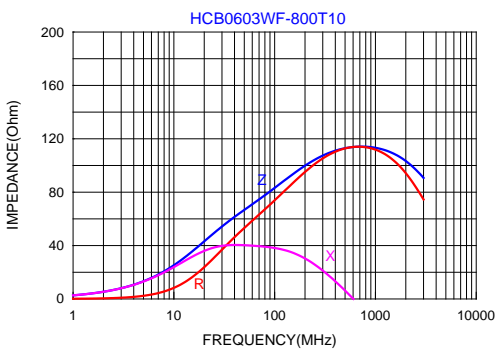
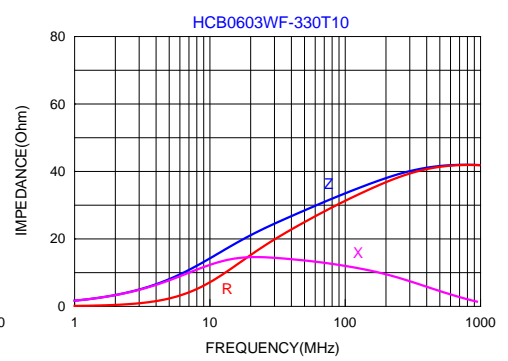
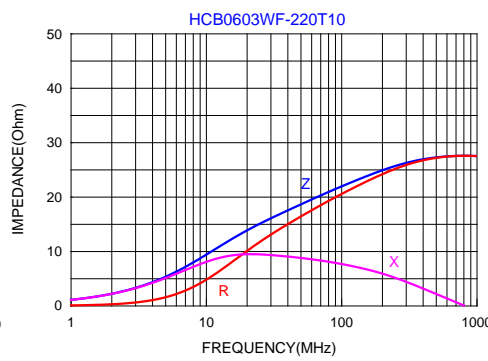
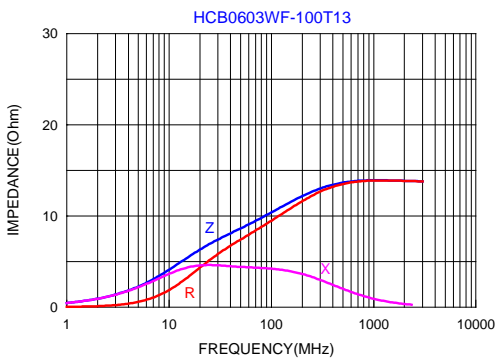



■ Dimensions

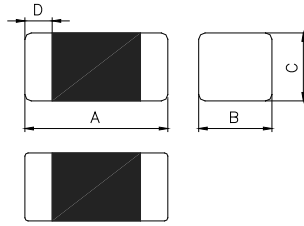

Chip Size	
A	1.00±0.10
B	0.50±0.10
C	0.50±0.10
D	0.25±0.10

Units: mm

■ Specifications

Part Number	Impedance (Ω)	Test Frequency (MHz)	DC Resistance (Ω) max.	Rated Current (mA) max.
HCB1005MF-100T25	10±25%	100	0.050	2500
HCB1005KF-121T20	120±25%	100	0.095	2000
HCB1005KF-221T15	220±25%	100	0.150	1500
HCB1005PF-330T30	33±25%	100	0.022	3000
HCB1005PF-600T25	60±25%	100	0.032	2500
HCB1005PF-800T23	80±25%	100	0.038	2300

■ Impedance-Frequency Characteristics (Typical)

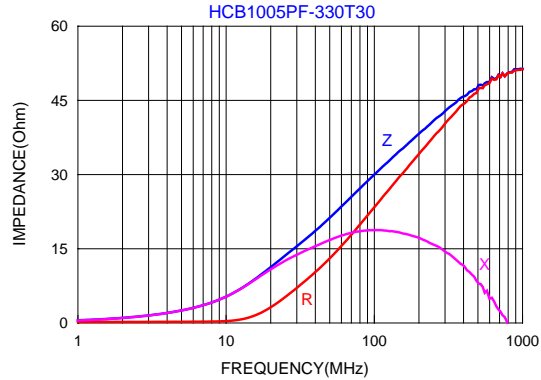
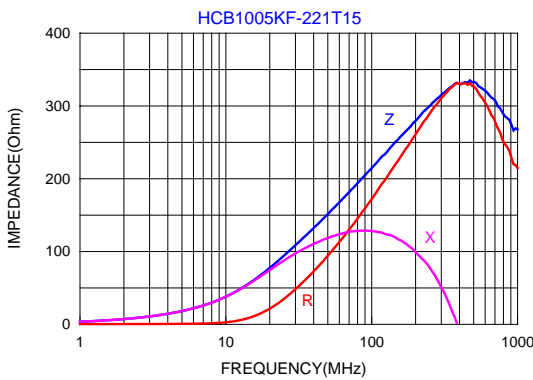
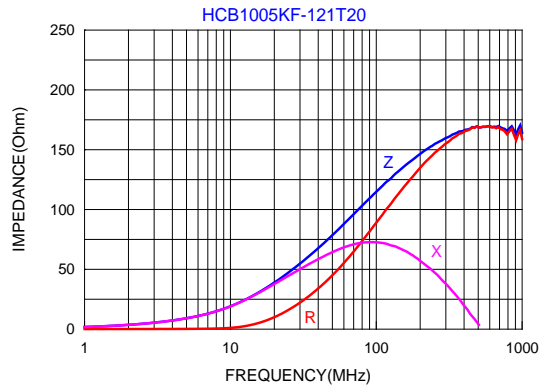
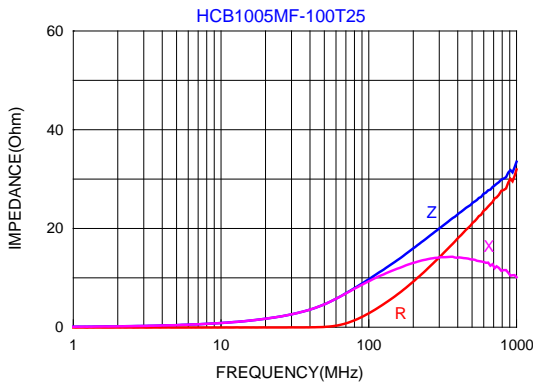



■ Impedance-Frequency Characteristics (Typical)

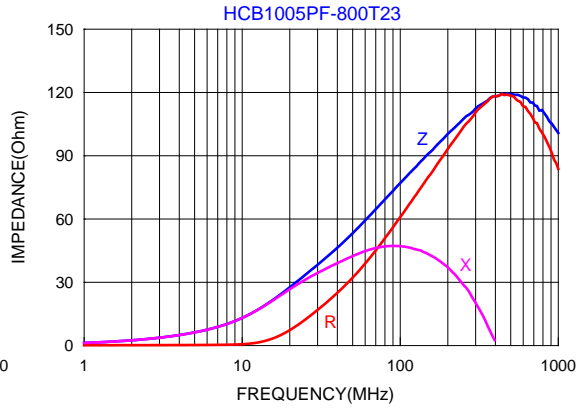
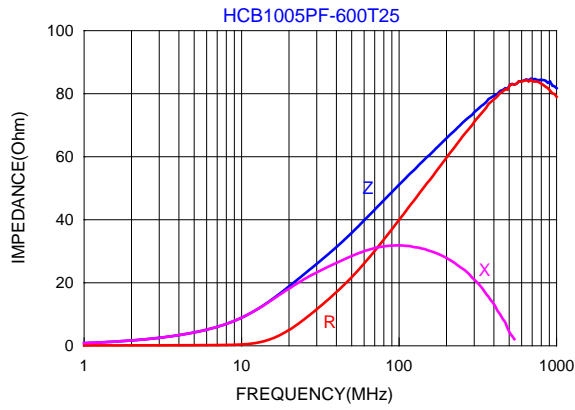



■ Dimensions

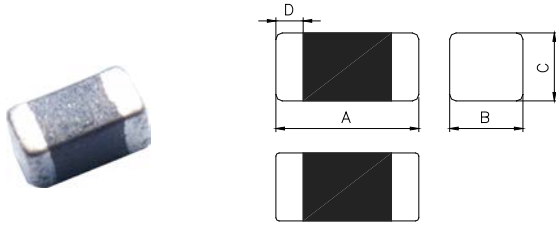

Chip Size	
A	1.60±0.15
B	0.80±0.15
C	0.80±0.15 0.60±0.15
D	0.30±0.20

Units: mm

■ Specifications

Part Number	Impedance (Ω)	Test Frequency (MHz)	DC Resistance (Ω) max.	Rated Current (mA) max.	Height (mm) max.
HCB1606ZF-260T60	26±25%	100	0.01	6000	0.75
HCB1608KF-300T30	30±25%	100	0.04	3000	0.95
HCB1608KF-800T30	80±25%	100	0.04	3000	0.95
HCB1608KF-121T20	120±25%	100	0.10	2000	0.95
HCB1608KF-151T20	150±25%	100	0.10	2000	0.95
HCB1608KF-221T20	220±25%	100	0.10	2000	0.95
HCB1608KF-301T10	300±25%	100	0.20	1000	0.95
HCB1608KF-471T10	470±25%	100	0.20	1000	0.95
HCB1608KF-601T10	600±25%	100	0.20	1000	0.95

■ Impedance-Frequency Characteristics (Typical)

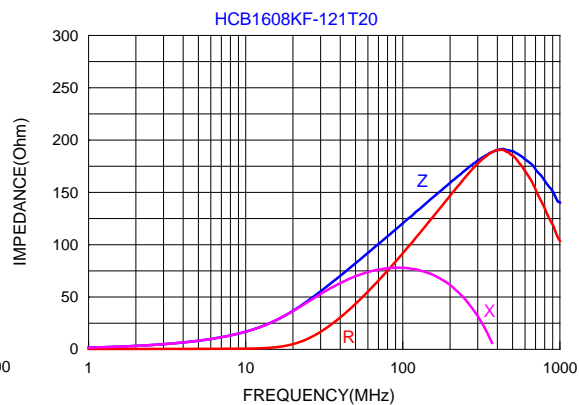
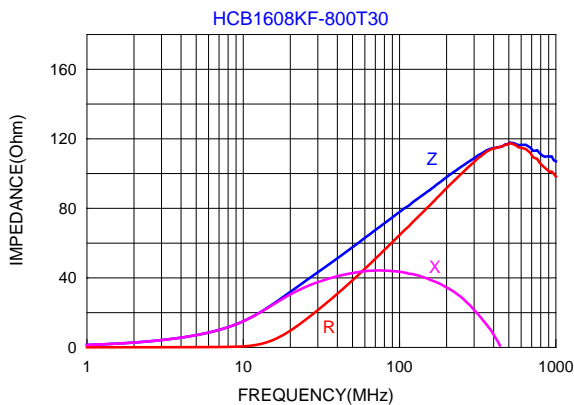
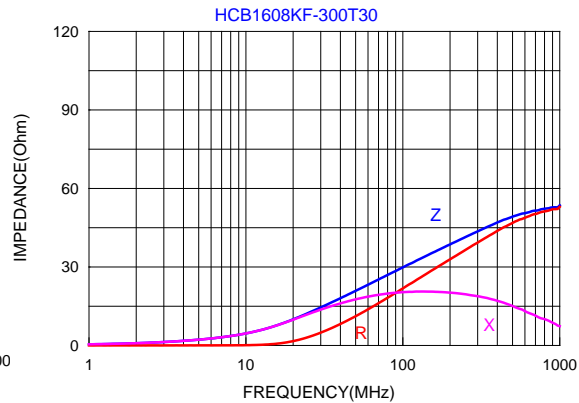
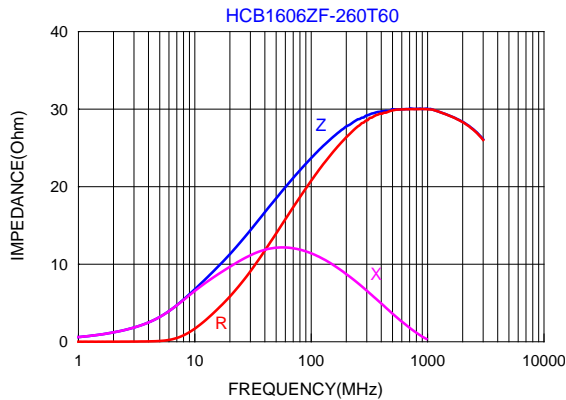



■ Impedance-Frequency Characteristics (Typical)

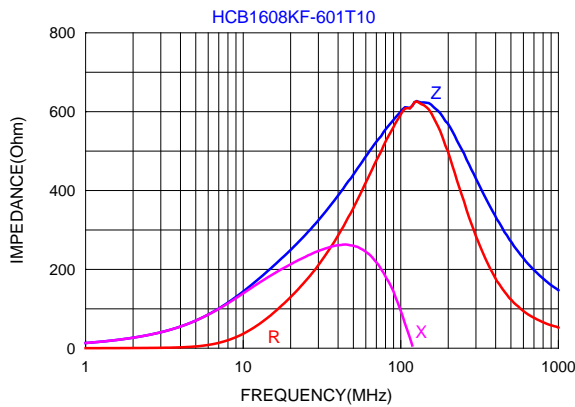
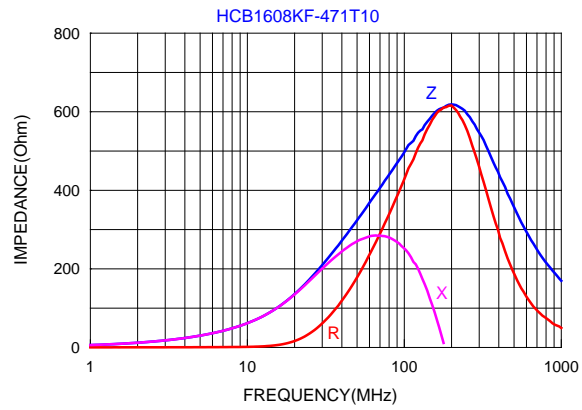
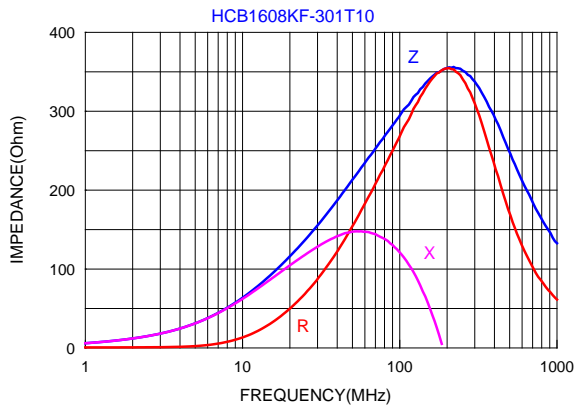
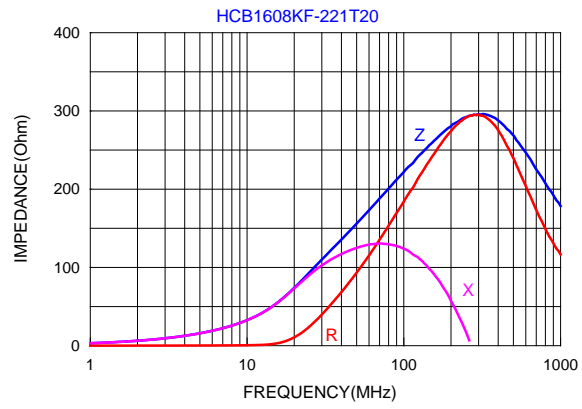
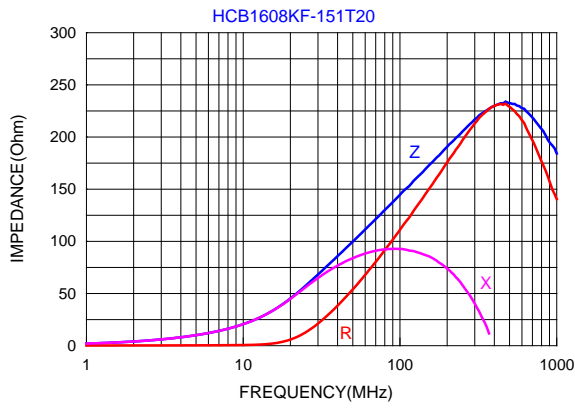

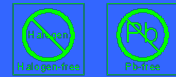

■ Dimensions

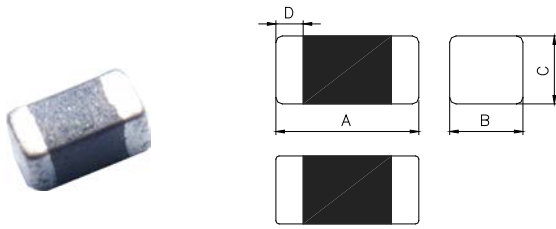

Chip Size	
A	2.00±0.20
B	1.25±0.20
C	0.85±0.20
D	0.50±0.30

Units: mm

■ Specifications

Part Number	Impedance (Ω)	Test Frequency (MHz)	DC Resistance (Ω) max.	Rated Current (mA) max.
HCB2012KF-300T30	30±25%	100	0.04	3000
HCB2012KF-800T30	80±25%	100	0.04	3000
HCB2012KF-121T20	120±25%	100	0.10	2000
HCB2012KF-151T20	150±25%	100	0.10	2000
HCB2012KF-221T20	220±25%	100	0.10	2000
HCB2012KF-301T10	300±25%	100	0.20	1000
HCB2012KF-471T10	470±25%	100	0.20	1000
HCB2012KF-601T10	600±25%	100	0.20	1000

■ Impedance-Frequency Characteristics (Typical)

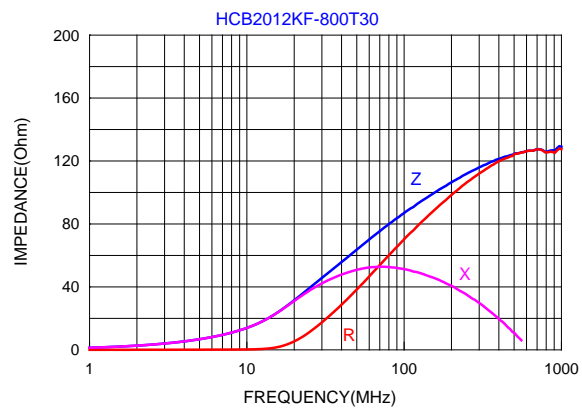
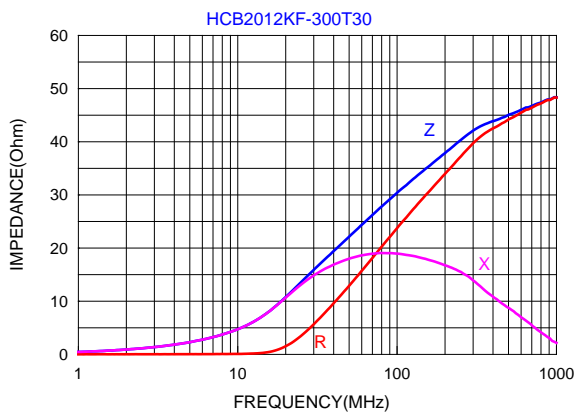



■ Impedance-Frequency Characteristics (Typical)

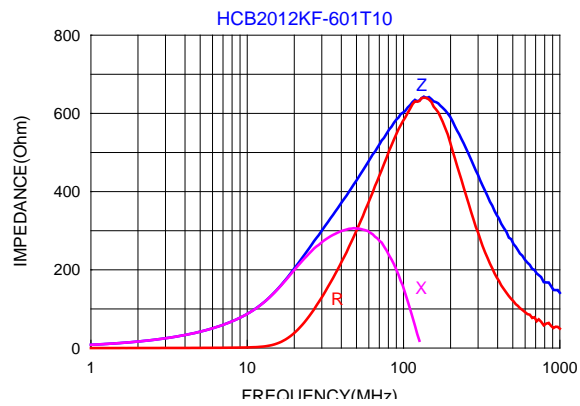
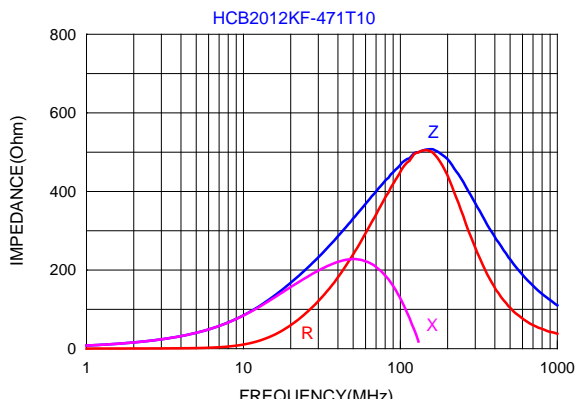
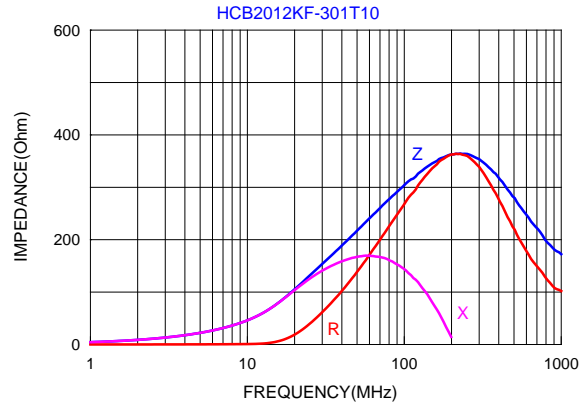
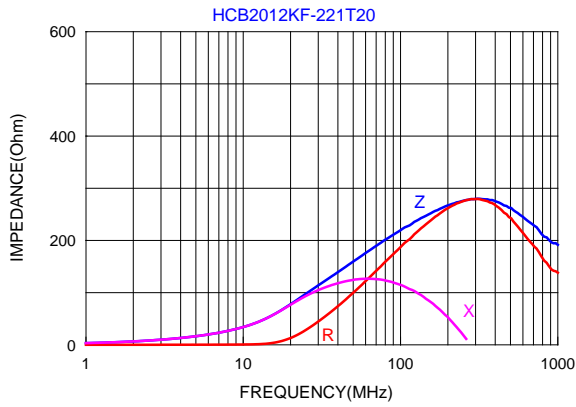
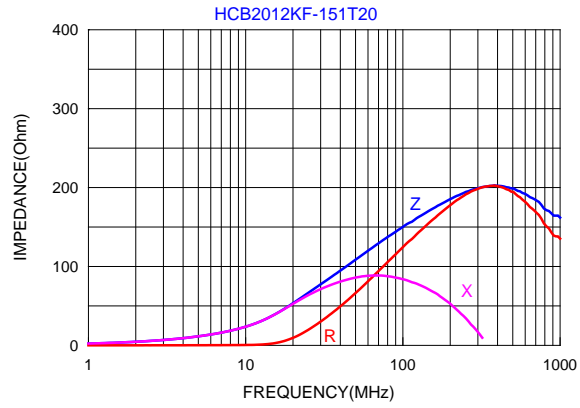
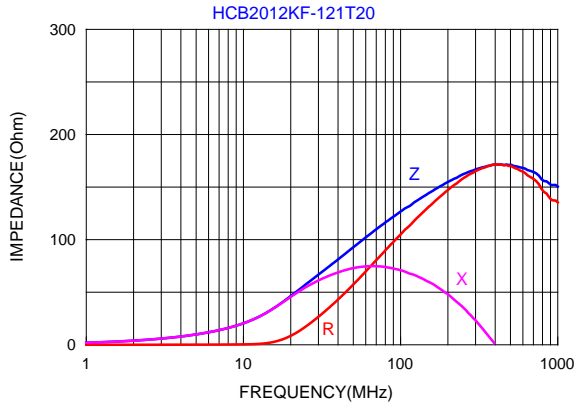

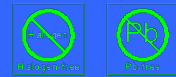

■ Dimensions

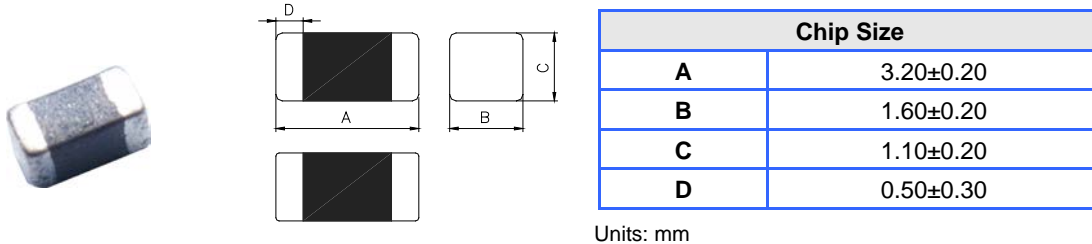

Units: mm

■ Specifications

Part Number	Impedance (Ω)	Test Frequency (MHz)	DC Resistance (Ω) max.	Rated Current (mA) max.
HCB3216KF-300T30	30±25%	100	0.04	3000
HCB3216KF-500T30	50±25%	100	0.04	3000
HCB3216KF-800T30	80±25%	100	0.04	3000
HCB3216KF-121T20	120±25%	100	0.10	2000
HCB3216KF-151T20	150±25%	100	0.10	2000
HCB3216KF-301T10	300±25%	100	0.20	1000
HCB3216KF-471T10	470±25%	100	0.20	1000
HCB3216KF-501T30	500±25%	100	0.04	3000
HCB3216KF-601T20	600±25%	100	0.10	2000

■ Impedance-Frequency Characteristics (Typical)

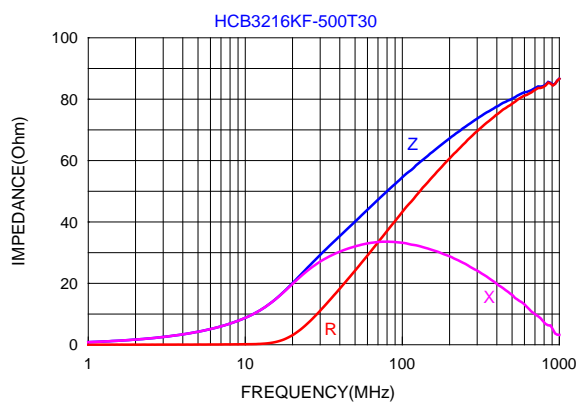
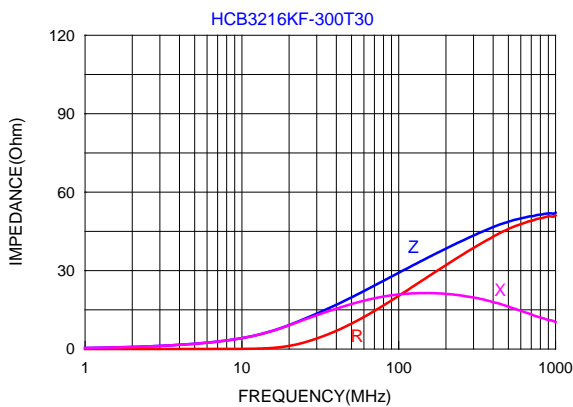

High Current Ferrite Chip Beads

HCB 3216 Series (1206 inch)



■ Impedance-Frequency Characteristics (Typical)

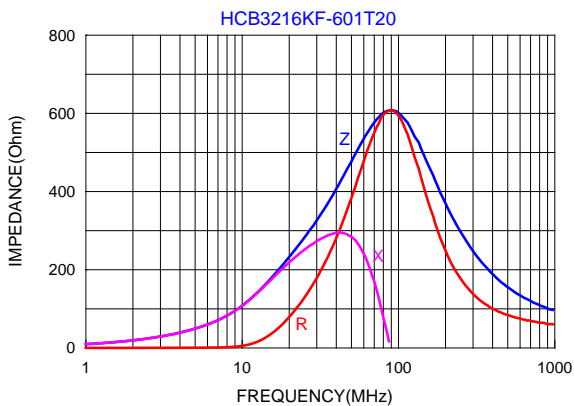
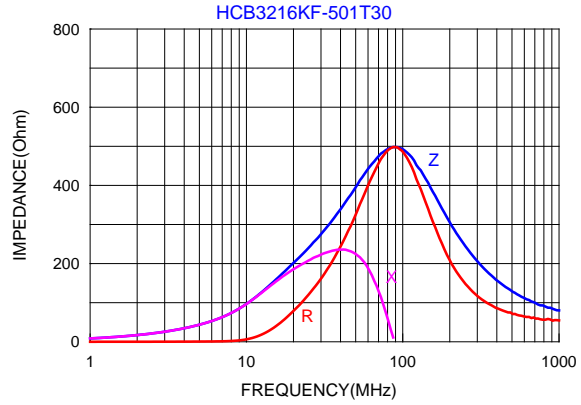
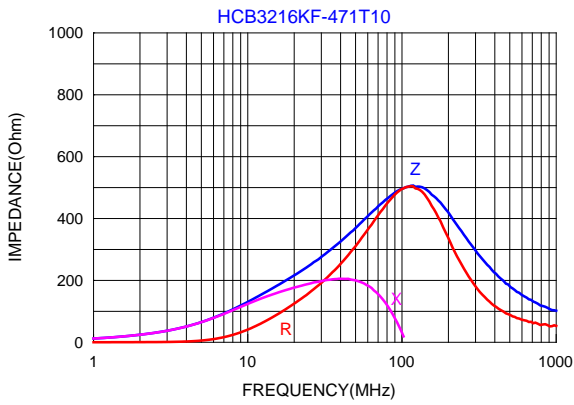
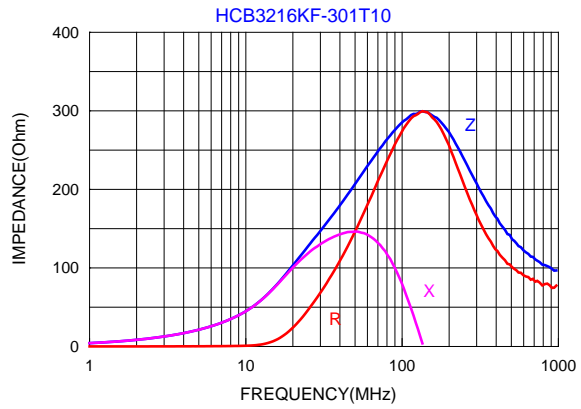
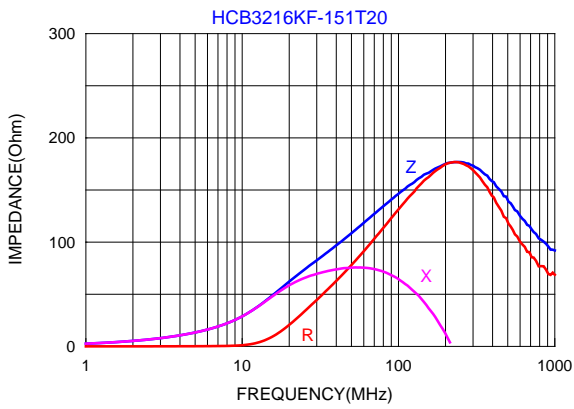
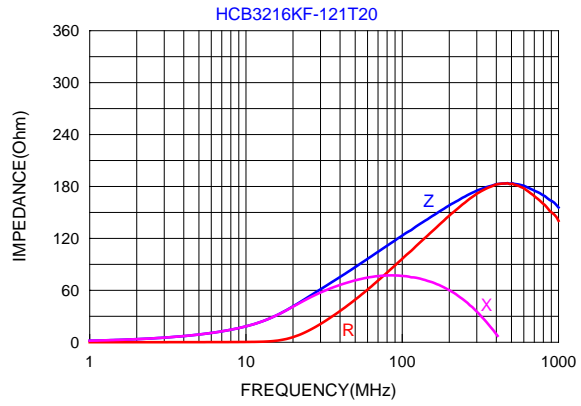
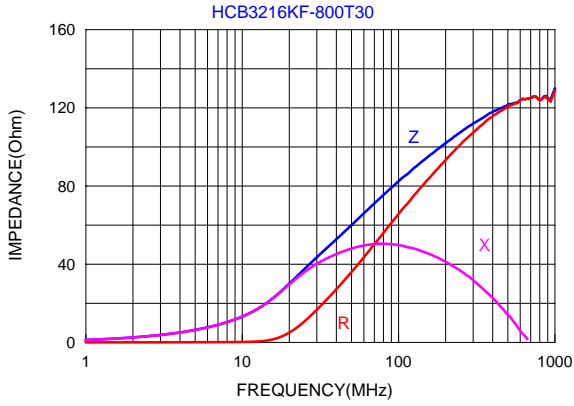

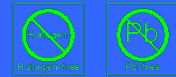

■ Dimensions

Chip Size	
A	4.50±0.20
B	1.60±0.20
C	1.60±0.20
D	0.50±0.30

Units: mm

■ Specifications

Part Number	Impedance (Ω)	Test Frequency (MHz)	DC Resistance (Ω) max.	Rated Current (mA) max.
HCB4516KF-600T60	60±25%	100	0.01	6000
HCB4516KF-800T30	80±25%	100	0.04	3000

■ Impedance-Frequency Characteristics (Typical)

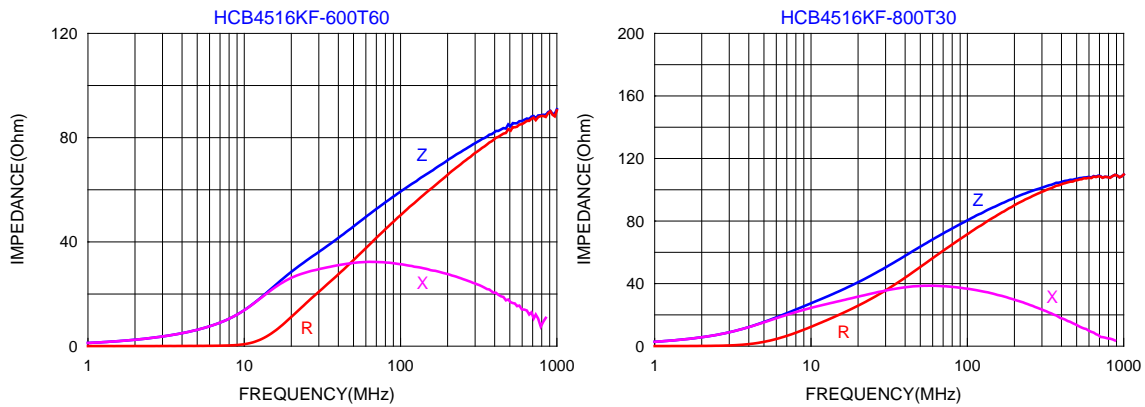

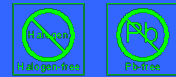

■ Dimensions

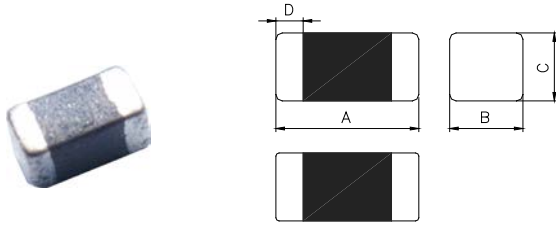

Chip Size	
A	4.50±0.20
B	3.20±0.20
C	1.50±0.20
D	0.50±0.30

Units: mm

■ Specifications

Part Number	Impedance (Ω)	Test Frequency (MHz)	DC Resistance (Ω) max.	Rated Current (mA) max.
HCB4532KF-800T60	80±25%	100	0.01	6000
HCB4532KF-121T50	120±25%	100	0.02	5000
HCB4532KF-131T30	130±25%	100	0.04	3000
HCB4532KF-151T50	150±25%	100	0.02	5000
HCB4532MF-681T40	680±25%	100	0.03	4000
HCB4532MF-132T30	1300±25%	100	0.06	3000

■ Impedance-Frequency Characteristics (Typical)

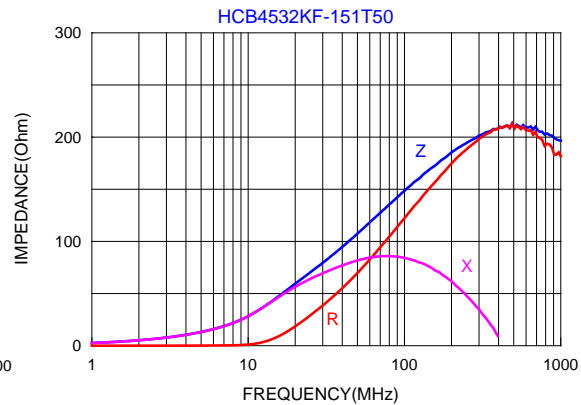
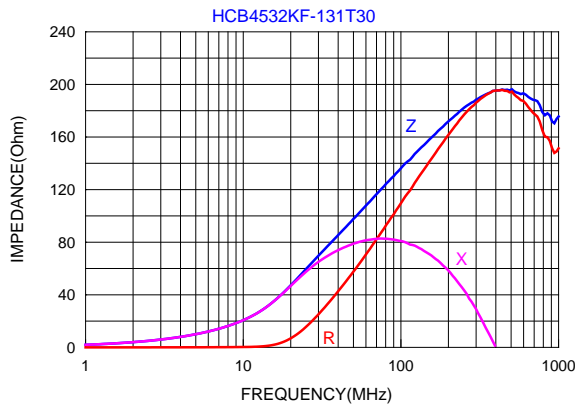
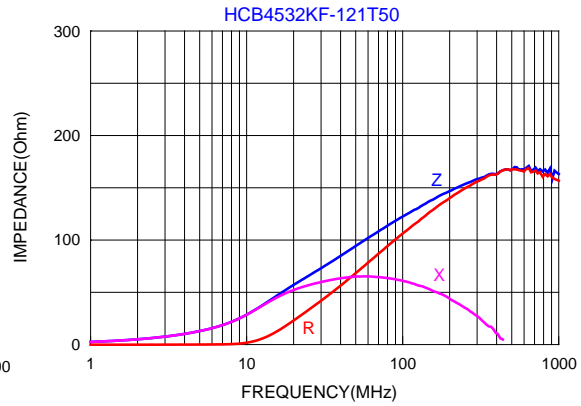
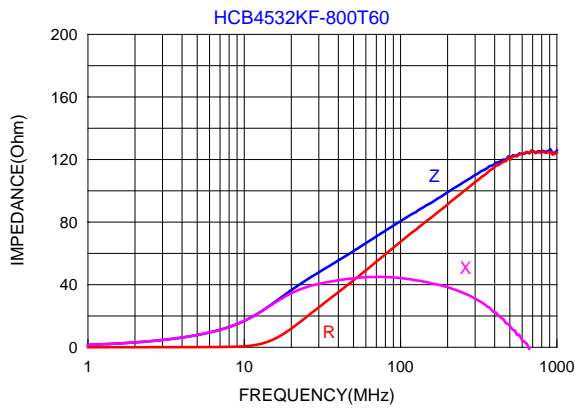



■ Impedance-Frequency Characteristics (Typical)

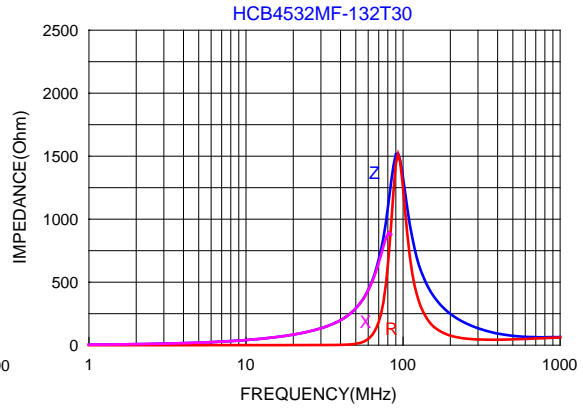
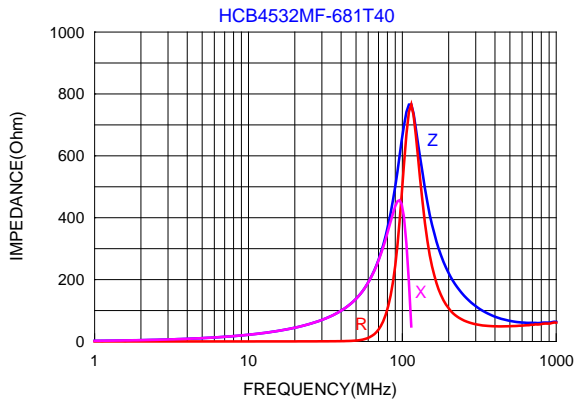



■ Dimensions

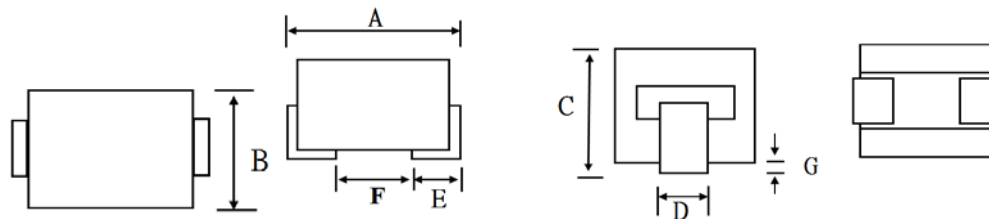

Dimensions: W5 BPH323025						
A(m/m)	B(m/m)	C(m/m)	G(m/m)	D(m/m)	E(m/m)	F(m/m)
3.08 +0.10 -0.15	2.90 ±0.10	2.20 ±0.10	0.00~0.11	0.85 +0.10 -0.05	0.8 +0.20 -0.30	1.20Min

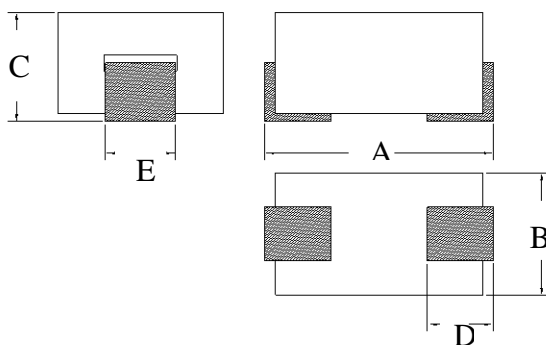

Dimensions: C8B 403025					Dimensions: C8B 853025				
A(m/m)	B(m/m)	C(m/m)	D(m/m)	E(m/m)	A(m/m)	B(m/m)	C(m/m)	D(m/m)	E(m/m)
4.30~ 5.10	2.80~ 3.20	2.70~ 3.10	1.00~ 2.00	1.27 ±0.15	9.00 ±0.40	3.10 ±0.15	2.80 ±0.25	1.50 ±0.50	1.27 ±0.20

■ Specifications

Part Number	Impedance ohm at 25 MHz	Impedance ohm at 100 MHz	DC Resistance (mΩ) max.	Rated Current (A) max. ΔT= 40°C
W5 BPH 323025	23±25%	39±25%	0.6	15
C8B BPH 403025	22 min	47±20%	0.6	10
C8B BPH 853025	45 min	75 min	1.0	13

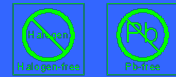

■ Dimensions

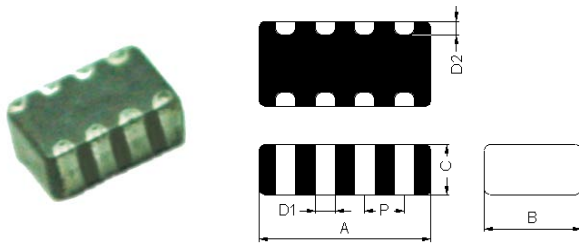

Chip Size	
A	3.20±0.20
B	1.60±0.20
C	0.90±0.20
D1	0.40±0.15
D2	0.30±0.10
P	0.80±0.10

Units: mm

■ Specifications

Part Number	Impedance (Ω)	Test Frequency (MHz)	DC Resistance (Ω) max.	Rated Current (mA) max.
FCA3216KF4-300T05	30±25%	100	0.20	500
FCA3216KF4-600T04	60±25%	100	0.25	400
FCA3216KF4-121T03	120±25%	100	0.30	350
FCA3216KF4-301T02	300±25%	100	0.40	250
FCA3216KF4-601T02	600±25%	100	0.50	200
FCA3216KF4-102T01	1000±25%	100	0.75	150
FCA3216MF4-300T04	30±25%	100	0.25	400
FCA3216MF4-600T03	60±25%	100	0.30	300
FCA3216MF4-121T02	120±25%	100	0.40	250
FCA3216MF4-301T02	300±25%	100	0.50	200

■ Impedance-Frequency Characteristics (Typical)

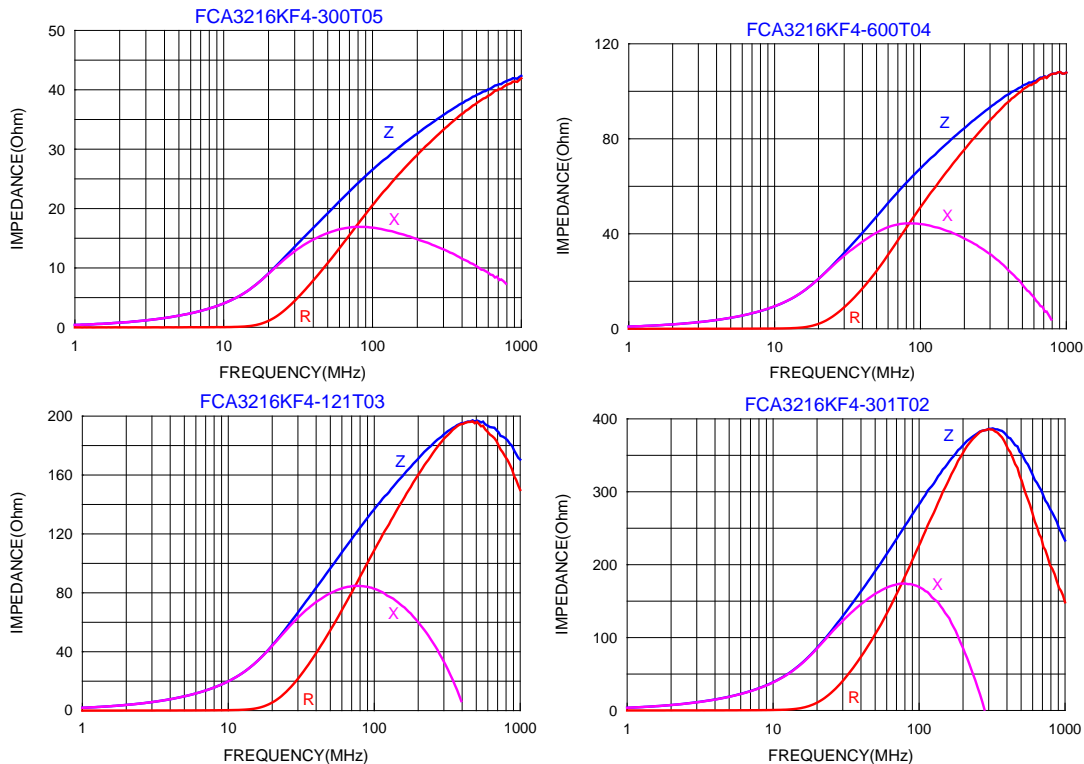



■ Impedance-Frequency Characteristics (Typical)

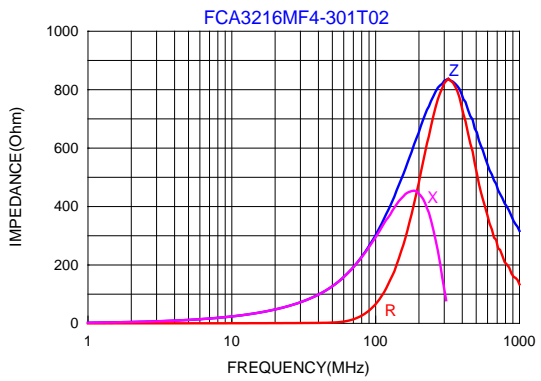
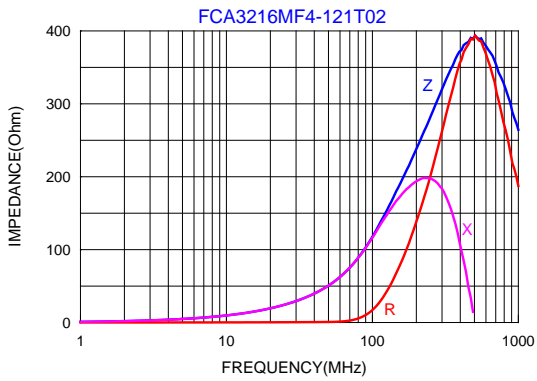
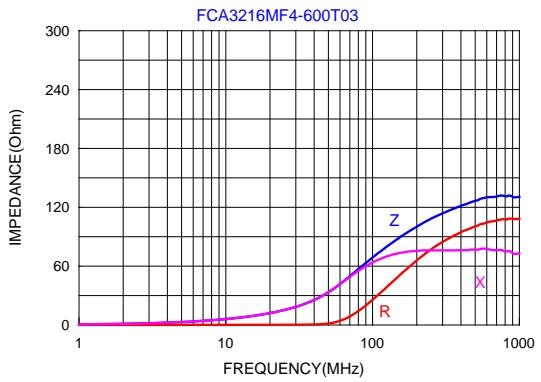
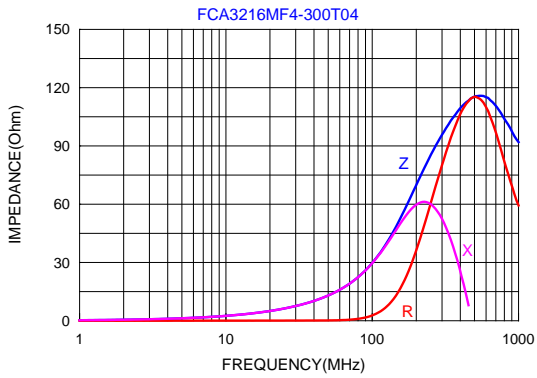
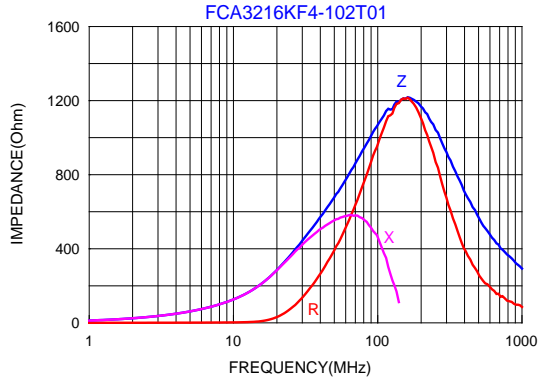
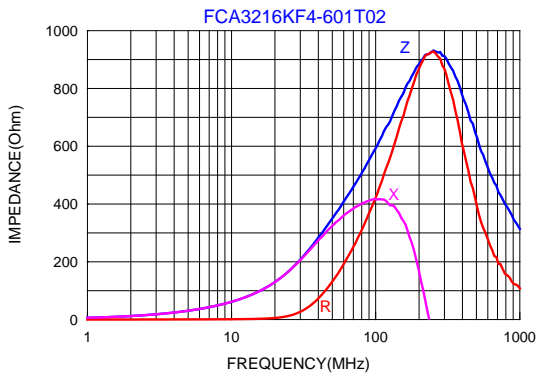



■ Dimensions

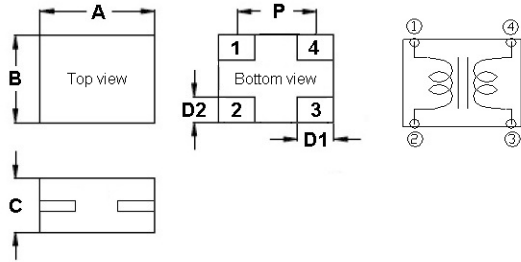

Dimensions	
A	0.67±0.05
B	0.52±0.05
C	0.32±0.05
P	0.45±0.05
D1	0.20±0.05
D2	0.15±0.10

Units: mm

■ Specifications

Tai-Tech Part Number	Common Mode Impedance (Ω)	Test Frequency (MHz)	Rated Voltage (Vdc) max.	Insulation Resistance (MΩ) min.	Cut-off Frequency (GHz) typ.	DC Resistance (Ω) max.	Rated Current (mA) max.
MCF0605BF2-120T01	12±5 Ω	250mV / 100	5	10	10	2.0	100
MCF0605BF2-900T01	90±30%	250mV / 100	5	10	3	6.0	100

● Rated current: based on temperature rise test

■ Impedance-Frequency Characteristics (Typical)

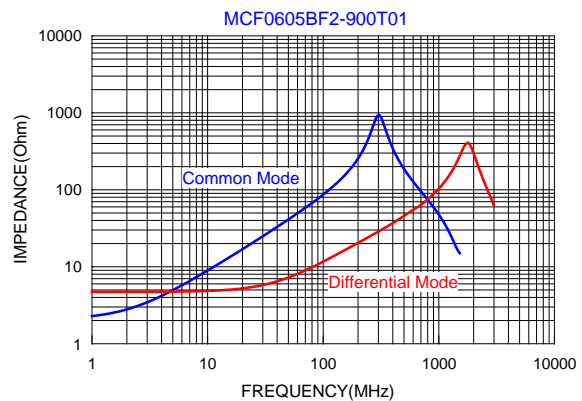
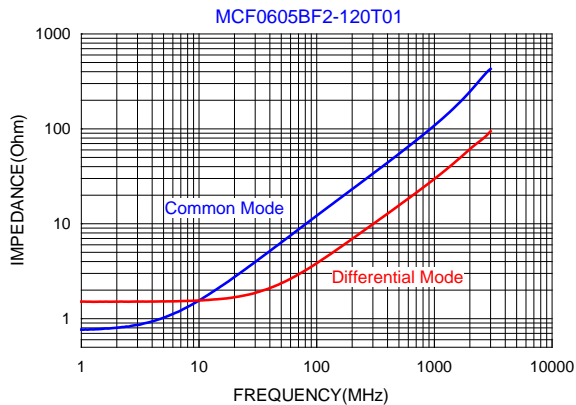

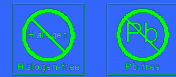

■ Dimensions

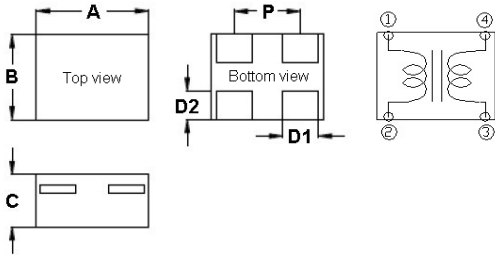

Dimensions	
A	0.85±0.05
B	0.65±0.05
C	0.40±0.05
P	0.50±0.10
D1	0.27±0.10
D2	0.20±0.10

Units: mm

■ Specifications

Tai-Tech Part Number	Common Mode Impedance (Ω)	Test Frequency (MHz)	Rated Voltage (Vdc) max.	Insulation Resistance (MΩ) min.	Cut-off Frequency (GHz) typ.	DC Resistance (Ω) max.	Rated Current (mA) max.
MCF0806BF2-120T01	12±5Ω	250mV / 100	5	10	10	2.0	100
MCF0806BF2-900T01	90±25%	250mV / 100	5	10	4	3.5	100

● Rated current: based on temperature rise test

■ Impedance-Frequency Characteristics (Typical)

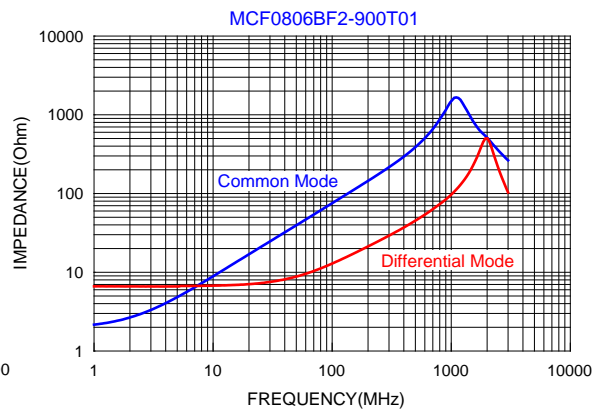
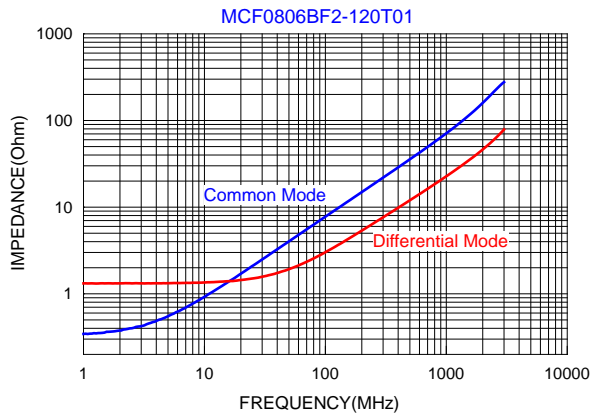

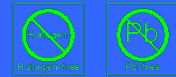

■ Dimensions

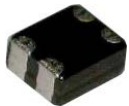
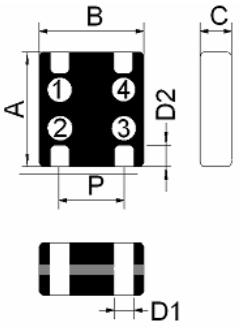
Dimensions	
A	1.25±0.15
B	1.00±0.15
C	0.55±0.10
P	0.55±0.10
D1	0.30±0.10
D2	0.20±0.10

Units: mm

■ Specifications

Part Number	Common Mode Impedance (Ω)	Test Frequency (MHz)	Rated Voltage (Vdc) max.	Insulation Resistance (MΩ) min.	DC Resistance (Ω) max.	Rated Current (mA) max.
MCF1210NF2-400T01	40±25%	100	5	100	2.5	100
MCF1210NF2-900T01	90±25%	100	5	100	4.5	100

● Rated current: based on temperature rise test

■ Impedance-Frequency Characteristics (Typical)

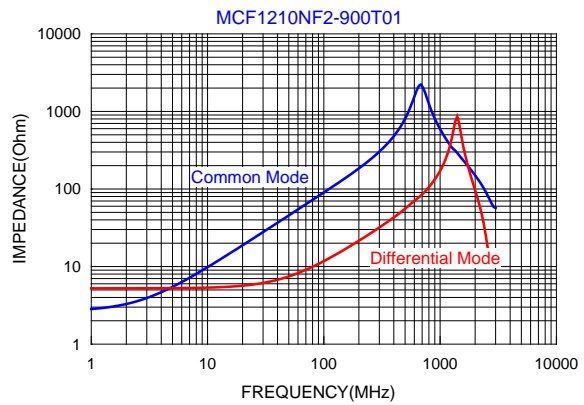
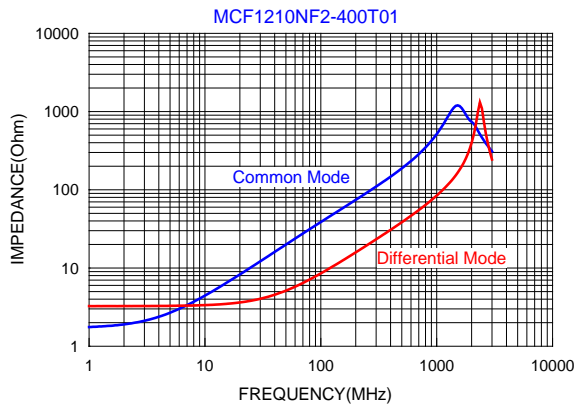



■ Dimensions

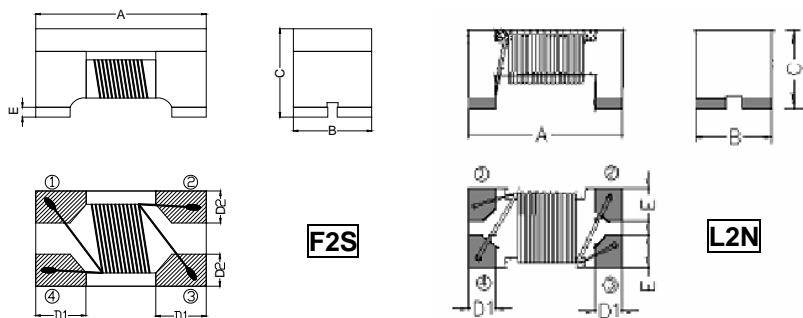

Series	A(mm)	B(mm)	C(mm)	D1(mm)	D2(mm)	E(mm)
F2S	2.0±0.2	1.2±0.2	1.2±0.2	0.50±0.1	0.51±0.1	0.15±0.1
L2N	2.0±0.2	1.2±0.2	0.9±0.1	0.50±0.1	-	0.51±0.1

Unit: mm

■ Specifications

Part Number	Common mode Impedance (Ω)	Test Frequency (MHz)	DC Resistance (Ω) max.	Rated Current (mA)max.	Rated Volt. (Vdc)max.	Withstand Volt. (Vdc) max.	IR (Ω) min.
WCM2012L2NF-670T04	67±25%	100	0.35	400	50	125	10M
WCM2012L2NF-900T04	90±25%	100	0.35	400	50	125	10M
WCM2012L2NF-121T03	120±25%	100	0.45	300	50	125	10M
WCM2012L2NF-181T03	180±25%	100	0.50	300	50	125	10M
WCM2012F2SF-670T04	67±25%	100	0.25	400	50	125	10M
WCM2012F2SF-900T04	90±25%	100	0.30	400	50	125	10M
WCM2012F2SF-121T04	120±25%	100	0.30	400	50	125	10M
WCM2012F2SF-161T03	160±25%	100	0.35	350	50	125	10M
WCM2012F2SF-181T03	180±25%	100	0.35	350	50	125	10M
WCM2012F2SF-201T03	200±25%	100	0.40	300	50	125	10M
WCM2012F2SF-221T03	220±25%	100	0.40	300	50	125	10M
WCM2012F2SF-261T03	260±25%	100	0.40	300	50	125	10M
WCM2012F2SF-361T03	360±25%	100	0.50	300	50	125	10M
WCM2012F2SF-601T03	600±25%	100	0.88	300	50	125	10M
WCM2012F2SF-102T01	1000±25%	100	1.30	100	50	125	10M



■ Impedance-Frequency Characteristics (Typical)

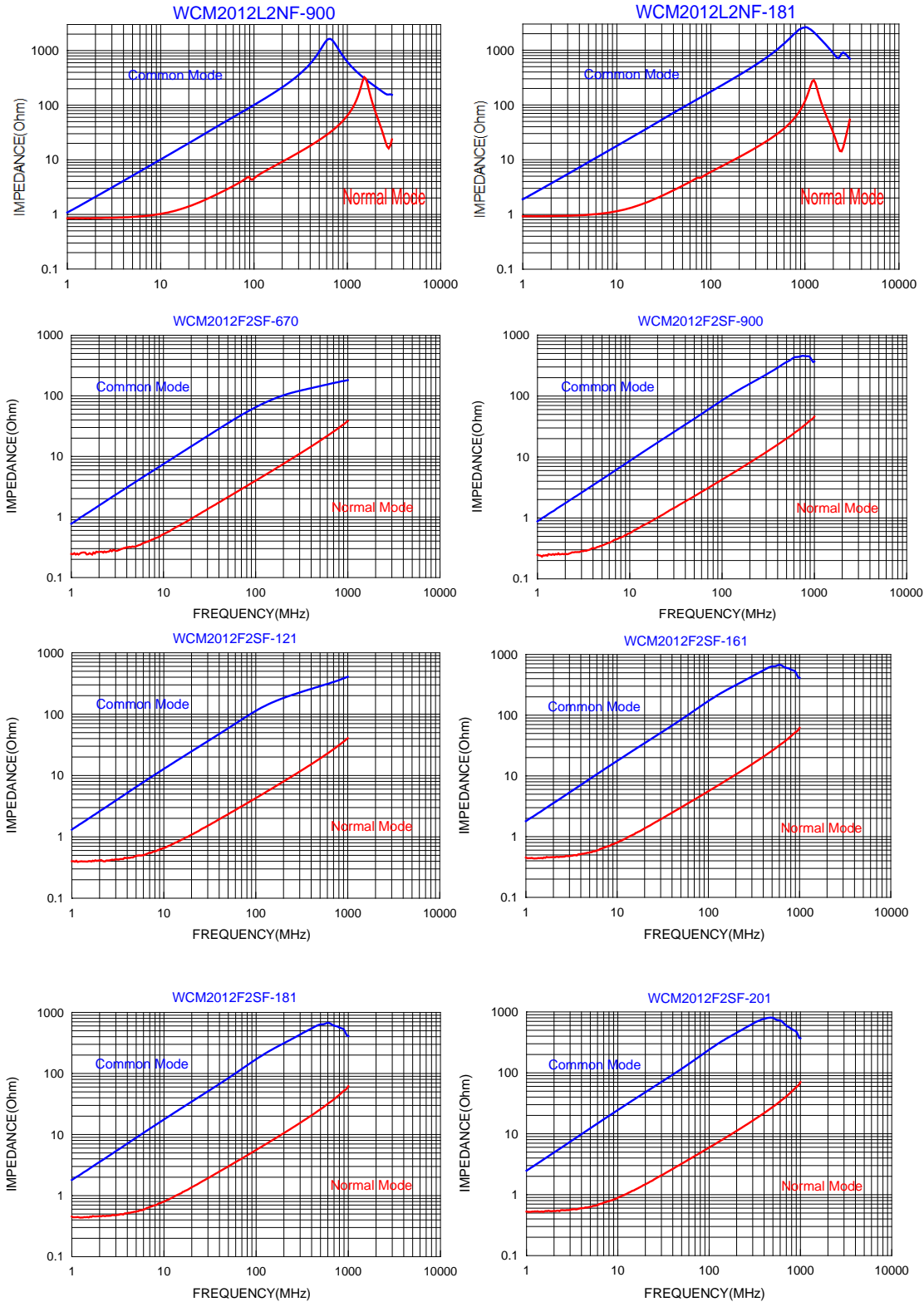

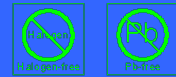

■ Impedance-Frequency Characteristics (Typical)

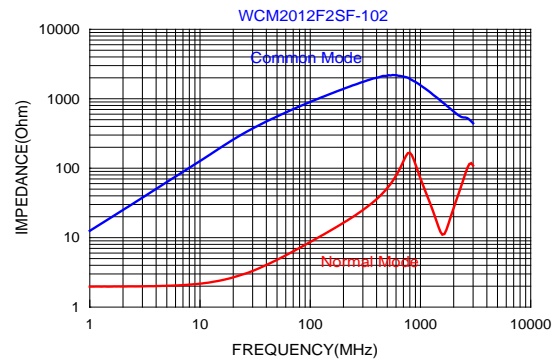
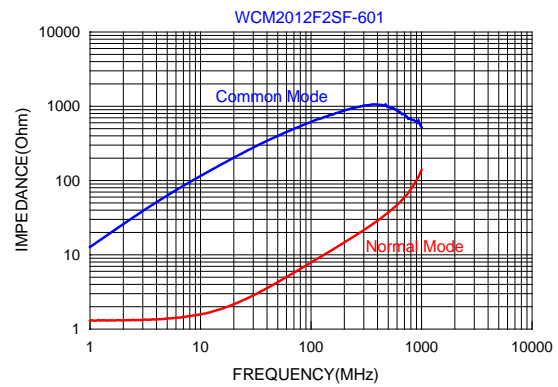
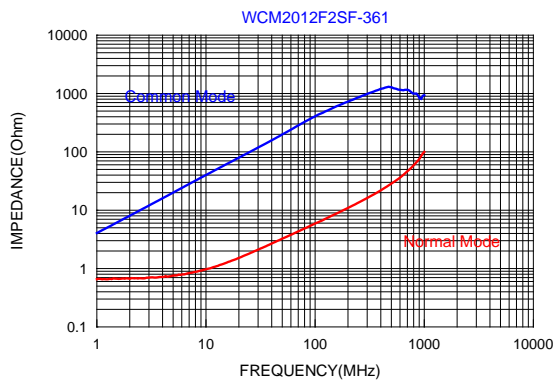
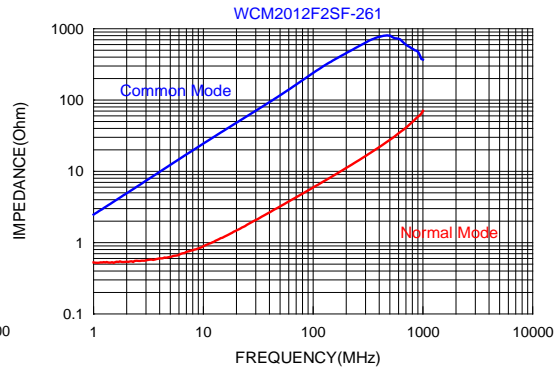
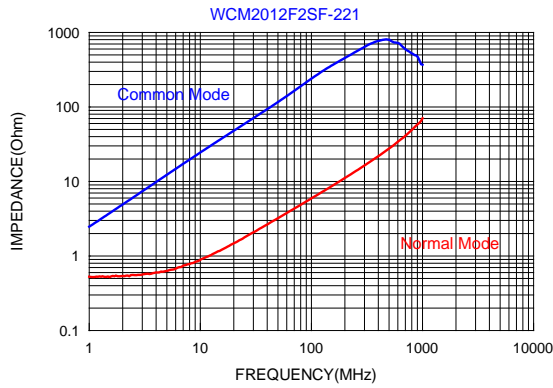

WCM 3216 Series (1206 inch)

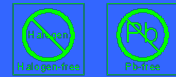

■ Dimensions

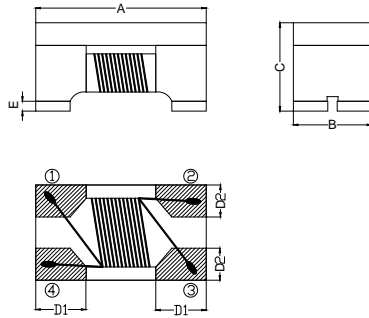

Chip Size	
A	3.20±0.20
B	1.60±0.20
C	2.00±0.20
D1	0.50±0.10
D2	0.50±0.10
E	0.15±0.10

Units: mm

■ Specifications

Part Number	Common mode Impedance (Ω)	Test Frequency (MHz)	DC Resistance (Ω) max.	Rated Current (mA)max.	Rated Volt. (Vdc)max.	Withstand Volt. (Vdc) max.	IR (Ω) min.
WCM3216F2SF-900T04	90±25%	100	0.30	400	50	125	10M
WCM3216F2SF-121T03	120±25%	100	0.30	350	50	125	10M
WCM3216F2SF-161T03	160±25%	100	0.40	350	50	125	10M
WCM3216F2SF-221T03	220±25%	100	0.45	300	50	125	10M
WCM3216F2SF-261T03	260±25%	100	0.50	300	50	125	10M
WCM3216F2SF-361T03	360±25%	100	0.60	300	50	125	10M
WCM3216F2SF-601T03	600±25%	100	0.80	300	50	125	10M
WCM3216F2SF-102T02	1000±25%	100	1.00	200	50	125	10M
WCM3216F2SF-222T02	2200±25%	100	1.20	200	50	125	10M

■ Impedance-Frequency Characteristics (Typical)

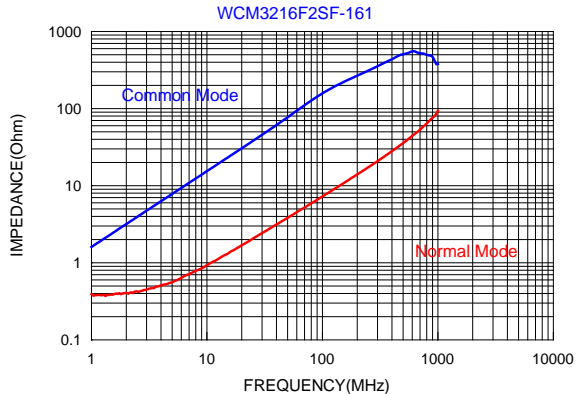
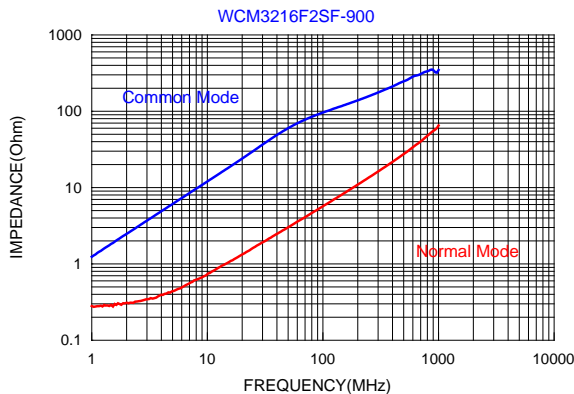



■ Impedance-Frequency Characteristics (Typical)

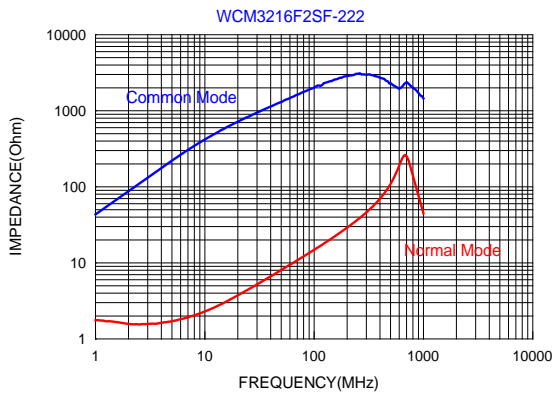
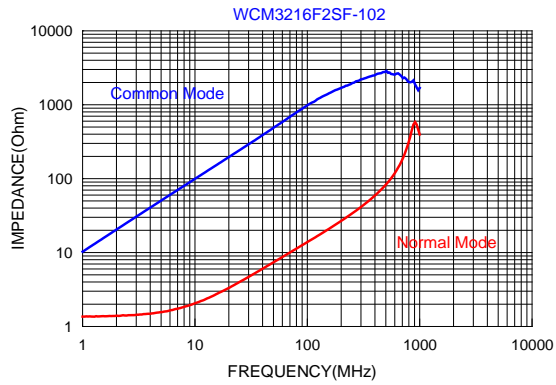
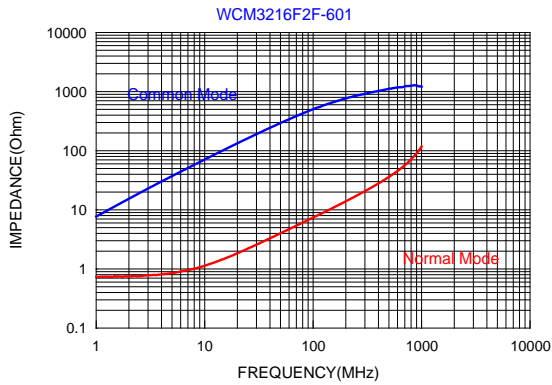
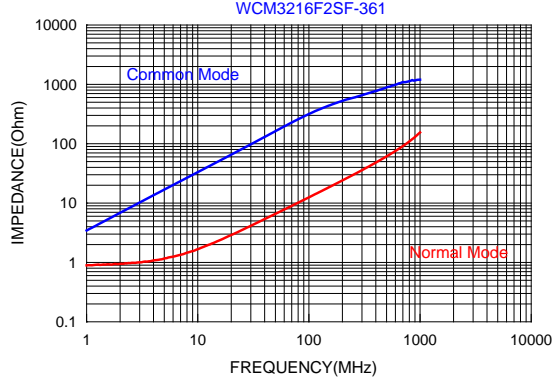
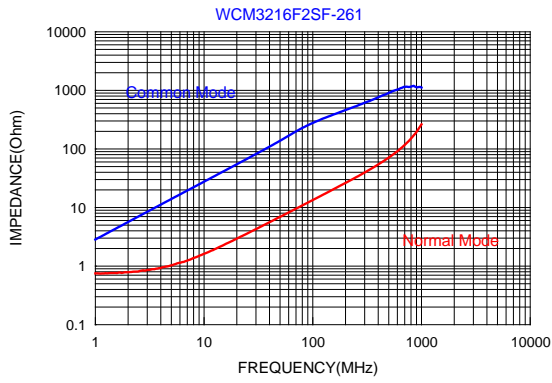
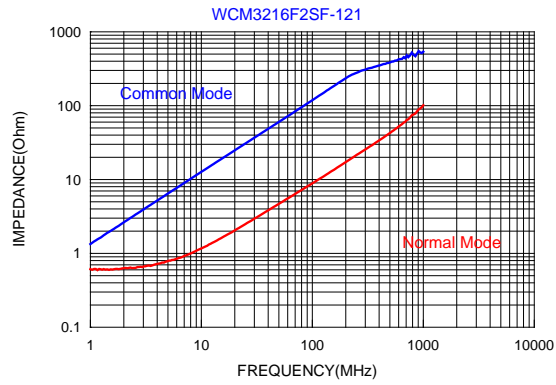
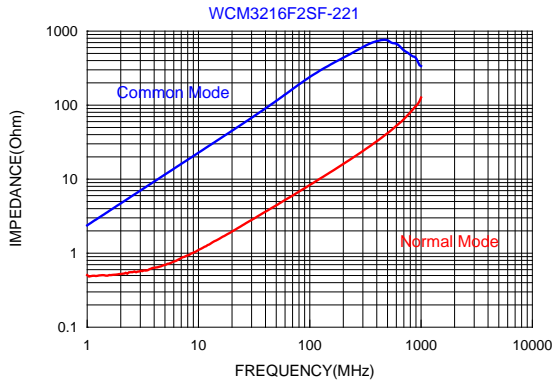

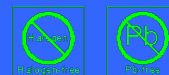

■ Dimensions

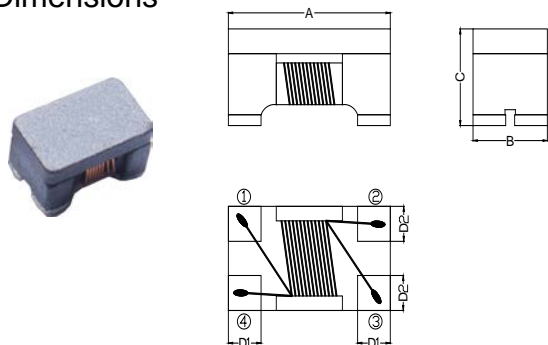

Chip Size	
A	3.20±0.20
B	2.50±0.20
C	2.20±0.20
D1	0.80±0.10
D2	0.90±0.10

Units: mm

■ Specifications

Part Number	Common mode Impedance (Ω)	Test Frequency (MHz)	DC Resistance (Ω) max.	Rated Current (mA)max.	Rated Volt. (Vdc)max.	Withstand Volt. (Vdc) max.	IR (Ω) min.
WCM3225F2SF-900T10	90±25%	100	0.050	1000	50	125	10M
WCM3225F2SF-601T10	600±25%	100	0.20	1000	50	125	10M
WCM3225F2SF-102T04	1000±25%	100	0.30	400	50	125	10M

■ Impedance-Frequency Characteristics (Typical)

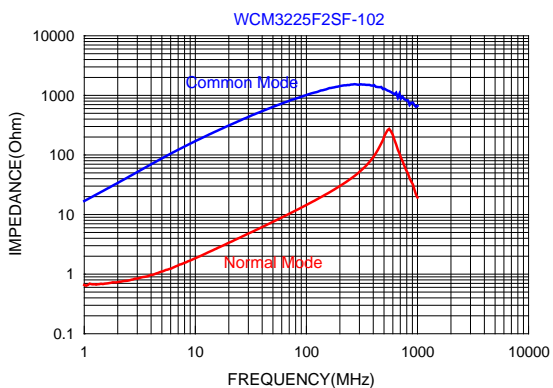
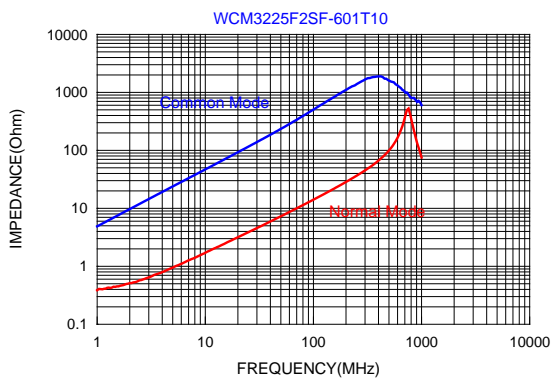
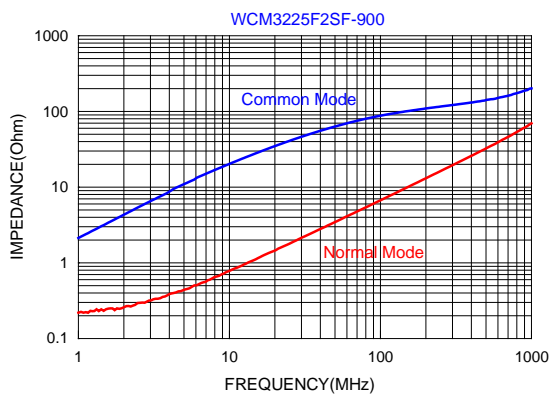



■ Dimensions

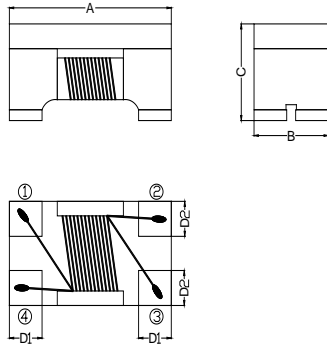

Chip Size	
A	4.50±0.20
B	3.20±0.20
C	2.80±0.20
D1	1.00±0.10
D2	1.20±0.10

Units: mm

■ Specifications

Part Number	Common mode Impedance (Ω)	Test Frequency (MHz)	DC Resistance (Ω) max.	Rated Current (mA)max.	Rated Volt. (Vdc)max.	Withstand Volt. (Vdc) max.	IR (Ω) min.
WCM4532F2SF-900T20	90±25%	100	0.05	2000	50	125	10M
WCM4532F2SF-601T15	600±25%	100	0.24	1500	50	125	10M
WCM4532F2SF-801T10	800±25%	100	0.24	1000	50	125	10M

■ Impedance-Frequency Characteristics (Typical)

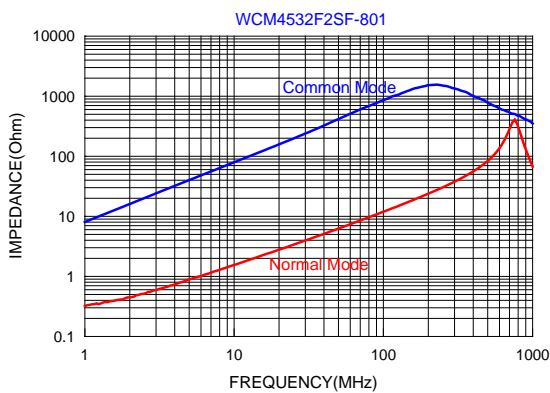
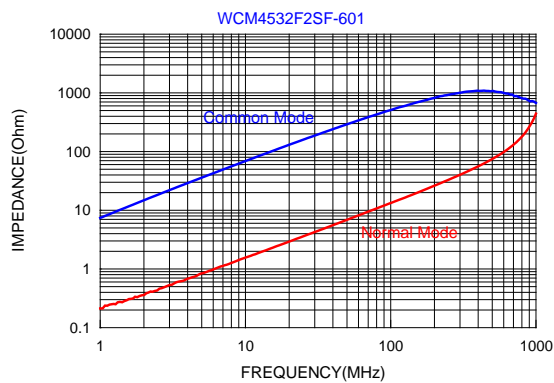
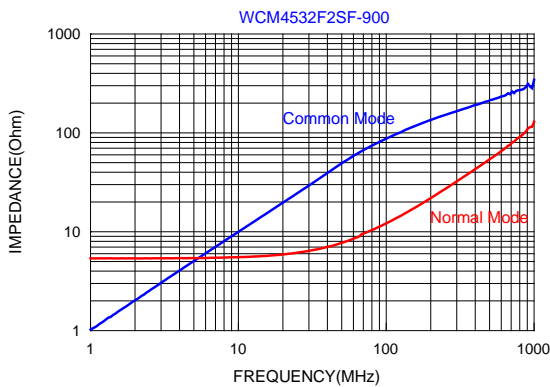



■ Dimensions

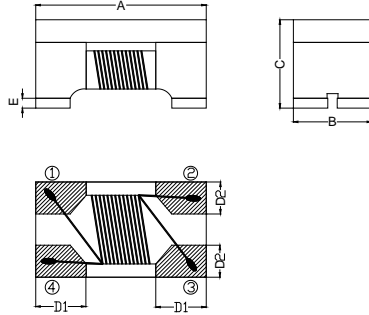

Chip Size	
A	2.00±0.20
B	1.20±0.20
C	1.20±0.20
D1	0.50±0.10
D2	0.51±0.10
E	0.15±0.10

Units: mm

■ Specifications

Part Number	Common mode Impedance (Ω)		Test Frequency (MHz)	DC Resistance (Ω) max.	Rated Current (mA)max.	Rated Volt. (Vdc)max.	Withstand Volt. (Vdc) max.	IR (Ω) min.
	67 typ.	50 min.						
HDMI2012F2SF-670T04	67 typ.	50 min.	100	0.30	400	50	125	10M
HDMI2012F2SF-900T04	90 typ.	65 min.	100	0.30	400	50	125	10M

■ Impedance-Frequency Characteristics (Typical)

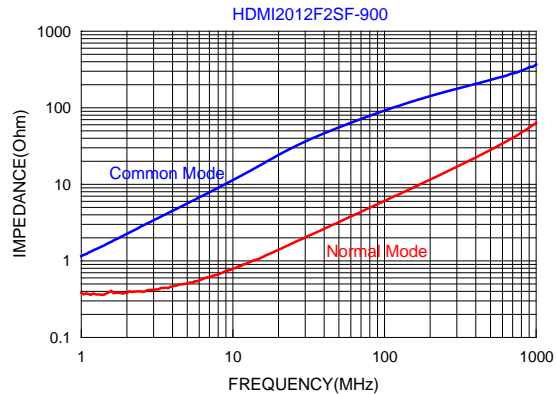
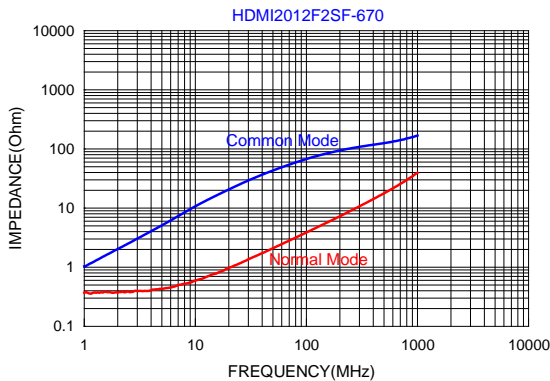

■ TDR Test and Eye Diagram Graphic Test

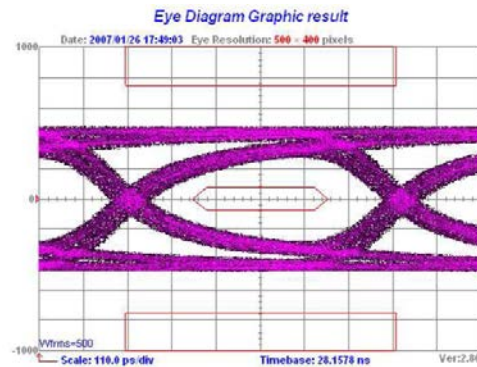
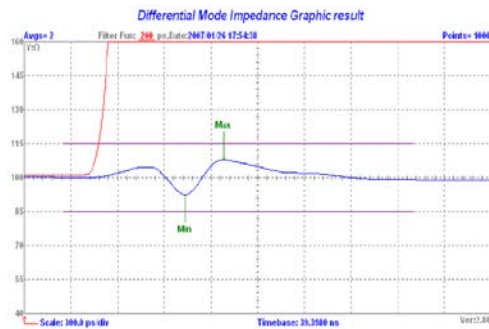

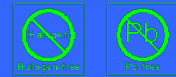

■ Dimensions

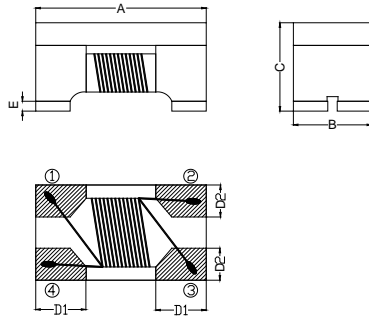

Chip Size	
A	1.20±0.20
B	1.00±0.20
C	0.90 max.
D1	0.35±0.10
D2	0.35±0.10
E	0.03 min.

Units: mm

■ Specifications

Part Number	Common mode Impedance (Ω)	Test Frequency (MHz)	DC Resistance (Ω) max.	Rated Current (mA)	Rated Volt. (Vdc)	Withstand Volt. (Vdc)	IR (Ω) min.
HSF1210F2SF-500T02	50±25%	100	0.30	250	50	125	10M
HSF1210F2SF-670T02	67±25%	100	0.30	250	50	125	10M
HSF1210F2SF-900T02	90±25%	100	0.40	200	50	125	10M

■ Impedance-Frequency Characteristics (Typical)

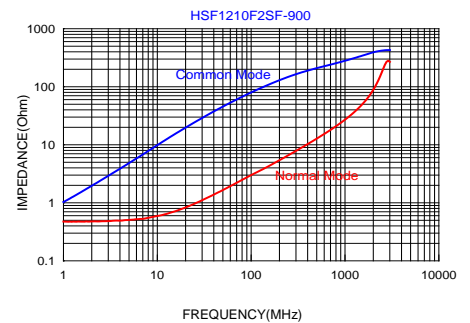
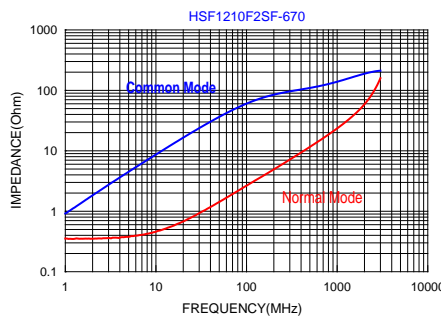
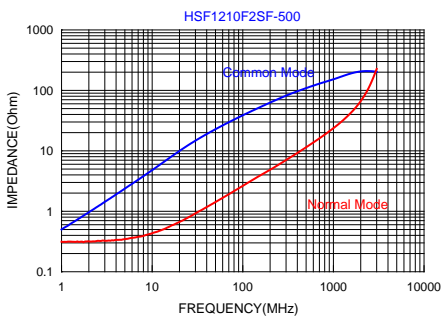

■ Insertion Loss Test (Typical)

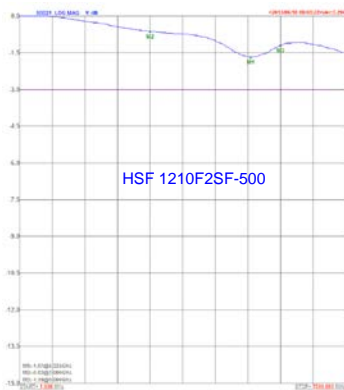



■ Dimensions

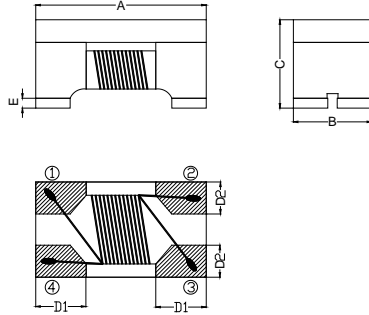

Chip Size	
A	2.00±0.20
B	1.20±0.20
C	1.20±0.20
D1	0.50±0.10
D2	0.50±0.10
E	0.15±0.10

Units: mm

■ Specifications

Part Number	Common mode Impedance (Ω)	Test Frequency (MHz)	DC Resistance (Ω) max.	Rated Current (mA)	Rated Volt. (Vdc)	Withstand Volt. (Vdc)	IR (Ω) min.
HSF2012F2SF-500T04	50±25%	100	0.25	400	50	125	10M
HSF2012F2SF-670T04	67±25%	100	0.30	400	50	125	10M
HSF2012F2SF-900T04	90±25%	100	0.30	400	50	125	10M

■ Impedance-Frequency Characteristics (Typical)

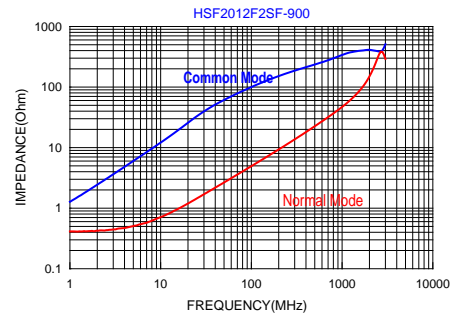
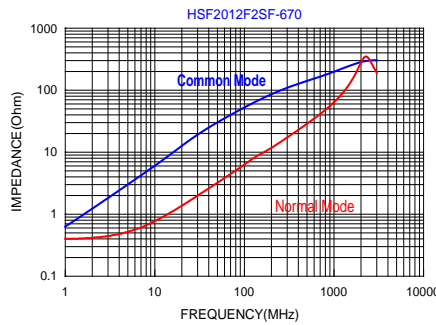
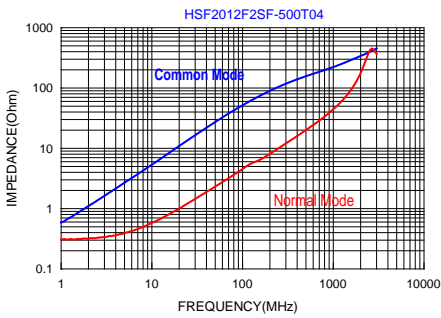

■ Insertion Loss Test (Typical)



LCM 4532 Series (1812 inch)

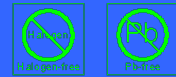

■ Dimensions

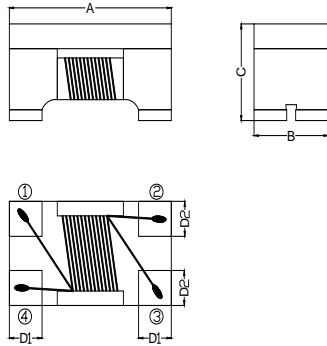

Chip Size	
A	4.50±0.20
B	3.20±0.20
C	2.80±0.20
D1	1.00±0.10
D2	1.20±0.10

Units: mm

■ Specifications

Part Number	Common mode Impedance (Ω) [10MHz]		Common mode Inductance (μ H)+50/-30% [100kHz]	DC Resistance (Ω) max.	Rated Current (mA) max.	Rated Volt. (Vdc) max.	IR (Ω) min.
	min.	typ.					
LCM4532F2SF-110T03	300 min.	700 typ.	11	0.80	300	50	10M
LCM4532F2SF-220T02	500 min.	1000 typ.	22	2.65	200	50	10M
LCM4532F2SF-510T02	1000min.	2000typ.	51	3.50	200	50	10M
LCM4532F2SF-101T02	2000min.	5000typ.	100	8.90	200	50	10M

■ Impedance-Frequency Characteristics (Typical)

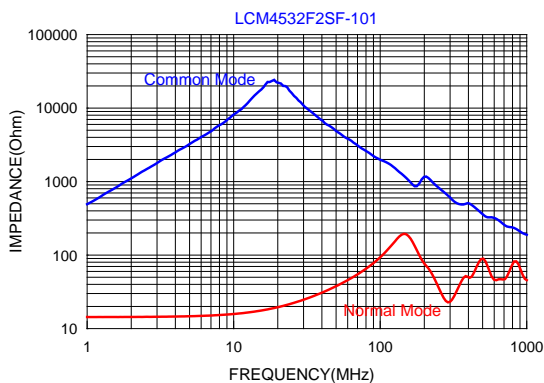
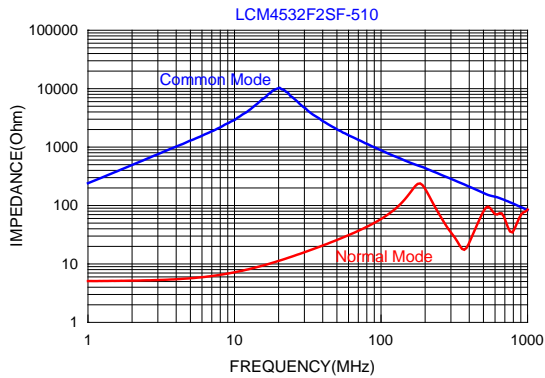
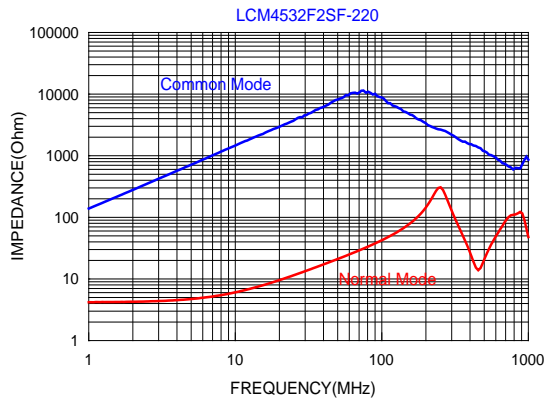
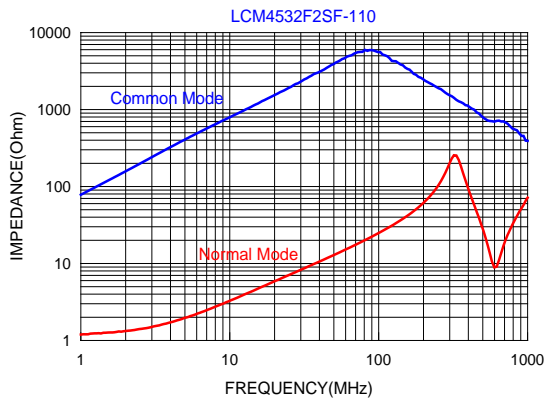

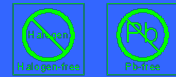

■ Dimensions

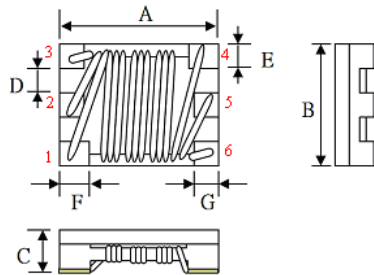

Chip Size	
A	2.50±0.20
B	2.00±0.20
C	1.30 max.
D	0.20±0.10
E	0.55±0.10
F	0.45±0.10
G	0.55±0.10

Units: mm

■ Specifications

Part Number	Common mode Impedance (Ω)	Test Frequency (MHz)	DC Resistance (Ω) max.	Rated Current (mA)max.	Rated Volt.(Vdc) max.	Withstand Volt.(Vdc) max.	IR (Ω) min.
TCM252013F3SFK-670T05	67±25%	100	0.2	500	50	125	10M

■ Impedance-Frequency Characteristics (Typical)

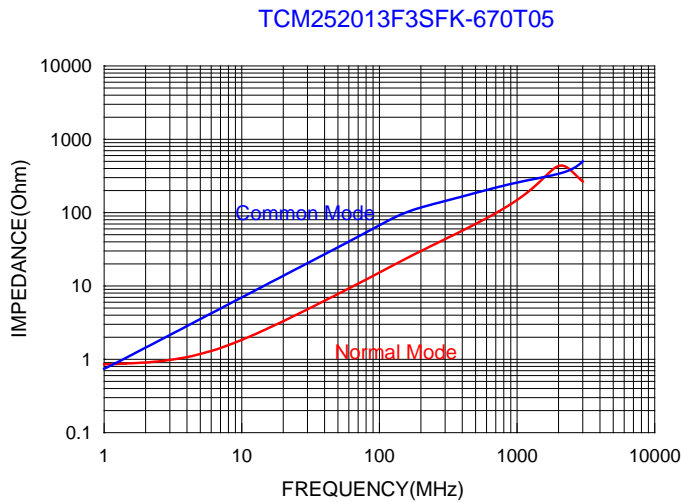

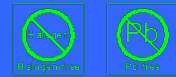

■ Dimensions

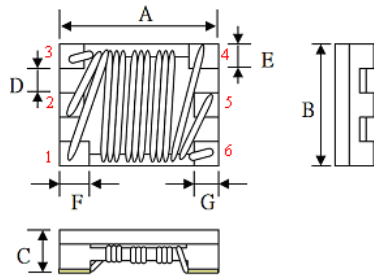

Chip Size	
A	3.20±0.20
B	2.50±0.20
C	1.30 max.
D	0.29±0.10
E	0.64±0.10
F	0.60±0.10
G	0.50±0.10

Units: mm

■ Specifications

Part Number	Common mode Impedance (Ω)	Test Frequency (MHz)	DC Resistance (Ω) max.	Rated Current (mA)max.	Rated Volt.(Vdc) max.	Withstand Volt. (Vdc) max.	IR (Ω) min.
TCM322512F3SFK-161T02	160±25%	100	0.21	200	50	125	10M
TCM322512F3SFK-501T05	500±25%	100	0.43	500	50	125	10M

■ Impedance-Frequency Characteristics (Typical)

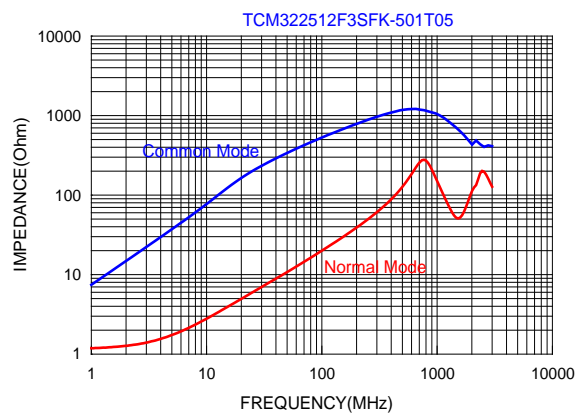
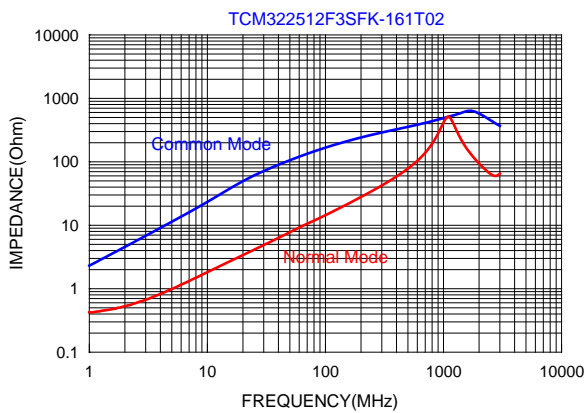

ACM 3225 Series (1210 inch)

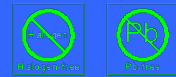

■ Dimensions

Dimensions	
A	3.20±0.20
B	2.50±0.20
C	2.50 MAX
D1	0.70±0.10
D2	0.90±0.10
D3	0.60±0.10

Units: mm

■ Specifications

Part Number	Inductance (μ H)+50/-30% [100kHz/0.1V]	DC Resistance (Ω) max.	Rated Current (mA) max.	Rated voltage (Vdc) max.	IR (M Ω) min.
ACM3225F2WV-101T01	100	1.5	150	80	10

■ Impedance-Frequency Characteristics (Typical)

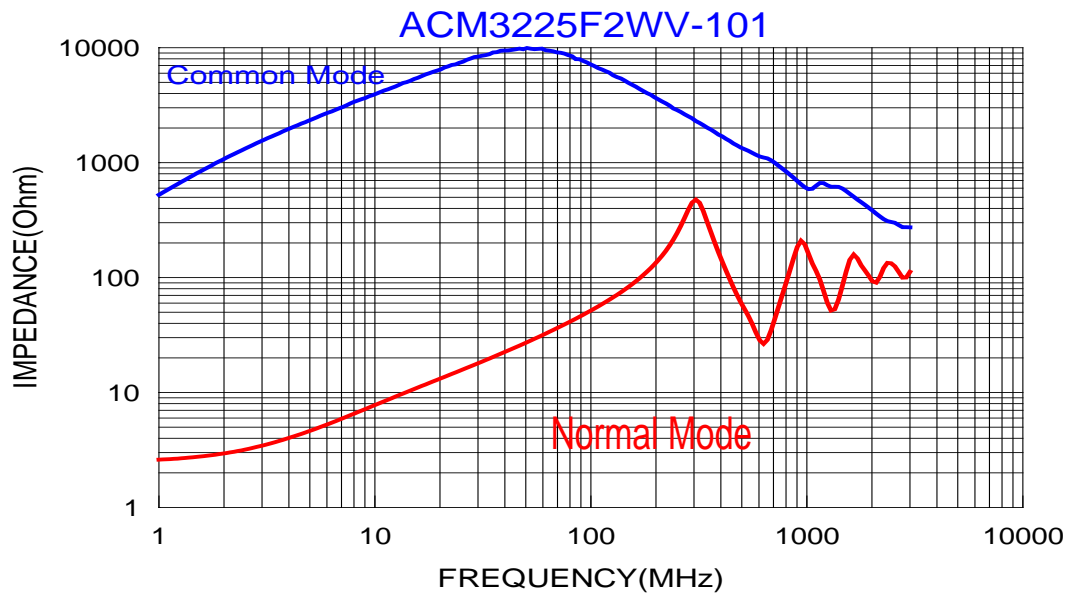

ACM 4532 Series (1812 inch)

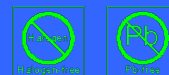

■ Dimensions

Dimensions	
A	4.50±0.20
B	3.20±0.20
C	2.80±0.15
D1	1.00±0.30
D2	0.90±0.30
D3	0.72±0.25

Units: mm

■ Specifications

Part Number	Common mode Impedance (Ω)[10MHz]		Inductance (μH)+50/-30% [100kHz]	DC Resistance (Ω) max.	Rated Current (mA)	Rated Volt. (Vdc)	IR (MΩ) min.
ACM4532F2NV-110T02	300 min.	600 typ.	11	0.6	250	50	10
ACM4532F2NV-220T02	500 min.	1200 typ.	22	1.0	200	50	10
ACM4532F2NV-510T02	1000 min.	2800 typ.	51	1.0	200	50	10
ACM4532F2NV-101T01	2000 min.	5800 typ.	100	2.0	150	50	10
ACM4532F2WV-201T01	-	-	200 (+60/-20uH)	4.5	100	50	10M

■ Impedance-Frequency Characteristics (Typical)

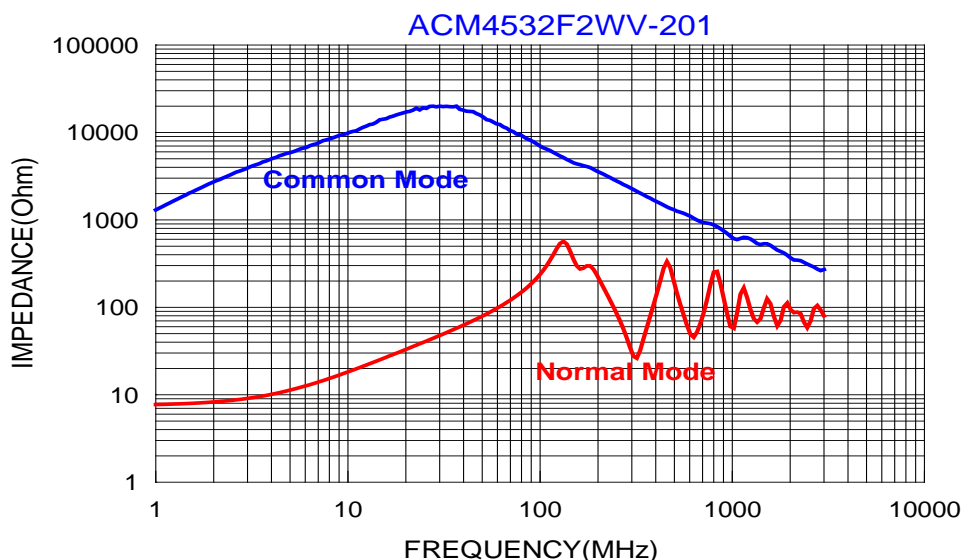

DCM 3216 Series (1206 inch)

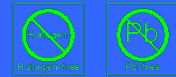

■ Dimensions

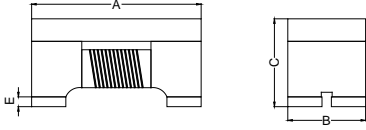
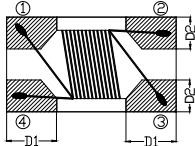
Dimensions	
A	3.40±0.20
B	1.60±0.20
C	2.00±0.20
D1	0.64±0.10
D2	0.66±0.10

Units: mm

■ Specifications

Part Number	Inductance (uH) [100kHz/0.1V] Min.	DC Resistance (Ω)Max.	Rated Current (mA)	Rated Volt. (Vdc)	Withstand Volt. (Vdc) max.	IR (Ω) min.
DCM321620F2SF-600T02	60	1.7	200	50	125	10M

■ Impedance-Frequency Characteristics (Typical)

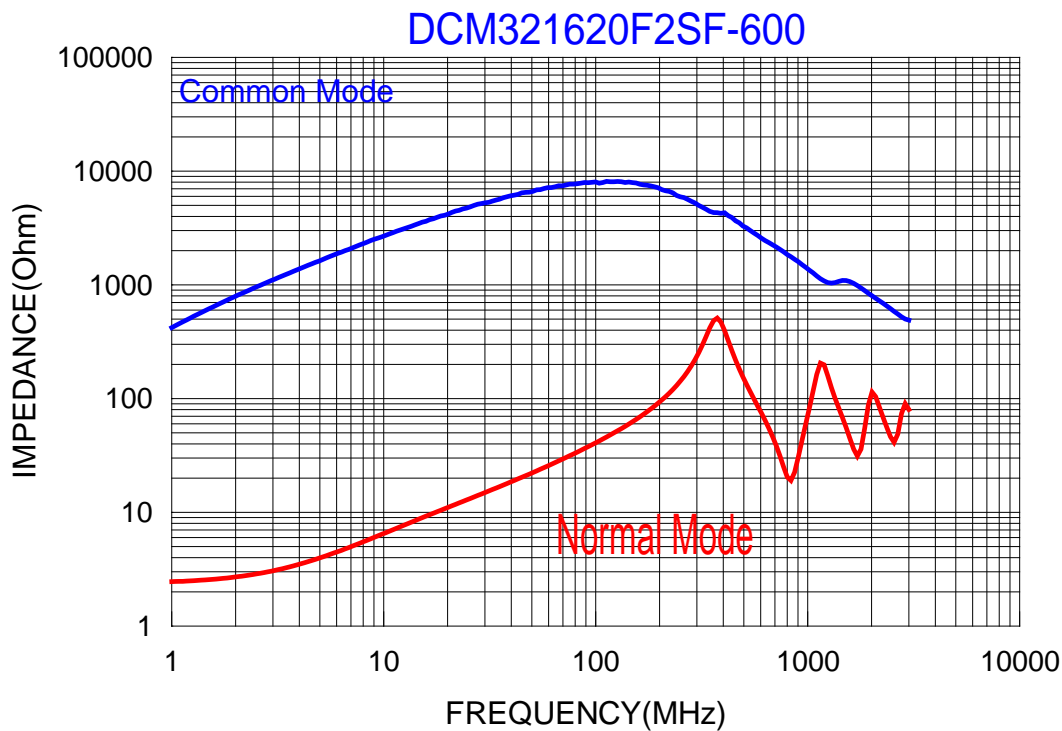

DCM 3532 Series (1412 inch)

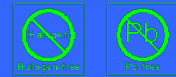

■ Dimensions

Dimensions	
A	3.50±0.20
B	3.20±0.20
C	2.30±0.20
D1	0.63±0.10
D2	1.18±0.10

Units: mm

■ Specifications

Part Number	Inductance (uH) [100kHz/0.1V] Min.	DC Resistance (Ω)Max.	Rated Current (mA)	Rated Volt. (Vdc)	Withstand Volt. (Vdc) max.	IR (Ω) min.
DCM3532F2SF-750T03	75	0.8	300	50	125	10M

■ Impedance-Frequency Characteristics (Typical)

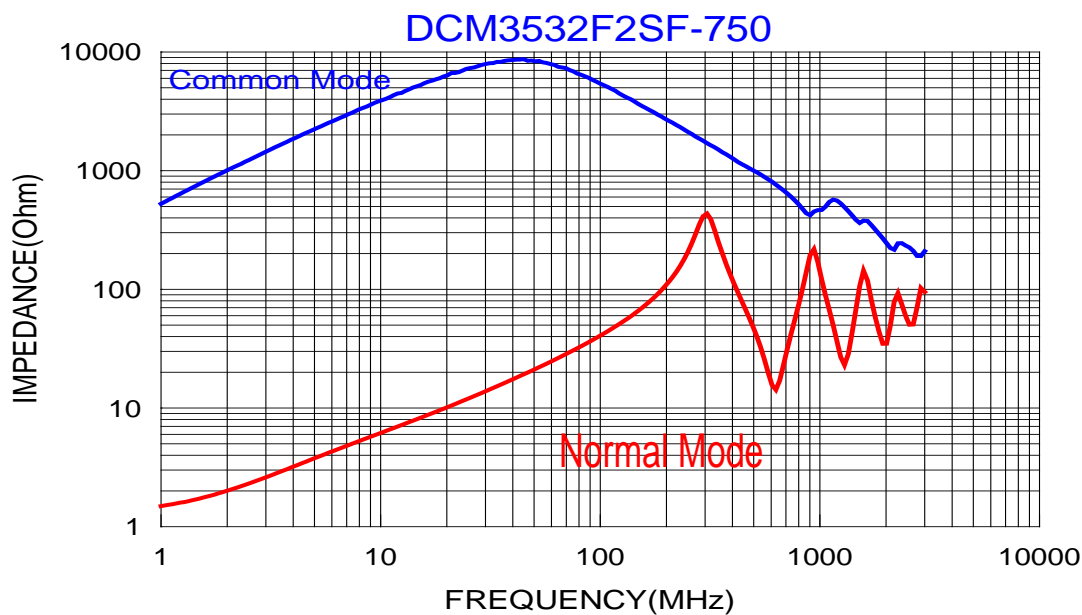



■ Dimensions

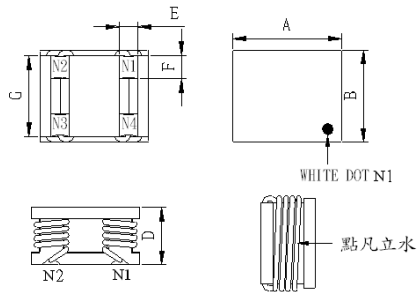

Dimensions	unit: mm
A	7.50±0.50
B	6.00±0.50
D	3.00±0.50
E	1.50 REF.
F	1.50 REF.
G	5.50 REF.

■ Specifications

TAI-TECH Part Number	Impedance (Ω)	Test Frequency (MHz)	Inductance (μ H)	Test Frequency (Hz)	Rated Current (A) max.	DC Resistance (Ω) max. (1 line)
SCM750603-301-4A0	300 ref	100M	4.95 ref.	1V/1K	4.0	0.025
SCM750603-651-5A0	650 min.	100M	10.0 ref.	1V/1K	5.0	0.045
SCM750603-901-2A0	900 ref	100M	22.0 ref.	1V/1K	2.0	0.045

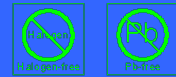

■ Dimensions

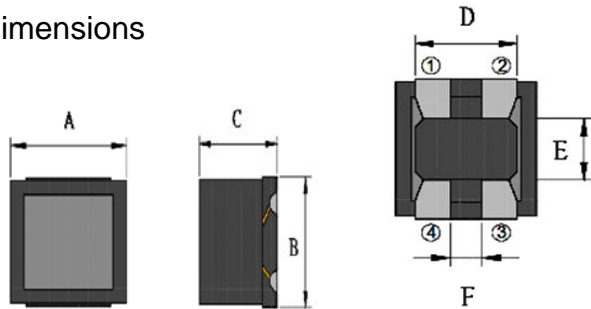

Dimensions	unit: mm
A	4.80±0.30
B	5.00±0.30
C	2.50 MAX
D	3.50 TYP.
E	2.20 TYP.
F	1.10 TYP.

■ Specifications

TAI-TECH Part Number	Common mode Impedance (Ω)	Test Frequency (MHz)	DC Resistance (Ω)±40%	Rated Current (mA) max.	Rated Volt. (Vdc) max.	IR (MΩ) min.
WCM5025F2SF-251T50	250(typ.)	100	0.014	5000	50	10
WCM5025F2SF-501T40	500(typ.)	100	0.019	4000	50	10
WCM5025F2SF-102T20	1000(typ.)	100	0.024	2000	50	10
WCM5025F2SF-152T15	1500(typ.)	100	0.040	1500	50	10

■ Impedance-Frequency Characteristics (Typical)

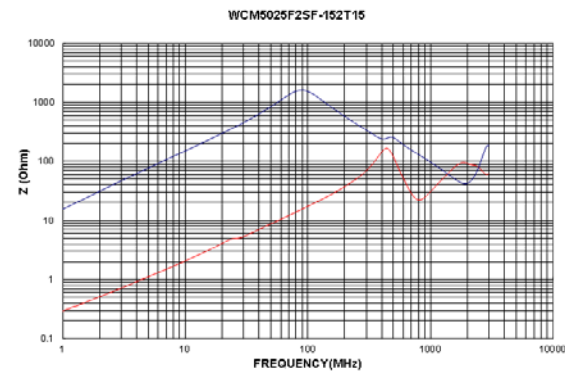
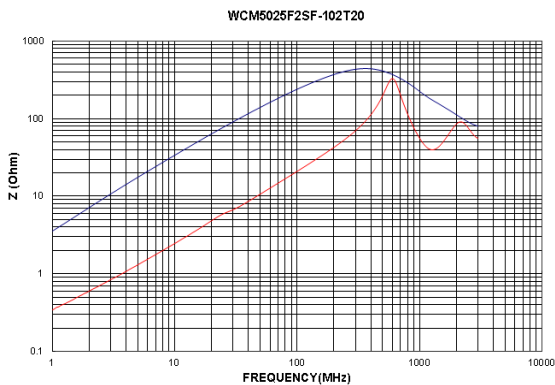
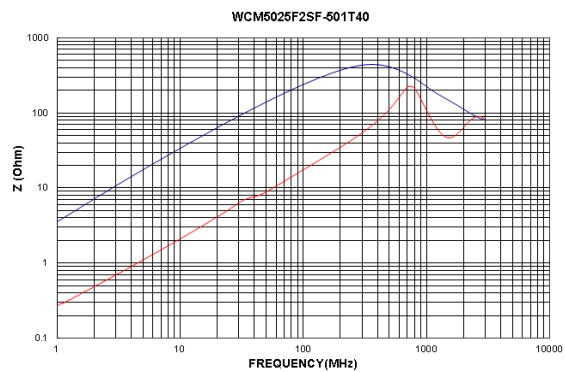
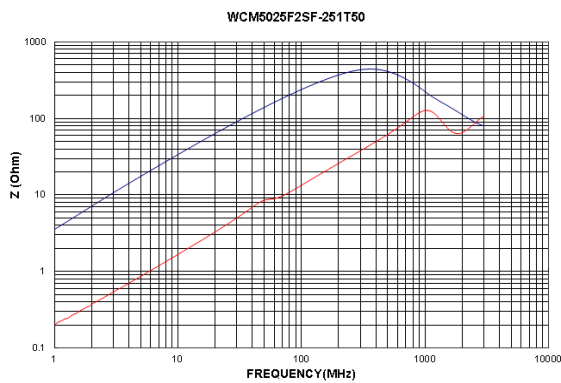

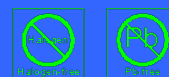

■ Dimensions

Dimensions	unit: mm
A	7.00±0.50
B	6.00±0.50
C	3.80 MAX
D	3.50 TYP.
E	1.50±0.50
F	1.50±0.50
G	1.70±0.50

■ Specifications

TAI-TECH Part Number	Impedance (Ω)	Test Frequency (MHz)	DC Resistance (mΩ) max. (1 line)	Rated Current (A) max.	Rated Volt. (Vdc) max.	Insulation Resistance (MΩ) min.
WCM7060-400-S-M	40 min / 70 typ.	100	5	15	125	10
WCM7060-101-S-M	100 min / 140 typ.	100	10	9	125	10
WCM7060-301-S-M	225 min / 300 typ.	100	10	5	125	10
WCM7060-701-S-M	500 min / 700 typ.	100	15	4	125	10
WCM7060-102-S-M	800 min / 1020 typ.	100	17	3	125	10
WCM7060-132-S-M	910 min / 1300 typ.	100	21	2.5	125	10

■ Test Method

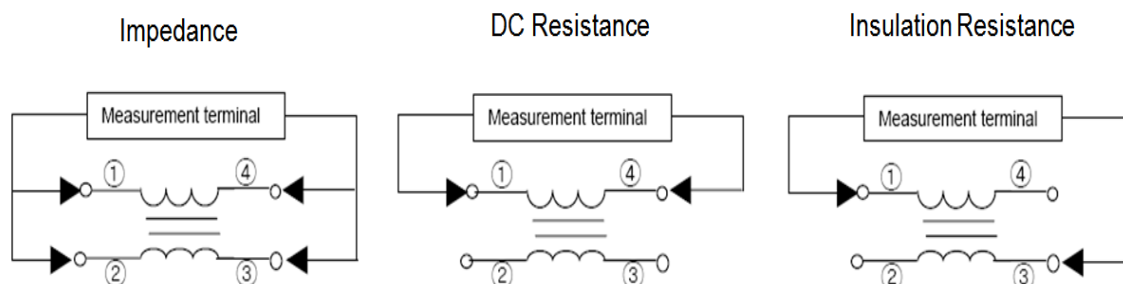

WCM9070 Series (3528 inch)

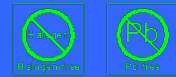

■ Dimensions

Dimensions	unit: mm
A	9.00±0.50
B	7.00±0.50
C	4.80 MAX
D	5.70 TYP.
E	1.50±0.20
F	2.00±0.20
G	1.70±0.20

■ Specifications

TAI-TECH Part Number	Impedance (Ω)	Test Frequency (MHz)	DC Resistance (Ω) max. (1 line)	Rated Current (A) max.	Rated Volt. (Vdc) max.	Insulation Resistance (MΩ) min.
WCM9070-301T60-M	225 min / 300 typ.	100	6m	6	80	10
WCM9070-501T60-M	450 min / 600 typ.	100	8m	6	80	10
WCM9070-701T50-M	500 min / 700 typ.	100	10m	5	80	10
WCM9070-102T40-M	750 min / 1000 typ.	100	13m	4	80	10
WCM9070-272T20-M	2000 min / 2700 typ.	100	86m	2	80	10

■ Test Method

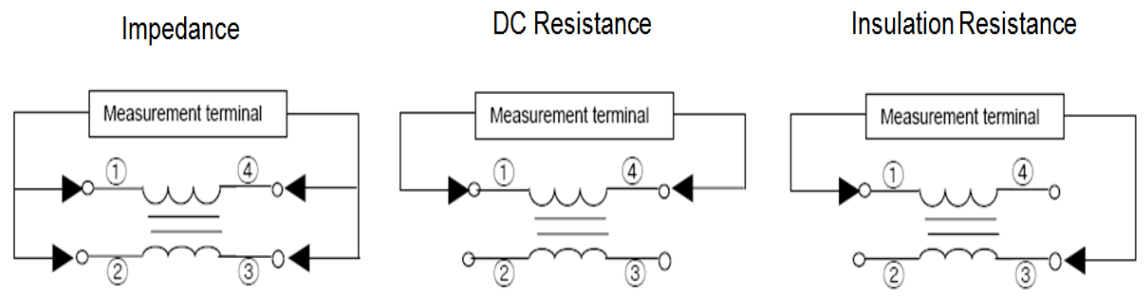



■ Dimensions

Dimensions	unit: mm
A	12.00±0.50
B	10.80±0.50
C	6.40 MAX
D	7.00 TYP.
E	2.70±0.20
F	2.50±0.20
G	2.50±0.20

■ Specifications

TAI-TECH Part Number	Impedance (Ω)	Test Frequency (MHz)	DC Resistance (Ω) max. (1 line)	Rated Current (A) max.	Rated Volt. (Vdc) max.	Insulation Resistance (M Ω) min.
WCM1211F-102T60-M	750min / 1000 typ.	100	14m	6.0	125	10
WCM1211F-701T80-M	500min / 700 typ.	100	6m	8	50	10

■ Test Method

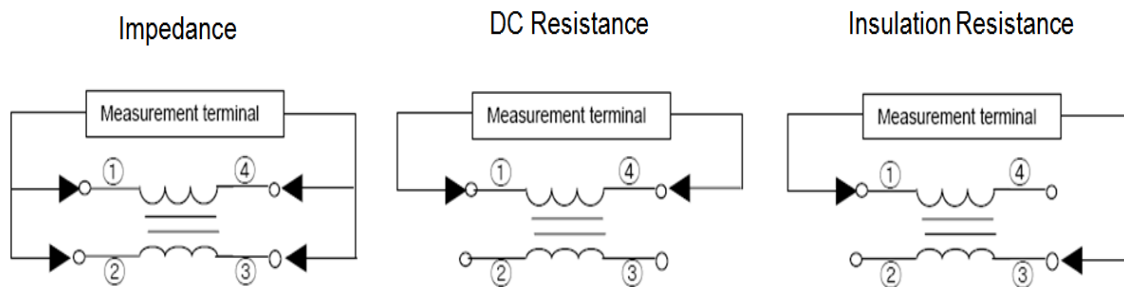

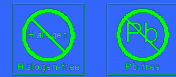

■ Dimensions

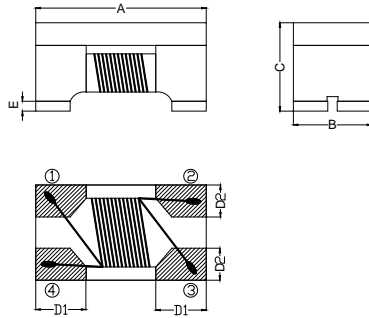

Chip Size	
A	2.00±0.20
B	1.20±0.20
C	1.20±0.20
D1	0.50±0.10
D2	0.51±0.10
E	0.15±0.10

Units: mm

■ Specifications

Part Number	UB/B Impedance (Ω)	Test Frequency (GHz)	DC Resistance (Ω) max.	Rated Power (dBm) max.	Rated Volt. (DCV) max.	With stand Volt. (DCV) max.	IR (Ω) min.	Insertion Loss (dB) 1 to 1.5 GHz	CMRR (dB) 1 to 1.5 GHz
BCM2012F2SF-75011-121	75/75	1-1.5	0.59	27	20	50	10M	1.4 max.	20 min.

■ Characteristics (Typical)

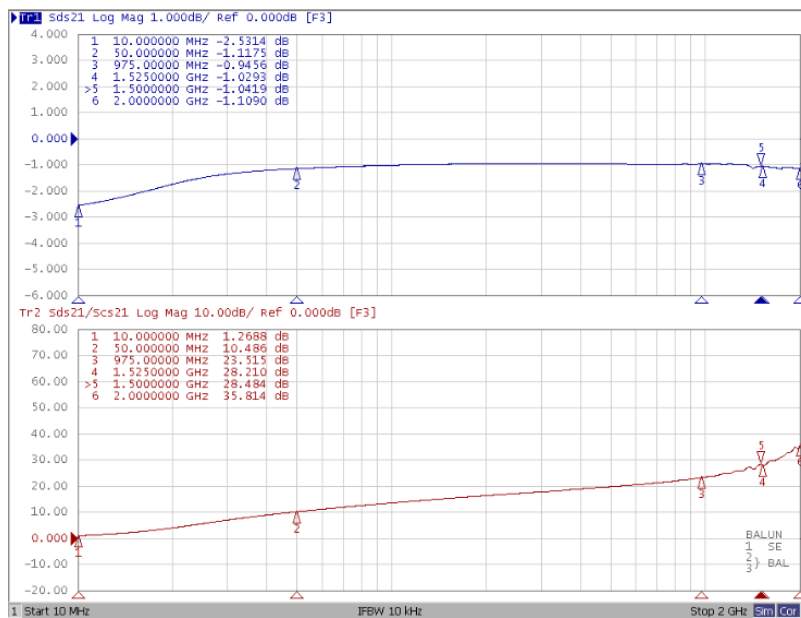



Chip Coils / Inductors

■ Multilayer Ferrite Chip Inductors

FCI Series 83

■ Wire wound Ferrite Chip Inductors

SWF-LF Series 87

SWF-C Series 89

WIH Series 93

■ High Frequency Multilayer Chip Inductors

HCI Series 94

■ High Frequency Wirewound Chip Inductors

SWI-PF Series 103

SWI Series 105

■ Hearing Aid (HAC) Inductors

PAS Series 113



■ Dimensions

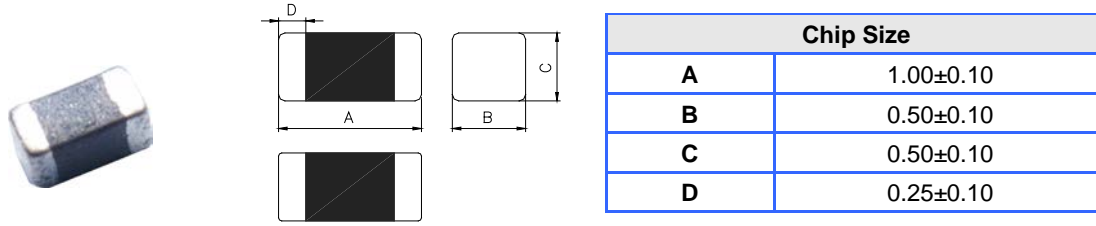

Units: mm

■ Specifications

Part Number	Inductance(uH)		Q		Rated Current (mA) max.	DCR (Ω) max.	SRF (MHz) min.
	Tolerance	Test Frequency (Hz)	min.	Test Frequency (MHz)			
FCI1005F-R22K	0.22±10%	60mV / 25M	10	25	25	1.20	110
FCI1005F-1R0K	1.0±10%	60mV / 10M	20	10	15	0.90	40
FCI1005F-1R8K	1.8±10%	60mV / 10M	20	10	15	1.45	30
FCI1005F-2R2K	2.2±10%	60mV / 10M	20	10	10	1.70	28

■ Q vs Frequency, DC Bias Characteristics (Typical)

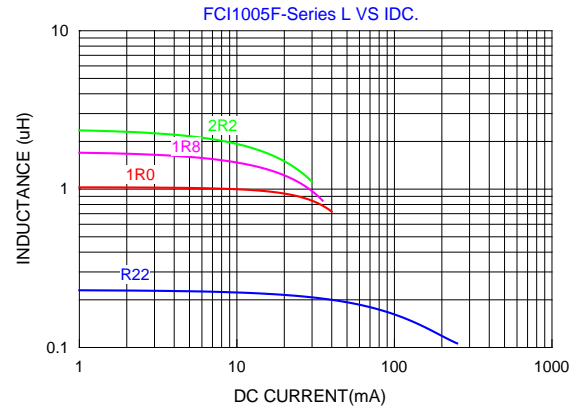
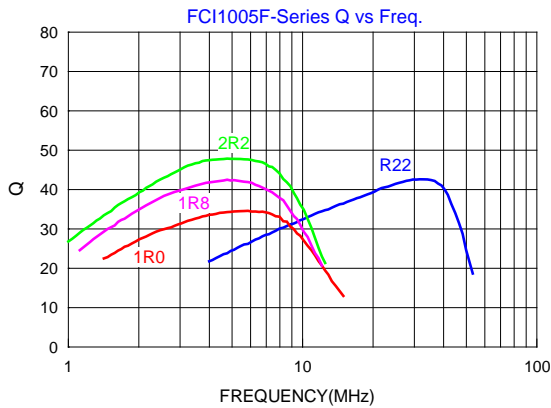



■ Dimensions

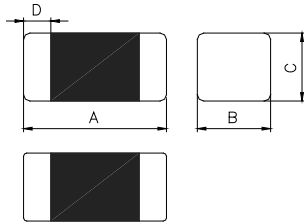

Chip Size		
A	1.60±0.15	1.80±0.15
B	0.80±0.15	
C	0.80±0.15	
D	0.30±0.20	

Units: mm

■ Specifications

Part Number	Thickness A Size(mm)	Inductance(uH)		Q		Rated Current (mA) max.	DCR (Ω) max.	SRF (MHz) min.
		Tolerance	Test Frequency (Hz)	min.	Test Frequency (MHz)			
FCI1608F-47N□	1.60±0.15	0.047	60mV / 50M	10	50	50	0.30	260
FCI1608F-68N□	1.60±0.15	0.068	60mV / 50M	10	50	50	0.30	250
FCI1608F-82N□	1.60±0.15	0.082	60mV / 50M	10	50	50	0.30	245
FCI1608F-R10□	1.60±0.15	0.10	60mV / 25M	15	25	50	0.50	240
FCI1608F-R12□	1.60±0.15	0.12	60mV / 25M	15	25	50	0.50	205
FCI1608F-R15□	1.60±0.15	0.15	60mV / 25M	15	25	50	0.60	180
FCI1608F-R18□	1.60±0.15	0.18	60mV / 25M	15	25	50	0.60	165
FCI1608F-R22□	1.60±0.15	0.22	60mV / 25M	15	25	50	0.80	150
FCI1608F-R27□	1.60±0.15	0.27	60mV / 25M	15	25	50	0.80	136
FCI1608F-R33□	1.60±0.15	0.33	60mV / 25M	15	25	35	0.85	125
FCI1608F-R39□	1.60±0.15	0.39	60mV / 25M	15	25	35	1.00	110
FCI1608F-R47□	1.60±0.15	0.47	60mV / 25M	15	25	35	1.35	105
FCI1608F-R56□	1.60±0.15	0.56	60mV / 25M	15	25	35	1.55	95
FCI1608F-R68□	1.60±0.15	0.68	60mV / 25M	15	25	35	1.70	80
FCI1608F-R82□	1.60±0.15	0.82	60mV / 25M	15	25	35	2.10	75
FCI1608F-1R0□	1.60±0.15	1.0	60mV / 10M	30	10	25	0.60	70
FCI1608F-1R5□	1.60±0.15	1.5	60mV / 10M	30	10	25	0.80	55
FCI1608F-1R8□	1.60±0.15	1.8	60mV / 10M	30	10	25	0.95	50
FCI1608F-2R2□	1.60±0.15	2.2	60mV / 10M	30	10	15	1.15	45
FCI1608F-3R3□	1.60±0.15	3.3	60mV / 10M	30	10	15	1.55	38
FCI1608F-4R7□	1.60±0.15	4.7	60mV / 10M	30	10	15	2.10	33
FCI1608TF-100□	1.80±0.15	10.0	60mV / 2M	30	2	15	2.55	17

□: K=±10%, L=±15%, M=±20%

■ Q vs Frequency, DC Bias Characteristics (Typical)

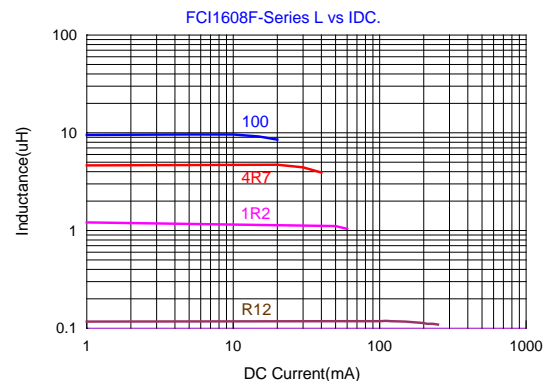
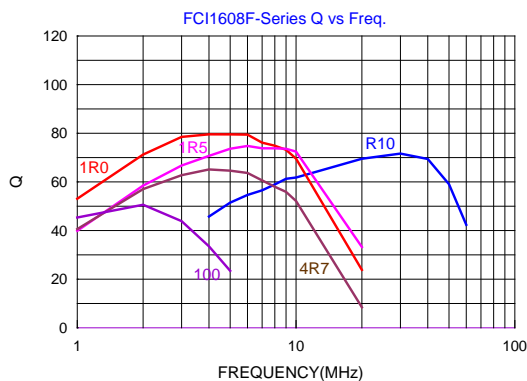



■ Dimensions

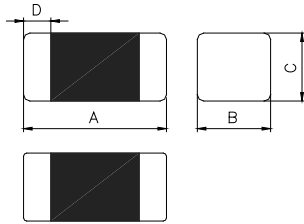

Chip Size	
A	2.00±0.20
B	1.25±0.20
C	0.85±0.20 1.25±0.20
D	0.50±0.30

Units: mm

■ Specifications

Part Number	Thickness C Size(mm)	Inductance(μH)		Q		Rated Current (mA) max.	DCR (Ω) max.	SRF (MHz) min.
		Tolerance	Test Frequency (Hz)	min.	Test Frequency (MHz)			
FCI2012F-47N□	0.85±0.20	0.047	60mV / 50M	15	50	300	0.20	320
FCI2012F-68N□	0.85±0.20	0.068	60mV / 50M	15	50	300	0.20	280
FCI2012F-82N□	0.85±0.20	0.082	60mV / 50M	15	50	300	0.20	255
FCI2012F-R10□	0.85±0.20	0.10	60mV / 25M	20	25	250	0.30	235
FCI2012F-R12□	0.85±0.20	0.12	60mV / 25M	20	25	250	0.30	220
FCI2012F-R15□	0.85±0.20	0.15	60mV / 25M	20	25	250	0.40	200
FCI2012F-R18□	0.85±0.20	0.18	60mV / 25M	20	25	250	0.40	185
FCI2012F-R22□	0.85±0.20	0.22	60mV / 25M	20	25	250	0.50	170
FCI2012F-R27□	0.85±0.20	0.27	60mV / 25M	20	25	250	0.50	150
FCI2012F-R33□	0.85±0.20	0.33	60mV / 25M	20	25	250	0.55	145
FCI2012F-R39□	0.85±0.20	0.39	60mV / 25M	25	25	200	0.65	135
FCI2012F-R47□	1.25±0.20	0.47	60mV / 25M	25	25	200	0.65	125
FCI2012F-R56□	1.25±0.20	0.56	60mV / 25M	25	25	150	0.75	115
FCI2012F-R68□	1.25±0.20	0.68	60mV / 25M	25	25	150	0.80	105
FCI2012F-1R0□	0.85±0.20	1.0	60mV / 10M	45	10	50	0.40	75
FCI2012F-1R5□	0.85±0.20	1.5	60mV / 10M	45	10	50	0.50	60
FCI2012F-1R8□	0.85±0.20	1.8	60mV / 10M	45	10	50	0.60	55
FCI2012F-2R2□	0.85±0.20	2.2	60mV / 10M	45	10	30	0.65	50
FCI2012F-2R7□	1.25±0.20	2.7	60mV / 10M	45	10	30	0.75	45
FCI2012F-3R3□	1.25±0.20	3.3	60mV / 10M	45	10	30	0.80	41
FCI2012F-4R7□	1.25±0.20	4.7	60mV / 10M	45	10	30	1.00	35
FCI2012F-100□	1.25±0.20	10.0	60mV / 2M	45	2	15	1.15	24

□: K=±10%, L=±15%, M=±20%

■ Q vs Frequency, DC Bias Characteristics (Typical)

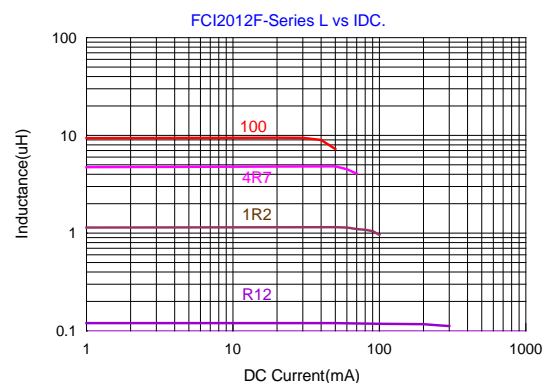
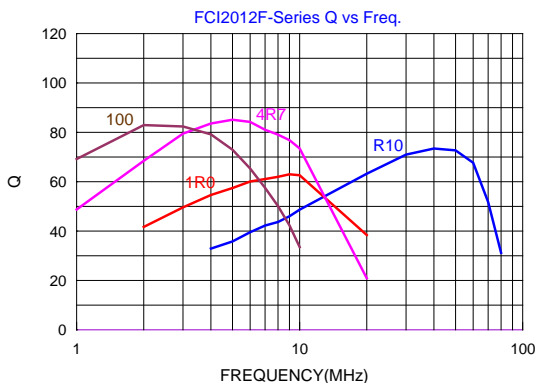

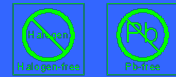

■ Dimensions

Chip Size	
A	3.20±0.20
B	1.60±0.20
C	1.10±0.30
D	0.50±0.30

Units: mm

■ Specifications

Part Number	Inductance(μH)		Q		Rated Current (mA) max.	DCR (Ω) max.	SRF (MHz) min.
	Tolerance	Test Frequency (Hz)	min.	Test Frequency (MHz)			
FCI3216F-47N□	0.047	60mV / 50M	20	50	300	0.15	320
FCI3216F-68N□	0.068	60mV / 50M	20	50	300	0.25	280
FCI3216F-R10□	0.10	60mV / 25M	20	25	250	0.25	235
FCI3216F-R12□	0.12	60mV / 25M	20	25	250	0.30	220
FCI3216F-R15□	0.15	60mV / 25M	20	25	250	0.30	200
FCI3216F-R18□	0.18	60mV / 25M	20	25	250	0.40	185
FCI3216F-R22□	0.22	60mV / 25M	20	25	250	0.40	170
FCI3216F-R27□	0.27	60mV / 25M	20	25	250	0.50	150
FCI3216F-R33□	0.33	60mV / 25M	20	25	250	0.50	145
FCI3216F-R39□	0.39	60mV / 25M	25	25	250	0.60	135
FCI3216F-R47□	0.47	60mV / 25M	25	25	200	0.60	125
FCI3216F-R56□	0.56	60mV / 25M	25	25	200	0.70	115
FCI3216F-R68□	0.68	60mV / 25M	25	25	150	0.80	105
FCI3216F-R82□	0.82	60mV / 25M	25	25	150	0.90	100
FCI3216F-1R0□	1.0	60mV / 10M	45	10	100	0.40	75
FCI3216F-1R2□	1.2	60mV / 10M	45	10	100	0.50	65
FCI3216F-1R5□	1.5	60mV / 10M	45	10	50	0.50	60
FCI3216F-2R2□	2.2	60mV / 10M	45	10	50	0.60	50
FCI3216F-3R3□	3.3	60mV / 10M	45	10	50	0.70	41
FCI3216F-4R7□	4.7	60mV / 10M	45	10	50	0.90	35
FCI3216F-100□	10.0	60mV / 2M	50	2	25	1.00	24

□: K=±10%, L=±15%, M=±20%

■ Q vs Frequency, DC Bias Characteristics (Typical)

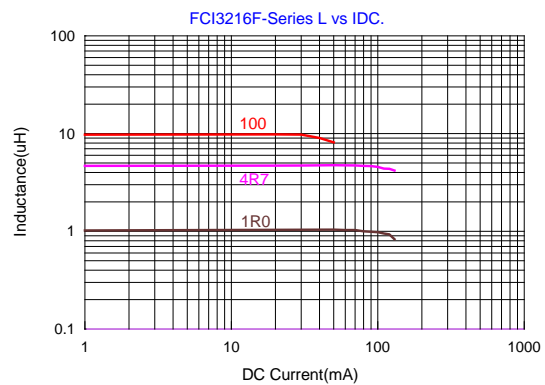
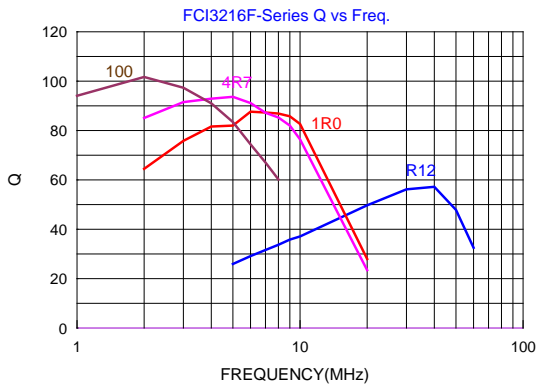



■ Dimensions

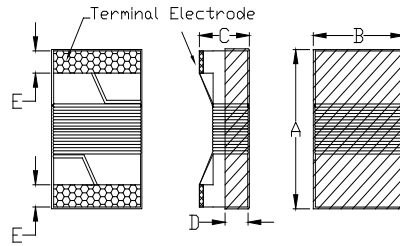

Dimensions		unit: mm
A		1.65±0.15
B		1.15±0.15
C		1.05±0.15
D		0.38 ref.
E		0.35±0.10

■ Specifications

TAI-TECH Part Number	Inductance (uH)	Tolerance	Test Frequency (Hz)	Q Typ	Test Frequency (MHz)	SRF (MHz) typ.	DCR (Ω) max.	IDC (mA) max.
SWF1608LF-47N	0.047	K	0.5V/7.9M	17	7.9	1700	0.075	1500
SWF1608LF-72N	0.072	K	0.5V/7.9M	17	7.9	1700	0.12	1500
SWF1608LF-R10	0.1	K	0.5V/7.9M	17	7.9	1500	0.12	1500
SWF1608LF-R15	0.15	K	0.5V/7.9M	17	7.9	1350	0.15	1450
SWF1608LF-R18	0.18	K	0.5V/7.9M	17	7.9	1150	0.15	1400
SWF1608LF-R33	0.33	K	0.5V/7.9M	17	7.9	850	0.46	900
SWF1608LF-R39	0.39	K	0.5V/7.9M	17	7.9	810	0.51	1100
SWF1608LF-R47	0.47	K	0.5V/7.9M	17	7.9	720	0.62	1050
SWF1608LF-R56	0.56	K	0.5V/7.9M	17	7.9	600	0.44	850
SWF1608LF-R68	0.68	K	0.5V/7.9M	17	7.9	600	0.52	850
SWF1608LF-R82	0.82	K	0.5V/7.9M	17	7.9	480	0.69	750
SWF1608LF-R91	0.91	K	0.5V/7.9M	17	7.9	330	0.76	670
SWF1608LF-1R0	1.00	K	0.5V/7.9M	17	7.9	310	0.81	600
SWF1608LF-1R2	1.2	K	0.5V/7.9M	17	7.9	270	0.87	550
SWF1608LF-1R5	1.5	K	0.5V/7.9M	17	7.9	270	1.06	540
SWF1608LF-1R8	1.8	K	0.5V/7.9M	17	7.9	230	1.1	520
SWF1608LF-2R2	2.2	K	0.5V/7.9M	17	7.9	130	1.2	500
SWF1608LF-2R7	2.7	K	0.5V/7.9M	17	7.9	105	1.5	480
SWF1608LF-3R3	3.3	K	0.5V/7.9M	17	7.9	84	1.5	440
SWF1608LF-3R9	3.9	K	0.5V/7.9M	17	7.9	80	1.6	430
SWF1608LF-4R7	4.7	J,K	0.5V/7.9M	18	7.9	69	2.1	420
SWF1608LF-5R6	5.6	J,K	0.5V/7.9M	18	7.9	65	2.6	350
SWF1608LF-6R8	6.8	J,K	0.5V/7.9M	19	7.9	55	3.1	330
SWF1608LF-7R8	7.8	J,K	0.5V/7.9M	17	7.9	47	3.5	320
SWF1608LF-8R2	8.2	J,K	0.5V/7.9M	17	7.9	42	3.8	300
SWF1608LF-100	10	J,K	0.5V/7.9M	19	7.9	40	4.8	270



■ Impedance vs Frequency, DC Bias Characteristics (Typical)

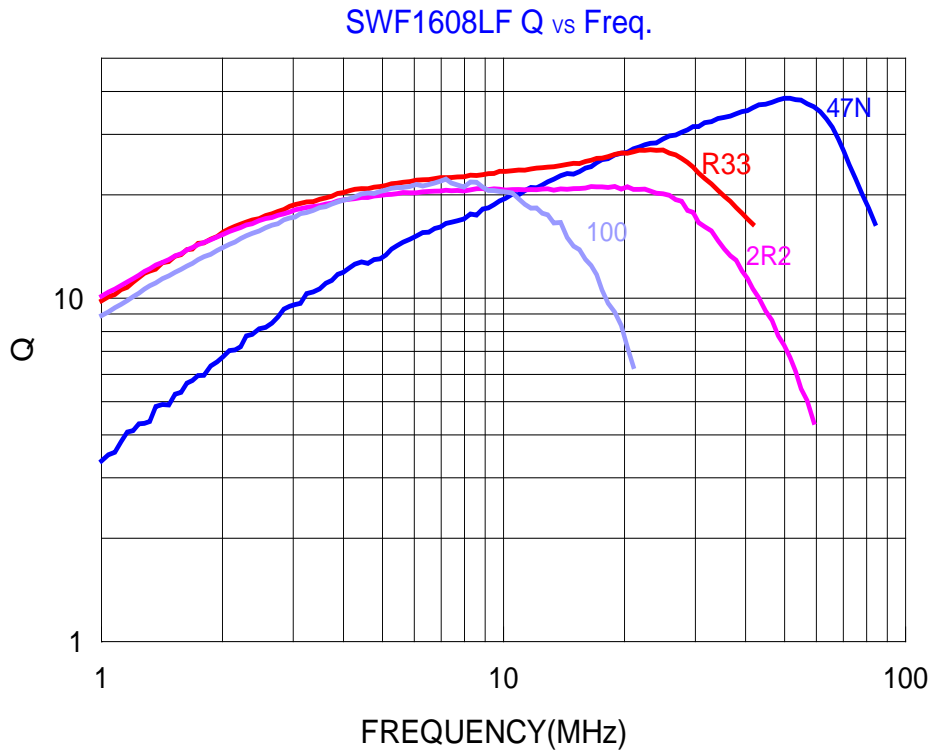
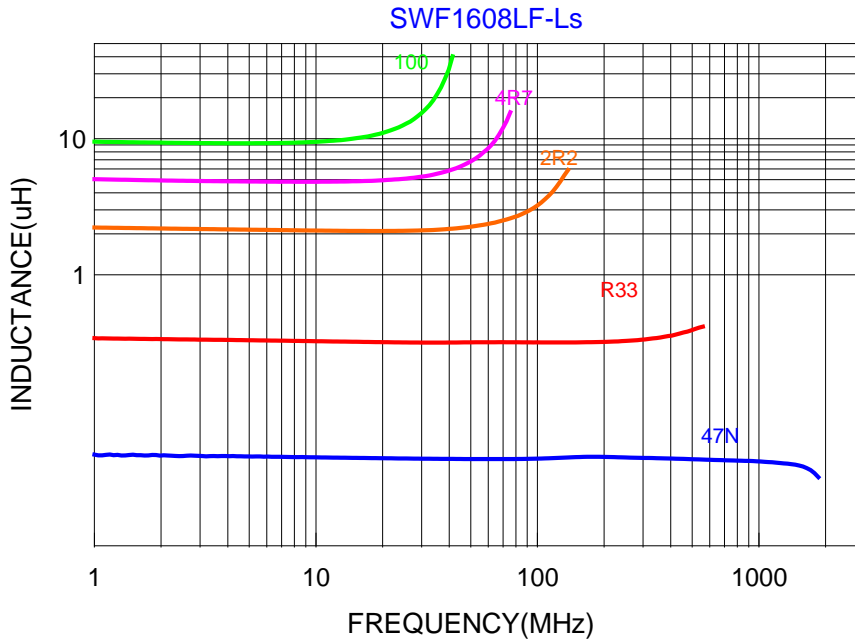

SWF 1608CF Series (0603 inch)

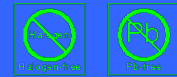

■ Dimensions

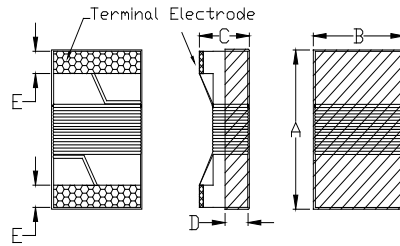
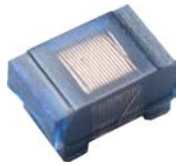

Chip Size	
A	1.80 max.
B	1.20 max.
C	1.20 max.
D	0.38 ref.
E	0.35±0.10

Units: mm

■ Specifications

Part Number	Inductance (uH)	Test Frequency (Hz)	Q min.	Test Frequency (MHz)	SRF (MHz) min.	DC Resistance (Ω) max.	Rated Current (mA) max.
SWF1608CF-47N□	0.047	0.5V/7.96M	10	7.96	1500	0.075	1400
SWF1608CF-R10□	0.10	0.5V/7.96M	10	7.96	1150	0.13	1400
SWF1608CF-R12□	0.12	0.5V/7.96M	10	7.96	1100	0.15	1400
SWF1608CF-R15□	0.15	0.5V/7.96M	10	7.96	1050	0.15	1300
SWF1608CF-R22□	0.22	0.5V/7.96M	10	7.96	800	0.15	950
SWF1608CF-R27□	0.27	0.5V/7.96M	10	7.96	775	0.20	710
SWF1608CF-R33□	0.33	0.5V/7.96M	10	7.96	725	0.35	620
SWF1608CF-R39□	0.39	0.5V/7.96M	10	7.96	620	0.39	600
SWF1608CF-R47□	0.47	0.5V/7.96M	10	7.96	540	0.43	570
SWF1608CF-R56□	0.56	0.5V/7.96M	10	7.96	525	0.47	550
SWF1608CF-R68□	0.68	0.5V/7.96M	10	7.96	460	0.52	470
SWF1608CF-R82□	0.82	0.5V/7.96M	10	7.96	410	0.69	400
SWF1608CF-1R0□	1.0	0.5V/7.96M	10	7.96	190	0.81	400
SWF1608CF-1R2□	1.2	0.5V/7.96M	10	7.96	160	0.87	370
SWF1608CF-1R5□	1.5	0.5V/7.96M	10	7.96	100	0.96	350
SWF1608CF-2R2□	2.2	0.5V/7.96M	10	7.96	68	1.20	320
SWF1608CF-3R3□	3.3	0.5V/7.96M	10	7.96	42	1.50	280
SWF1608CF-4R7□	4.7	0.5V/7.96M	10	7.96	34	2.10	260
SWF1608CF-6R8□	6.8	0.5V/7.96M	10	7.96	31	3.10	200
SWF1608CF-100□	10.0	0.5V/2.52M	10	2.52	25	4.80	180

□ : K=±10% , M=±20%

■ Impedance vs Frequency, DC Bias Characteristics (Typical)

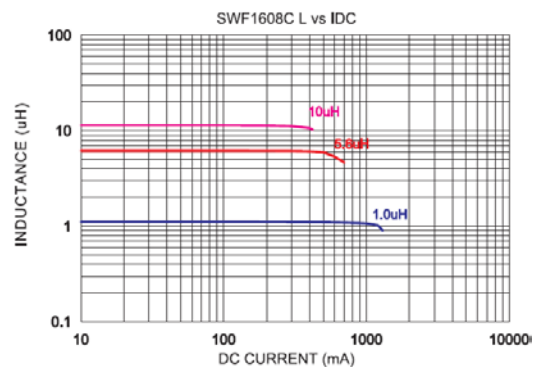
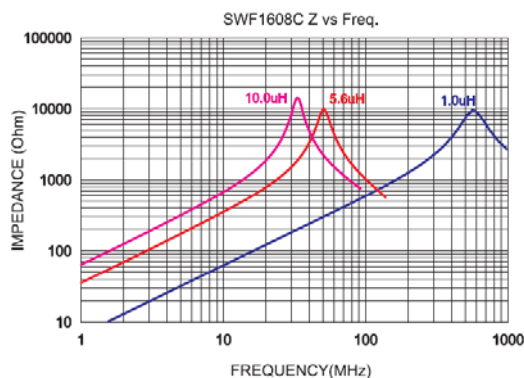

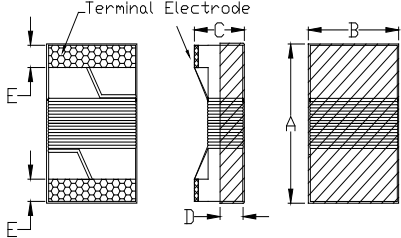

■ Dimensions

Chip Size	
A	2.40 max.
B	1.60 max.
C	1.40 max.
D	0.51 ref.
E	0.44±0.10

Units: mm

■ Specifications

Part Number	Inductance (uH)	Test Frequency (Hz)	Q min.	Test Frequency (MHz)	SRF (MHz) min.	DC Resistance (Ω) max.	Rated Current (mA) max.
SWF2012CF-R47□	0.47	0.5V/7.96M	10	7.96	720	0.20	750
SWF2012CF-R56□	0.56	0.5V/7.96M	10	7.96	665	0.21	730
SWF2012CF-R68□	0.68	0.5V/7.96M	10	7.96	565	0.28	670
SWF2012CF-1R0□	1.00	0.5V/7.96M	10	7.96	525	0.34	615
SWF2012CF-1R2□	1.20	0.5V/7.96M	10	7.96	473	0.39	550
SWF2012CF-1R5□	1.50	0.5V/7.96M	10	7.96	300	0.45	520
SWF2012CF-2R2□	2.20	0.5V/7.96M	10	7.96	215	0.67	420
SWF2012CF-3R3□	3.30	0.5V/7.96M	10	7.96	95	0.81	385
SWF2012CF-3R9□	3.90	0.5V/7.96M	10	7.96	57	0.88	372
SWF2012CF-4R7□	4.70	0.5V/7.96M	10	7.96	51	0.99	345
SWF2012CF-5R6□	5.60	0.5V/7.96M	10	7.96	44	1.06	335
SWF2012CF-6R8□	6.80	0.5V/7.96M	10	7.96	39	1.21	315
SWF2012CF-8R2□	8.20	0.5V/7.96M	10	7.96	33	1.33	295
SWF2012CF-100□	10.0	0.5V/2.52M	10	2.52	30	1.79	260
SWF2012CF-120□	12.0	0.5V/2.52M	10	2.52	27	1.98	250
SWF2012CF-150□	15.0	0.5V/2.52M	10	2.52	22	2.68	215
SWF2012CF-180□	18.0	0.5V/2.52M	10	2.52	20	3.12	195
SWF2012CF-220□	22.0	0.5V/2.52M	10	2.52	18	3.48	180
SWF2012CF-270□	27.0	0.5V/2.52M	10	2.52	16	3.84	170
SWF2012CF-330□	33.0	0.5V/2.52M	10	2.52	15	4.34	145

□ : K=±10% , M=±20%

■ Impedance vs Frequency, DC Bias Characteristics (Typical)

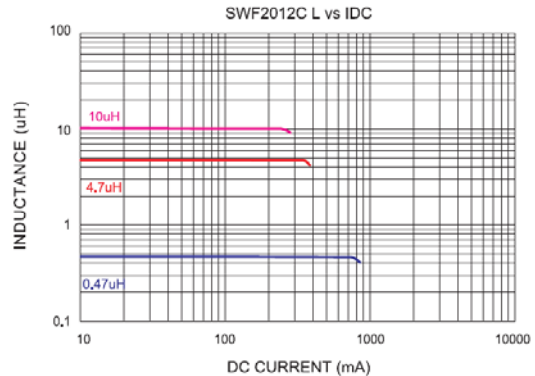
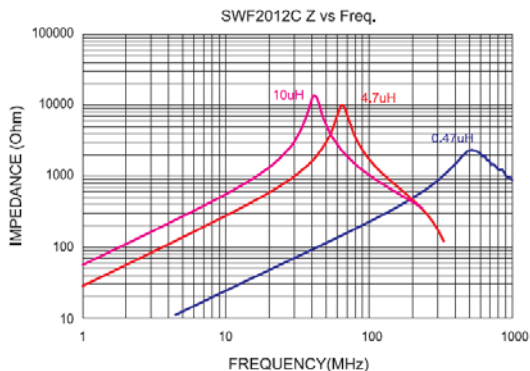

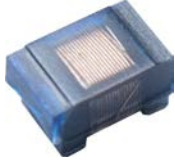
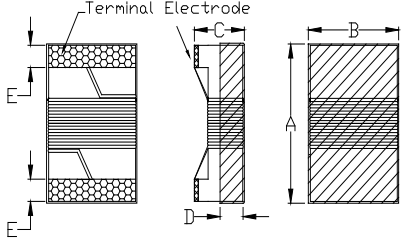

■ Dimensions

Chip Size	
A	2.90 max.
B	2.50 max.
C	2.10 max.
D	1.20 ref.
E	0.55±0.10

Units: mm

■ Specifications

Part Number	Inductance (uH)	Test Frequency (Hz)	Q min.	Test Frequency (MHz)	SRF (MHz) min.	DC Resistance (Ω) max.	Rated Current (mA) max.
SWF2520CF-1R0□	1.00	0.5V/7.96M	12	7.96	345	0.13	1000
SWF2520CF-1R5□	1.50	0.5V/7.96M	12	7.96	100	0.17	850
SWF2520CF-2R2□	2.20	0.5V/7.96M	12	7.96	78	0.21	775
SWF2520CF-3R3□	3.30	0.5V/7.96M	12	7.96	48	0.26	715
SWF2520CF-4R7□	4.70	0.5V/7.96M	12	7.96	46	0.52	505
SWF2520CF-6R8□	6.80	0.5V/7.96M	12	7.96	33	0.72	432
SWF2520CF-8R2□	8.20	0.5V/2.52M	12	2.52	30	0.76	410
SWF2520CF-100□	10.0	0.5V/2.52M	12	2.52	28	0.86	392
SWF2520CF-150□	15.0	0.5V/2.52M	12	2.52	21	1.09	342
SWF2520CF-220□	22.0	0.5V/2.52M	12	2.52	18	1.96	260
SWF2520CF-330□	33.0	0.5V/2.52M	12	2.52	15	2.47	236

□ : K=±10% , M=±20%

■ Impedance vs Frequency, DC Bias Characteristics (Typical)

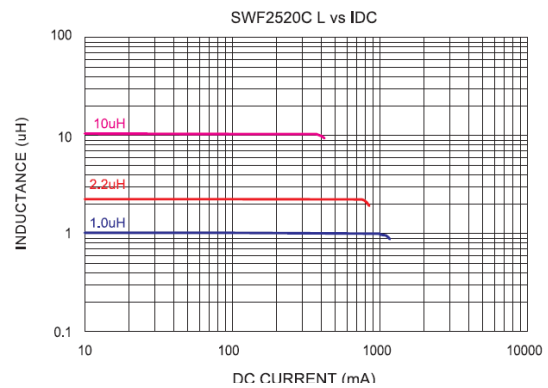
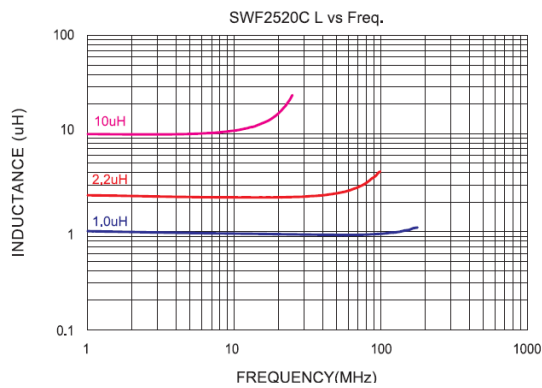

SWF 3225CF Series (1210 inch)



■ Dimensions

Chip Size	
A	3.60 max.
B	2.80 max.
C	2.60 max.
D	0.80 ref.
E	0.55±0.10

Units: mm

■ Specifications

Part Number	Inductance (uH)	Test Frequency (Hz)	Q min.	Test Frequency (MHz)	SRF (MHz) min.	DCR (Ω) max.	Rated Current (mA) max.
SWF3225CF-1R0□	1.00	0.5V/7.96M	10	7.96	290	0.12	1200
SWF3225CF-1R5□	1.50	0.5V/7.96M	10	7.96	260	0.13	1000
SWF3225CF-2R2□	2.20	0.5V/7.96M	10	7.96	190	0.17	880
SWF3225CF-3R3□	3.30	0.5V/7.96M	10	7.96	64	0.22	775
SWF3225CF-4R7□	4.70	0.5V/7.96M	10	7.96	54	0.26	710
SWF3225CF-6R8□	6.80	0.5V/7.96M	10	7.96	34	0.30	660
SWF3225CF-100□	10.0	0.5V/2.52M	10	2.52	25	0.39	570
SWF3225CF-150□	15.0	0.5V/2.52M	10	2.52	17	0.66	440
SWF3225CF-220□	22.0	0.5V/2.52M	10	2.52	16	0.82	400
SWF3225CF-330□	33.0	0.5V/2.52M	10	2.52	12	1.50	285
SWF3225CF-390□	39.0	0.5V/2.52M	10	2.52	12	1.66	270
SWF3225CF-470□	47.0	0.5V/2.52M	10	2.52	10	1.90	260
SWF3225CF-680□	68.0	0.5V/2.52M	10	2.52	9.0	2.29	235
SWF3225CF-101□	100.0	0.5V/1M	10	1.00	7.0	3.48	190
SWF3225CF-151□	150.0	0.5V/1M	10	1.00	5.0	6.55	140
SWF3225CF-221□	220.0	0.5V/1M	10	1.00	4.0	8.23	115
SWF3225CF-331□	330.0	0.5V/1M	10	1.00	2.8	13.7	98
SWF3225CF-471□	470.0	0.5V/1M	10	1.00	2.6	18.1	86
SWF3225CF-681□	680.0	0.5V/1M	10	1.00	2.3	22.0	76

□ : K=±10% , M=±20%

■ Impedance vs Frequency, DC Bias Characteristics (Typical)

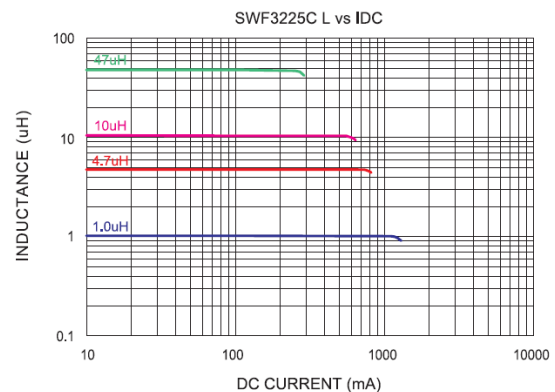
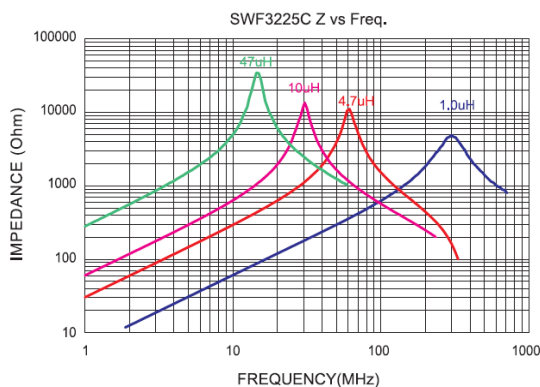



■ Dimensions

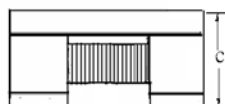

Dimension	unit: mm
A	3.25±0.15
B	2.50±0.15
C	2.30±0.15

■ Specifications

TAI-TECH Part Number	Inductance (uH)	Tolerance	Q min.	Test Frequency (MHz)	Rated Current (mA) max.	DCR (Ω) max.	SRF (MHz) min.
WIH 3225F-100□	10.0	K,M	15	2.52	240	0.36	30
WIH 3225F-220□	22.0	K,M	15	2.52	185	0.77	21
WIH 3225F-390□	39.0	K,M	15	2.52	145	1.90	11
WIH 3225F-470□	47.0	K,M	15	2.52	135	1.64	14
WIH 3225F-680□	68.0	K,M	15	2.52	105	2.8	12
WIH 3225F-151□	150.0	K,M	20	0.796	70	6.1	8
WIH 3225F-221□	220	K,M	20	0.796	60	8.4	7

Note:

Rated Current : Based on inductance change ($\Delta L/L_0 : \leq 30\%$) @ ambient temp. 25°C

Rated Current (I_{rms}) : Based on temperature rise ($\Delta T : 40^\circ\text{C}$) Max



■ Dimensions

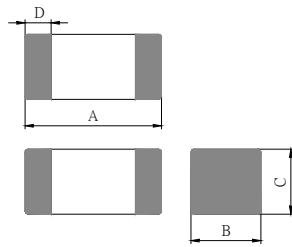

Dimensions	
A	0.60±0.05
B	0.30±0.05
C	0.30±0.05
D	0.15±0.05

Units: mm

■ Specifications

Tai-Tech Part Number	Inductance (nH)	Test Frequency (Hz)	Q min.	Rated Current (mA) max	DCR (Ω) max.	SRF (MHz) min.
HCI0603LF-0N8S	0.8±0.3	100M / 50mV	4	500	0.10	>10000
HCI0603LF-1N0S	1.0±0.3	100M / 50mV	4	470	0.11	>10000
HCI0603LF-1N2S	1.2±0.3	100M / 50mV	4	450	0.12	>10000
HCI0603LF-1N5S	1.5±0.3	100M / 50mV	4	430	0.13	>10000
HCI0603LF-1N8S	1.8±0.3	100M / 50mV	4	390	0.16	>10000
HCI0603LF-2N0S	2.0±0.3	100M / 50mV	4	380	0.17	>10000
HCI0603LF-2N2S	2.2±0.3	100M / 50mV	4	360	0.19	8800
HCI0603LF-2N4S	2.4±0.3	100M / 50mV	4	350	0.20	8300
HCI0603LF-2N7S	2.7±0.3	100M / 50mV	4	340	0.21	7700
HCI0603LF-3N0S	3.0±0.3	100M / 50mV	4	330	0.22	7200
HCI0603LF-3N3S	3.3±0.3	100M / 50mV	4	320	0.23	6700
HCI0603LF-3N6S	3.6±0.3	100M / 50mV	4	310	0.25	6400
HCI0603LF-3N9S	3.9±0.3	100M / 50mV	4	300	0.27	6000
HCI0603LF-4N3S	4.3±0.3	100M / 50mV	4	280	0.30	5700
HCI0603LF-4N7S	4.7±0.3	100M / 50mV	4	280	0.30	5300
HCI0603LF-5N1S	5.1±0.3	100M / 50mV	4	270	0.33	5000
HCI0603LF-5N6S	5.6±0.3	100M / 50mV	4	260	0.36	4600

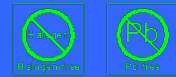

■ Specifications

Tai-Tech Part Number	Inductance (nH)	Test Frequency (Hz)	Q min.	Rated Current (mA) max	DCR (Ω) max.	SRF (MHz) min.
HCI0603LF-6N2S	6.2±0.3	100M / 50mV	4	250	0.38	4200
HCI0603LF-6N8J	6.8±5%	100M / 50mV	4	250	0.39	3900
HCI0603LF-7N5J	7.5±5%	100M / 50mV	4	240	0.41	3600
HCI0603LF-8N2J	8.2±5%	100M / 50mV	4	230	0.45	3400
HCI0603LF-9N1J	9.1±5%	100M / 50mV	4	220	0.48	3200
HCI0603LF-10NJ	10±5%	100M / 50mV	4	220	0.51	2900
HCI0603LF-12NJ	12±5%	100M / 50mV	4	190	0.68	2700
HCI0603LF-15NJ	15±5%	100M / 50mV	4	180	0.71	2300
HCI0603LF-18NJ	18±5%	100M / 50mV	4	170	0.81	2100
HCI0603LF-22NJ	22±5%	100M / 50mV	4	150	1.00	1800
HCI0603LF-27NJ	27±5%	100M / 50mV	4	120	1.35	1800
HCI0603LF-33NJ	33±5%	100M / 50mV	4	110	1.47	1700
HCI0603LF-39NJ	39±5%	100M / 50mV	4	100	1.72	1500
HCI0603LF-47NJ	47±5%	100M / 50mV	4	100	1.90	1300
HCI0603LF-56NJ	56±5%	100M / 50mV	4	80	2.27	1100
HCI0603LF-68NJ	68±5%	100M / 50mV	4	80	2.66	1100
HCI0603LF-82NJ	82±5%	100M / 50mV	4	70	3.37	1000
HCI0603LF-R10J	100±5%	100M / 50mV	4	60	3.74	900

- Rated current: based on temperature rise test
- In compliance with EIA 595

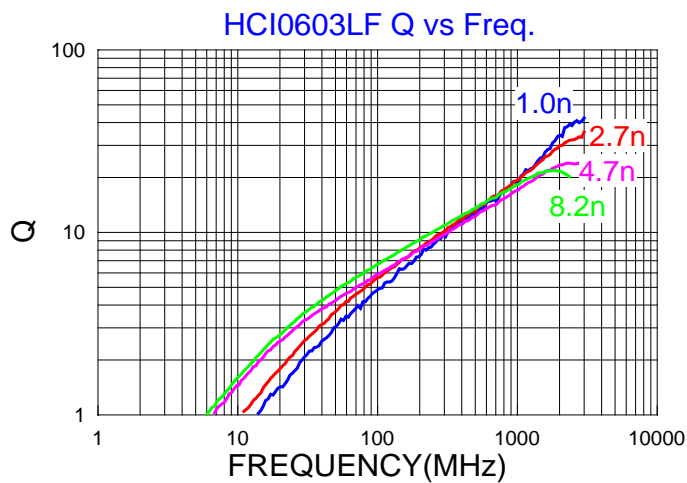
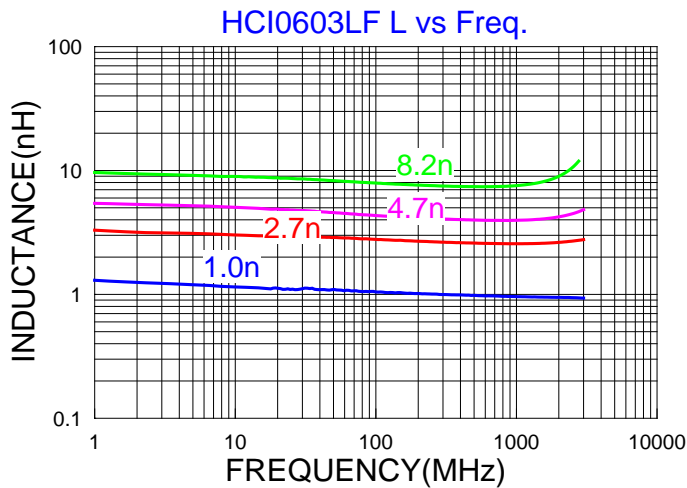
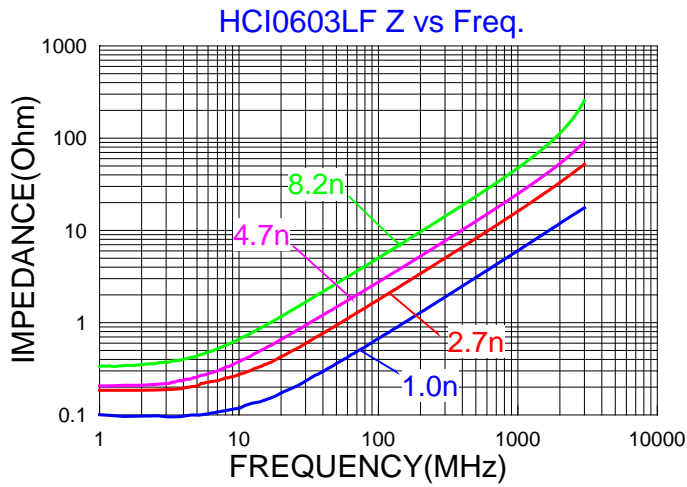



■ Dimensions

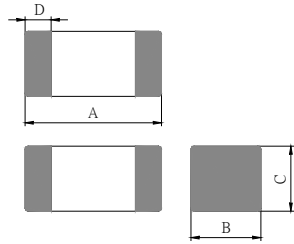

Dimensions	
A	1.00±0.15
B	0.50±0.15
C	0.50±0.15
D	0.25±0.10

Units: mm

■ Specifications

Tai-Tech Part Number	Inductance (nH)	Test Frequency (Hz)	Q min.	Rated Current (mA) max	DCR (Ω) max.	SRF (MHz) min.
HCI1005LF-1N0S	1.0±0.3	100M / 50mV	7	400	0.10	10000
HCI1005LF-1N2S	1.2±0.3	100M / 50mV	7	400	0.10	10000
HCI1005LF-1N5S	1.5±0.3	100M / 50mV	7	300	0.10	6000
HCI1005LF-1N8S	1.8±0.3	100M / 50mV	7	300	0.10	6000
HCI1005LF-2N0S	2.0±0.3	100M / 50mV	7	300	0.20	6000
HCI1005LF-2N2S	2.2±0.3	100M / 50mV	7	300	0.20	6000
HCI1005LF-2N4S	2.4±0.3	100M / 50mV	7	300	0.20	6000
HCI1005LF-2N7S	2.7±0.3	100M / 50mV	7	300	0.20	6000
HCI1005LF-3N0S	3.0±0.3	100M / 50mV	7	300	0.20	6000
HCI1005LF-3N3S	3.3±0.3	100M / 50mV	7	300	0.20	6000
HCI1005LF-3N6S	3.6±0.3	100M / 50mV	7	300	0.20	4000
HCI1005LF-3N9S	3.9±0.3	100M / 50mV	7	300	0.20	4000
HCI1005LF-4N3S	4.3±0.3	100M / 50mV	7	300	0.20	4000
HCI1005LF-4N7S	4.7±0.3	100M / 50mV	7	300	0.20	4000
HCI1005LF-5N1S	5.1±0.3	100M / 50mV	7	300	0.30	4000
HCI1005LF-5N6S	5.6±0.3	100M / 50mV	7	300	0.30	4000
HCI1005LF-6N2S	6.2±0.3	100M / 50mV	7	300	0.30	3900
HCI1005LF-6N8J	6.8±5%	100M / 50mV	7	300	0.30	3900
HCI1005LF-7N5J	7.5±5%	100M / 50mV	7	300	0.40	3700



■ Specifications

Tai-Tech Part Number	Inductance (nH)	Test Frequency (Hz)	Q min.	Rated Current (mA) max	DCR (Ω) max.	SRF (MHz) min.
HCI1005LF-8N2J	8.2±5%	100M / 50mV	7	300	0.40	3600
HCI1005LF-9N1J	9.1±5%	100M / 50mV	7	300	0.40	3400
HCI1005LF-10NJ	10±5%	100M / 50mV	7	300	0.40	3200
HCI1005LF-12NJ	12±5%	100M / 50mV	8	300	0.50	2700
HCI1005LF-15NJ	15±5%	100M / 50mV	8	300	0.50	2300
HCI1005LF-18NJ	18±5%	100M / 50mV	8	300	0.60	2100
HCI1005LF-20NJ	20±5%	100M / 50mV	8	300	0.60	2000
HCI1005LF-22NJ	22±5%	100M / 50mV	8	300	0.60	1900
HCI1005LF-27NJ	27±5%	100M / 50mV	8	300	0.70	1600
HCI1005LF-33NJ	33±5%	100M / 50mV	8	200	0.80	1300
HCI1005LF-39NJ	39±5%	100M / 50mV	8	200	1.00	1200
HCI1005LF-47NJ	47±5%	100M / 50mV	8	200	1.10	1100
HCI1005LF-56NJ	56±5%	100M / 50mV	8	200	1.20	750
HCI1005LF-68NJ	68±5%	100M / 50mV	8	180	1.40	750
HCI1005LF-82NJ	82±5%	100M / 50mV	8	150	2.40	750
HCI1005LF-R10J	100±5%	100M / 50mV	8	150	2.60	700
HCI1005LF-R12J	120±5%	100M / 50mV	8	150	2.80	600
HCI1005LF-R15J	150±5%	100M / 50mV	8	100	3.20	550
HCI1005LF-R18J	180±5%	100M / 50mV	8	100	3.70	500
HCI1005LF-R22J	220±5%	100M / 50mV	8	100	4.00	400
HCI1005LF-R27J	270±5%	100M / 50mV	8	50	4.50	350
HCI1005LF-R33J	330±5%	100M / 50mV	8	50	7.00	350

- Rated current: based on temperature rise test
- In compliance with EIA 595

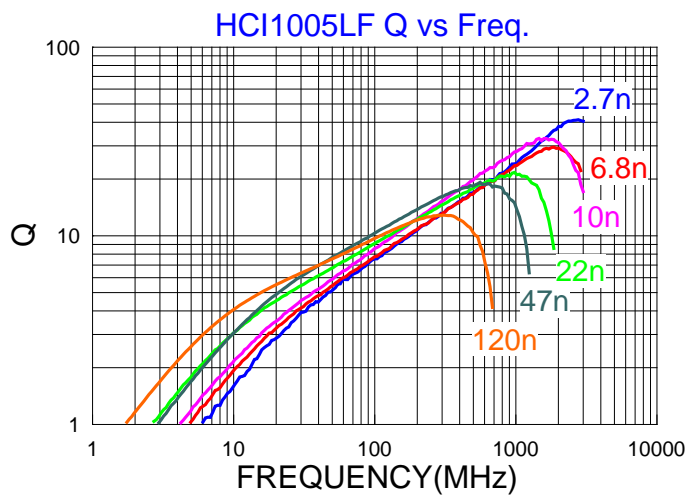
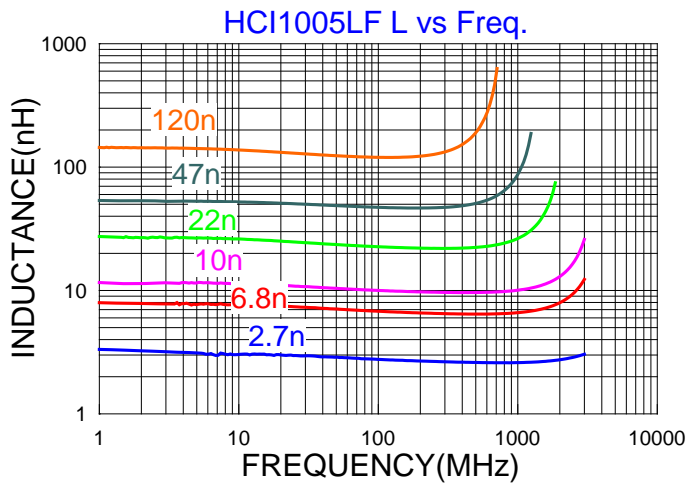
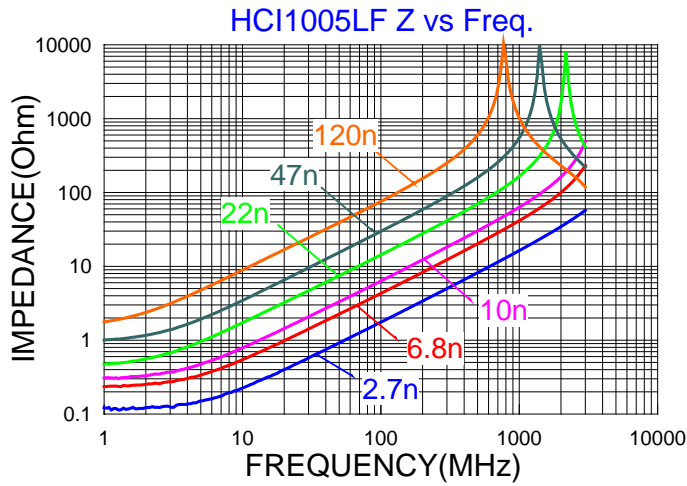



■ Dimensions

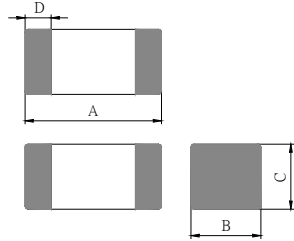

Dimensions	
A	1.60±0.20
B	0.80±0.20
C	0.80±0.20
D	0.30±0.20

Units: mm

■ Specifications

Tai-Tech Part Number	Inductance (nH)	Test Frequency (Hz)	Q min.	Rated Current (mA) max	DCR (Ω) max.	SRF (MHz) min.
HCl1608LF-1N5S	1.5±0.3	100M / 50mV	8	400	0.10	10000
HCl1608LF-1N8S	1.8±0.3	100M / 50mV	8	400	0.12	9800
HCl1608LF-2N2S	2.2±0.3	100M / 50mV	8	400	0.20	7600
HCl1608LF-2N7S	2.7±0.3	100M / 50mV	8	400	0.20	7000
HCl1608LF-3N3S	3.3±0.3	100M / 50mV	8	400	0.20	6200
HCl1608LF-3N9S	3.9±0.3	100M / 50mV	8	400	0.25	5600
HCl1608LF-4N7S	4.7±0.3	100M / 50mV	8	400	0.30	4800
HCl1608LF-5N6S	5.6±0.3	100M / 50mV	8	400	0.30	4600
HCl1608LF-6N8J	6.8±5%	100M / 50mV	8	400	0.35	4200
HCl1608LF-8N2J	8.2±5%	100M / 50mV	8	400	0.35	3600
HCl1608LF-10NJ	10±5%	100M / 50mV	8	300	0.40	3200
HCl1608LF-12NJ	12±5%	100M / 50mV	8	300	0.40	2800
HCl1608LF-15NJ	15±5%	100M / 50mV	8	300	0.45	2600
HCl1608LF-18NJ	18±5%	100M / 50mV	8	300	0.60	2400
HCl1608LF-22NJ	22±5%	100M / 50mV	8	300	0.60	2000
HCl1608LF-27NJ	27±5%	100M / 50mV	8	300	0.80	1900
HCl1608LF-33NJ	33±5%	100M / 50mV	8	300	0.80	1600
HCl1608LF-39NJ	39±5%	100M / 50mV	8	300	1.00	1400
HCl1608LF-47NJ	47±5%	100M / 50mV	8	200	1.00	1200



■ Specifications

Tai-Tech Part Number	Inductance (nH)	Test Frequency (Hz)	Q min.	Rated Current (mA) max	DCR (Ω) max.	SRF (MHz) min.
HCI1608LF-56NJ	56 \pm 5%	100M / 50mV	8	200	1.00	1000
HCI1608LF-68NJ	68 \pm 5%	100M / 50mV	8	200	1.00	900
HCI1608LF-82NJ	82 \pm 5%	100M / 50mV	8	200	1.00	800
HCI1608LF-R10J	100 \pm 5%	100M / 50mV	8	200	1.40	700
HCI1608LF-R12J	120 \pm 5%	100M / 50mV	8	150	1.60	600
HCI1608LF-R15J	150 \pm 5%	100M / 50mV	8	150	1.80	500
HCI1608LF-R18J	180 \pm 5%	100M / 50mV	8	150	1.80	500

- Rated current: based on temperature rise test
- In compliance with EIA 595

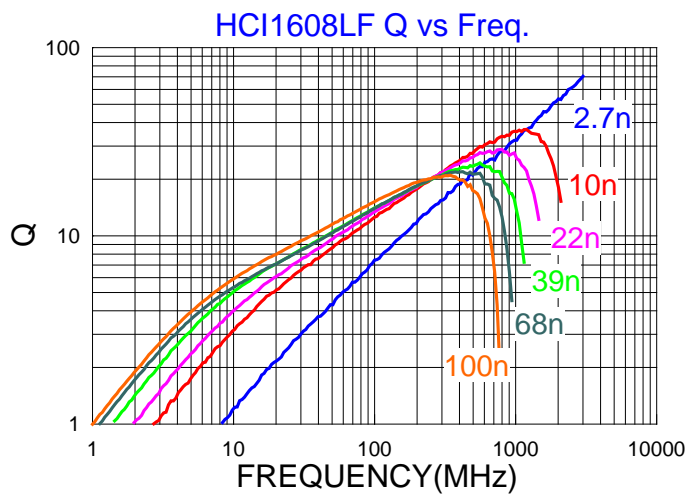
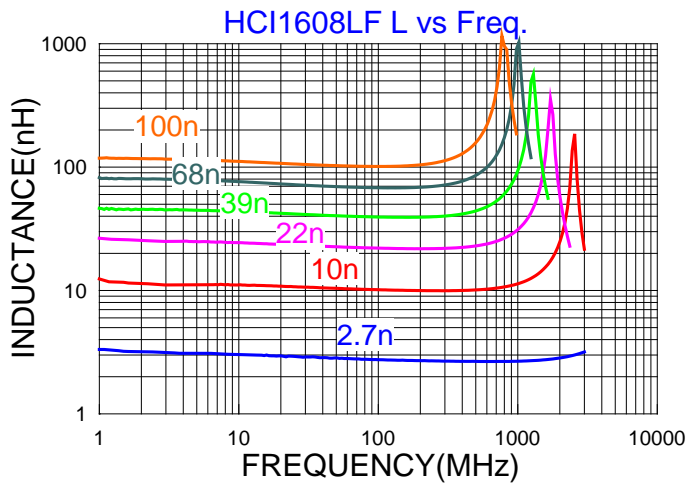
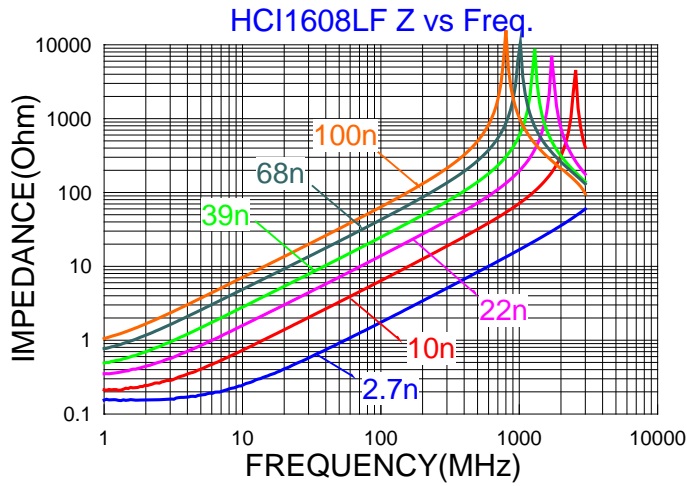

High Frequency Wire Wound Chip Inductors

SWI 0402PF Series (0402 inch)

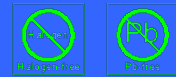

■ Dimensions

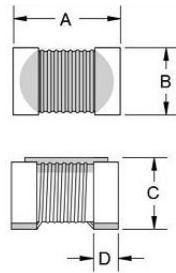

Chip Size	
A	1.09±0.20
B	0.60±0.20
C	0.56±0.20
D	0.20±0.15

Units: mm

■ Specifications

Part Number	Inductance (nH)	Tolerance	Test Frequency (Hz)	Q @ 250MHz min.	IDC (mA) max.	DCR (Ω) max.	SRF (MHz) min.
SWI0402PF-5N6□	5.6	S,J	20	0.1V/250M	760	0.083	4.80
SWI0402PF-6N8□	6.8	J,K	20	0.1V/250M	680	0.083	4.80
SWI0402PF-8N2□	8.2	J,K	22	0.1V/250M	680	0.100	4.40
SWI0402PF-8N7□	8.7	J,K	18	0.1V/250M	480	0.200	4.10
SWI0402PF-10N□	10	J,K	21	0.1V/250M	480	0.200	3.90
SWI0402PF-13N□	13	J,K	24	0.1V/250M	440	0.210	3.45
SWI0402PF-16N□	16	J,K	24	0.1V/250M	560	0.220	3.10
SWI0402PF-18N□	18	J,K	25	0.1V/250M	420	0.230	3.10
SWI0402PF-20N□	20	J,K	25	0.1V/250M	420	0.25	3.00
SWI0402PF-22N□	22	J,K	25	0.1V/250M	400	0.30	2.80
SWI0402PF-23N□	23	J,K	22	0.1V/250M	400	0.30	2.72
SWI0402PF-24N□	24	J,K	25	0.1V/250M	400	0.30	2.70
SWI0402PF-27N□	27	J,K	24	0.1V/250M	400	0.30	2.48
SWI0402PF-30N□	30	J,K	25	0.1V/250M	400	0.35	2.35
SWI0402PF-33N□	33	J,K	24	0.1V/250M	400	0.40	2.35
SWI0402PF-36N□	36	J,K	24	0.1V/250M	320	0.44	2.32
SWI0402PF-39N□	39	J,K	25	0.1V/250M	200	0.55	2.10
SWI0402PF-47N□	47	J,K	20	0.1V/250M	150	0.83	2.10
SWI0402PF-56N□	56	J,K	22	0.1V/250M	100	0.97	1.76
SWI0402PF-68N□	68	J,K	22	0.1V/250M	100	1.12	1.62
SWI0402PF-82N□	82	J,K	20	0.1V/250M	50	1.55	1.26
SWI0402PF-R10□	100	J,K	20	0.1V/250M	30	2.00	1.16

C=±0.2nH , S=±0.3nH , G=±2% , J=±5% , K=±10%



■ Dimensions

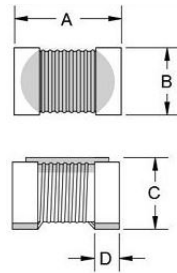

Chip Size	
A	1.55±0.20
B	0.96±0.20
C	0.90±0.20
D	0.38 ref.

Units: mm

■ Specifications

Part Number	Inductance (nH)	Tolerance	Test Frequency (Hz)	Q @ 250MHz min.	IDC (mA) max.	DCR (Ω) max.	SRF (MHz) min.
SWI0603PF-2N0□	2.0	C,S	0.1V/250M	13	700	0.07	8000
SWI0603PF-4N7□	4.7	C,S	0.1V/250M	20	700	0.12	5800
SWI0603PF-7N5□	7.5	J	0.1V/250M	30	750	0.13	4200
SWI0603PF-10N□	10	J	0.1V/250M	31	700	0.13	4800
SWI0603PF-12N□	12	J	0.1V/250M	35	700	0.13	4000
SWI0603PF-15N□	15	J	0.1V/250M	35	700	0.13	4000
SWI0603PF-23N□	23	J	0.1V/250M	38	700	0.25	2900
SWI0603PF-47N□	47	J	0.1V/200M	38	600	0.35	2000
SWI0603PF-56N□	56	J	0.1V/200M	38	600	0.37	1900
SWI0603PF-68N□	68	J	0.1V/200M	37	600	0.43	1700
SWI0603PF-82N□	82	J	0.1V/150M	34	400	0.71	1700
SWI0603PF-R10□	100	J	0.1V/150M	34	400	0.78	1400
SWI0603PF-R12□	120	J	0.1V/150M	32	300	0.84	1300
SWI0603PF-R14□	140	J	0.1V/150M	28	280	0.87	920
SWI0603PF-R15□	150	J	0.1V/150M	28	280	0.96	990
SWI0603PF-R27□	270	J	0.1V/100M	24	170	2.36	900
SWI0603PF-R36□	360	J	0.1V/100M	24	150	3.50	700

C=±0.2nH , S=±0.3nH , G=±2% , J=±5% , K=±10%

SWI 0402F Series (0402 inch)

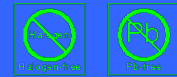

■ Dimensions

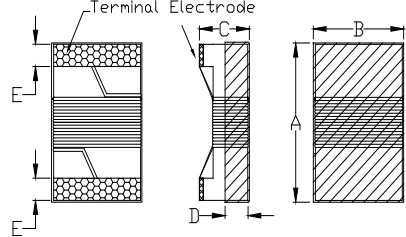



Chip Size	
A	1.09±0.10
B	0.60±0.10
C	0.56±0.10
D	0.20±0.15
E	0.23±0.10

Units: mm

■ Specifications

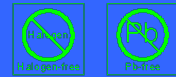
Part Number	Inductance (nH)	Tolerance	Q min.	Test Frequency (Hz)	I _{rms} (mA) max.	DCR (Ω) max.	SRF (GHz) min.
SWI0402F-1N0□	1.0	S.J	16	0.1V/250M	1360	0.045	12.7
SWI0402F-1N9□	1.9	S.J	16	0.1V/250M	1040	0.070	11.30
SWI0402F-2N0□	2.0	S.J	16	0.1V/250M	1040	0.070	11.10
SWI0402F-2N2□	2.2	S.J	19	0.1V/250M	960	0.070	10.80
SWI0402F-2N4□	2.4	S.J	15	0.1V/250M	790	0.068	10.50
SWI0402F-2N7□	2.7	S.J	16	0.1V/250M	640	0.120	10.40
SWI0402F-3N3□	3.3	S.J	19	0.1V/250M	840	0.066	7.00
SWI0402F-3N6□	3.6	S.J	19	0.1V/250M	840	0.066	6.80
SWI0402F-3N9□	3.9	S.J	19	0.1V/250M	840	0.066	6.00
SWI0402F-4N3□	4.3	S.J	18	0.1V/250M	700	0.091	6.00
SWI0402F-4N7□	4.7	S.J	15	0.1V/250M	640	0.130	4.77
SWI0402F-5N1□	5.1	S.J	20	0.1V/250M	800	0.083	4.80
SWI0402F-5N6□	5.6	S.J	20	0.1V/250M	760	0.083	4.80
SWI0402F-6N2□	6.2	J.K	20	0.1V/250M	760	0.083	4.80
SWI0402F-6N8□	6.8	J.K	20	0.1V/250M	680	0.083	4.80
SWI0402F-7N5□	7.5	J.K	22	0.1V/250M	680	0.100	4.80
SWI0402F-8N2□	8.2	J.K	22	0.1V/250M	680	0.100	4.40
SWI0402F-8N7□	8.7	J.K	18	0.1V/250M	480	0.200	4.10
SWI0402F-9N0□	9.0	J.K	22	0.1V/250M	680	0.100	4.16
SWI0402F-9N1□	9.1	J.K	22	0.1V/250M	680	0.100	4.16
SWI0402F-9N5□	9.5	J.K	18	0.1V/250M	480	0.200	4.00
SWI0402F-10N□	10	J.K	21	0.1V/250M	480	0.200	3.90
SWI0402F-11N□	11	J.K	24	0.1V/250M	640	0.120	3.68
SWI0402F-12N□	12	J.K	24	0.1V/250M	640	0.120	3.60
SWI0402F-13N□	13	J.K	24	0.1V/250M	440	0.210	3.45
SWI0402F-15N□	15	J.K	24	0.1V/250M	560	0.170	3.28
SWI0402F-16N□	16	J.K	24	0.1V/250M	560	0.220	3.10
SWI0402F-18N□	18	J.K	25	0.1V/250M	420	0.230	3.10
SWI0402F-19N□	19	J.K	24	0.1V/250M	480	0.200	3.04
SWI0402F-20N□	20	J.K	25	0.1V/250M	420	0.25	3.00
SWI0402F-22N□	22	J.K	25	0.1V/250M	400	0.30	2.80
SWI0402F-23N□	23	J.K	22	0.1V/250M	400	0.30	2.72
SWI0402F-24N□	24	J.K	25	0.1V/250M	400	0.30	2.70



■ Specifications

Part Number	Inductance (nH)	Tolerance	Q min.	Test Frequency (Hz)	I rms (mA) max.	DCR (Ω) max.	SRF (GHz) min.
SWI0402F-27N□	27	J.K	24	0.1V/250M	400	0.30	2.48
SWI0402F-30N□	30	J.K	25	0.1V/250M	400	0.35	2.35
SWI0402F-33N□	33	J.K	24	0.1V/250M	400	0.40	2.35
SWI0402F-36N□	36	J.K	24	0.1V/250M	320	0.44	2.32
SWI0402F-39N□	39	J.K	25	0.1V/250M	200	0.55	2.10
SWI0402F-40N□	40	J.K	24	0.1V/250M	320	0.44	2.24
SWI0402F-43N□	43	J.K	25	0.1V/250M	100	0.81	2.03
SWI0402F-47N□	47	J.K	20	0.1V/250M	150	0.83	2.10
SWI0402F-51N□	51	J.K	25	0.1V/250M	100	0.82	1.75
SWI0402F-56N□	56	J.K	22	0.1V/250M	100	0.97	1.76
SWI0402F-68N□	68	J.K	22	0.1V/250M	100	1.12	1.62
SWI0402F-82N□	82	J.K	20	0.1V/250M	50	1.55	1.26
SWI0402F-R10□	100	J.K	20	0.1V/250M	30	2.00	1.16

□ : S=±0.3nH, J=±5%, K=±10%

■ Impedance vs Frequency, DC Bias Characteristics (Typical)

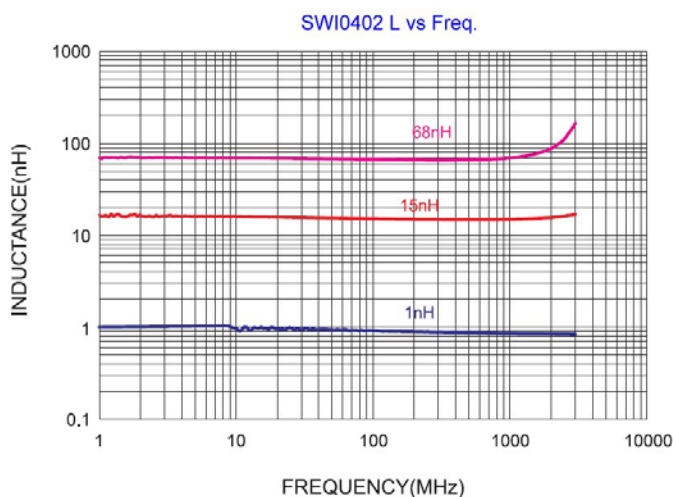
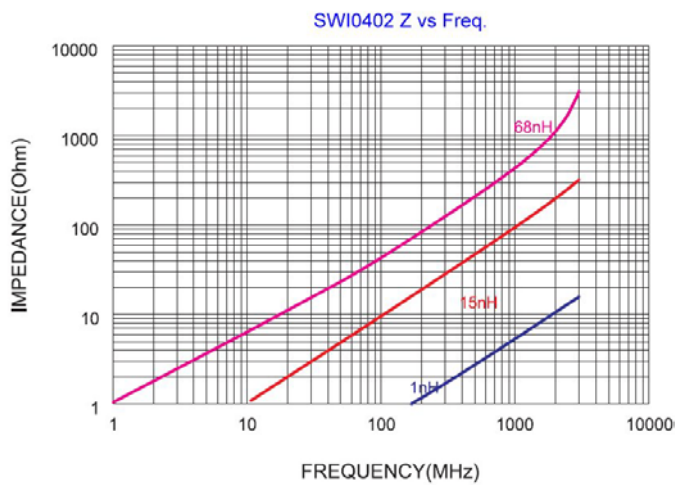

SWI 0603F Series (0603 inch)

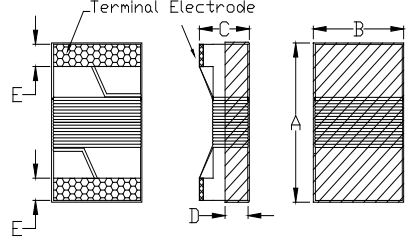

■ Dimensions

Chip Size	
A	1.80 max.
B	1.20 max.
C	1.20 max.
D	0.38 ref.
E	0.35±0.10

Units: mm

■ Specifications

Part Number	Inductance (nH)	Tolerance	Test Frequency (Hz)	Q @ 250MHz min.	I rms (mA) max.	DCR (Ω) max.	SRF (MHz) min.
SWI0603F-2N0□	2.0	C,S	0.1V/250M	13	700	0.07	8000
SWI0603F-3N9□	3.9	C,S	0.1V/250M	22	700	0.07	6900
SWI0603F-4N7□	4.7	C,J,K	0.1V/250M	20	700	0.12	5800
SWI0603F-6N8□	6.8	C,J,K	0.1V/250M	27	700	0.08	5800
SWI0603F-8N2□	8.2	C,J,K	0.1V/250M	30	700	0.13	4200
SWI0603F-10N□	10	J,K	0.1V/250M	31	700	0.13	4800
SWI0603F-12N□	12	J,K	0.1V/250M	35	700	0.13	4000
SWI0603F-15N□	15	J,K	0.1V/250M	35	700	0.13	4000
SWI0603F-18N□	18	J,K	0.1V/250M	35	700	0.16	3100
SWI0603F-22N□	22	J,K	0.1V/250M	38	700	0.23	3000
SWI0603F-24N□	24	J,K	0.1V/250M	38	700	0.13	2800
SWI0603F-27N□	27	J,K	0.1V/250M	40	600	0.14	2800
SWI0603F-33N□	33	J,K	0.1V/250M	40	600	0.22	2300
SWI0603F-39N□	39	J	0.1V/250M	40	600	0.30	2200
SWI0603F-47N□	47	J,K	0.1V/200M	38	600	0.35	2000
SWI0603F-56N□	56	J,K	0.1V/200M	38	600	0.37	1900
SWI0603F-68N□	68	J,K	0.1V/200M	37	600	0.43	1700
SWI0603F-72N□	72	J,K	0.1V/150M	34	400	0.42	1700
SWI0603F-82N□	82	J,K	0.1V/150M	34	400	0.71	1700
SWI0603F-R10□	100	J,K	0.1V/150M	34	400	0.78	1400
SWI0603F-R12□	120	J,K	0.1V/150M	32	300	0.84	1300
SWI0603F-R15□	150	J,K	0.1V/150M	28	280	0.96	990
SWI0603F-R18□	180	J,K	0.1V/100M	25	240	1.52	990
SWI0603F-R22□	220	J,K	0.1V/100M	25	200	2.02	900
SWI0603F-R27□	270	J,K	0.1V/100M	24	170	2.36	900
SWI0603F-R33□	330	J,K	0.1V/100M	24	185	3.40	700
SWI0603F-R39□	390	J,K	0.1V/100M	24	100	3.60	900

□ : C=±0.2nH , S=±0.3nH , J=±5% , K=±10%

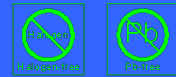

■ Impedance vs Frequency, DC Bias Characteristics (Typical)

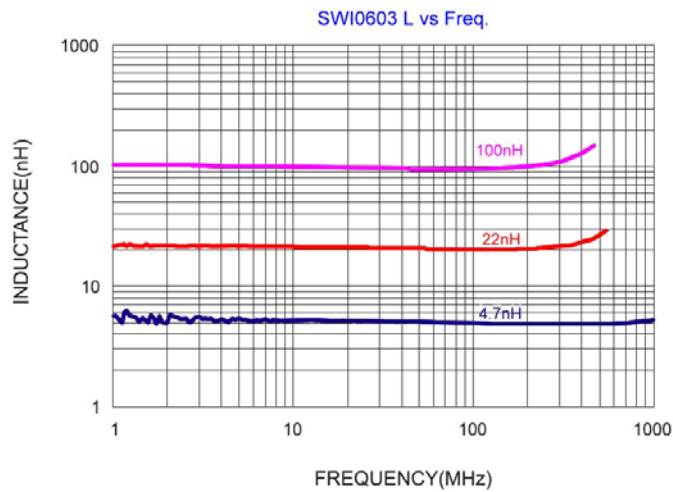
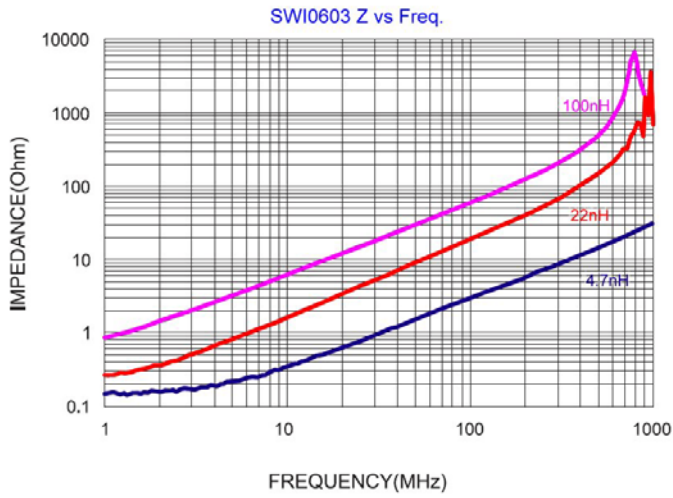

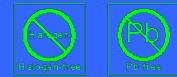

■ Dimensions

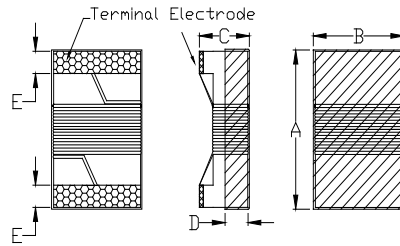

Chip Size	
A	2.29 max.
B	1.73 max.
C	1.52 max.
D	0.51 ref.
E	0.44±0.10

Units: mm

■ Specifications

Part Number	Inductance (nH)	Tolerance	Test Frequency (Hz)	Q @ Test Freq. min.	I _{rms} (mA) max.	DCR (Ω) max.	SRF (MHz) min.
SWI0805UF-2N8□	2.8	C,S	0.1V/250M	80/1500	800	0.06	7900
SWI0805UF-3N0□	3.0	C,S	0.1V/250M	65/1500	800	0.06	7900
SWI0805UF-3N3□	3.3	C,S	0.1V/250M	50/1500	600	0.08	7900
SWI0805UF-5N6□	5.6	C,S	0.1V/250M	65/1000	600	0.08	5500
SWI0805UF-6N8□	6.8	C,J	0.1V/250M	50/1000	600	0.11	5500
SWI0805UF-7N5□	7.5	C,J	0.1V/250M	50/1000	600	0.14	4500
SWI0805UF-8N2□	8.2	C,J	0.1V/250M	50/1000	600	0.12	4700
SWI0805UF-10N□	10	G,J	0.1V/250M	60/500	600	0.10	4200
SWI0805UF-12N□	12	G,J	0.1V/250M	50/500	600	0.15	4000
SWI0805UF-15N□	15	G,J	0.1V/250M	50/500	600	0.17	3400
SWI0805UF-18N□	18	G,J	0.1V/250M	50/500	600	0.20	3300
SWI0805UF-22N□	22	G,J	0.1V/250M	55/500	500	0.22	2600
SWI0805UF-24N□	24	G,J	0.1V/250M	50/500	500	0.22	2000
SWI0805UF-27N□	27	G,J	0.1V/250M	55/500	500	0.25	2500
SWI0805UF-33N□	33	G,J	0.1V/250M	60/500	500	0.27	2050
SWI0805UF-36N□	36	G,J	0.1V/250M	55/500	500	0.27	1700
SWI0805UF-39N□	39	G,J	0.1V/250M	60/500	500	0.29	2000
SWI0805UF-43N□	43	G,J	0.1V/200M	60/500	500	0.34	1650
SWI0805UF-47N□	47	G,J	0.1V/200M	60/500	500	0.31	1650
SWI0805UF-56N□	56	G,J	0.1V/200M	60/500	500	0.34	1550
SWI0805UF-68N□	68	G,J	0.1V/200M	60/500	500	0.38	1450
SWI0805UF-82N□	82	G,J	0.1V/150M	65/500	400	0.42	1300
SWI0805UF-91N□	91	G,J	0.1V/150M	65/500	400	0.48	1200
SWI0805UF-R10□	100	G,J	0.1V/150M	65/500	400	0.46	1200
SWI0805UF-R11□	110	G,J	0.1V/150M	50/250	400	0.48	1000
SWI0805UF-R12□	120	G,J	0.1V/150M	50/250	400	0.51	1100
SWI0805UF-R15□	150	G,J	0.1V/100M	50/250	400	0.56	920
SWI0805UF-R18□	180	G,J	0.1V/100M	50/250	400	0.64	870
SWI0805UF-R20□	200	G,J	0.1V/100M	50/250	400	0.68	860
SWI0805UF-R22□	220	G,J	0.1V/100M	50/250	400	0.70	850
SWI0805UF-R24□	240	G,J	0.1V/100M	44/250	350	1.00	690
SWI0805UF-R25□	250	G,J	0.1V/100M	45/250	350	1.20	660

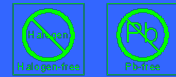

■ Specifications

Part Number	Inductance (nH)	Tolerance	Test Frequency (Hz)	Q @ Test Freq. min.	I _{rms} (mA) max.	DCR (Ω) max.	SRF (MHz) min.
SWI0805UF-R27□	270	G,J	0.1V/100M	48/250	350	1.00	650
SWI0805UF-R33□	330	G,J	0.1V/100M	48/250	310	1.40	600
SWI0805UF-R39□	390	G,J	0.1V/100M	48/250	290	1.50	560
SWI0805UF-R47□	470	G,J	0.1V/50M	33/100	250	1.70	375
SWI0805UF-R56□	560	G,J	0.1V/25M	23/50	230	1.90	340
SWI0805UF-R62□	620	G,J	0.1V/25M	23/50	210	2.20	220
SWI0805UF-R68□	680	G,J	0.1V/25M	23/50	190	2.20	188
SWI0805UF-R82□	820	G,J	0.1V/25M	23/50	180	2.35	215
SWI0805UF-1R0□	1000	G,J	0.1V/25M	20/50	170	2.5	100
SWI0805UF-1R2□	1200	G,J	0.1V/7.9M	18/25	170	2.5	100

□ : C=±0.2nH , S=±0.3nH , G=±2% , J=±5% , K=±10%

■ Impedance vs Frequency, DC Bias Characteristics (Typical)

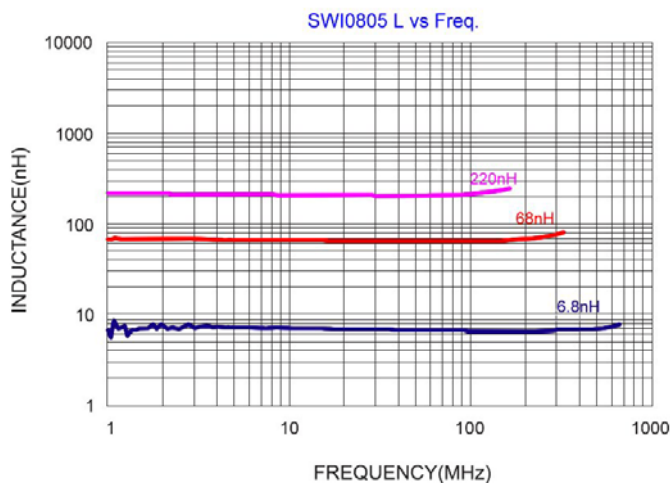
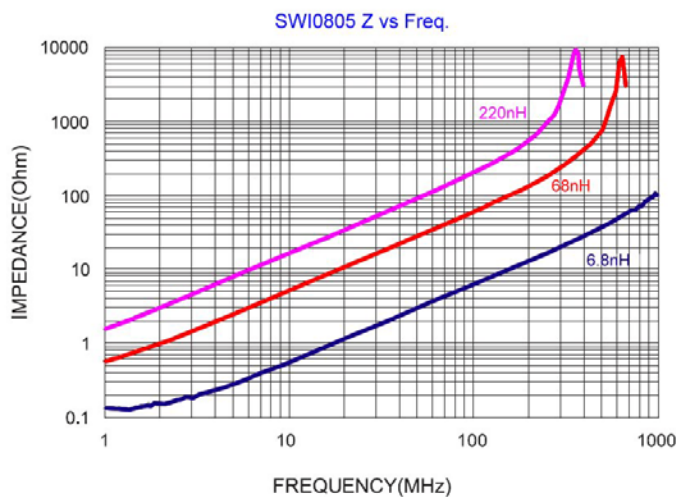

SWI 1008UF Series (1008 inch)

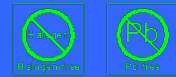

■ Dimensions

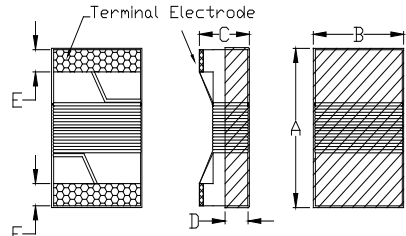



Chip Size	
A	2.92 max.
B	2.79 max.
C	2.20 max.
D	1.20 ref.
E	0.55±0.10

Units: mm

■ Specifications

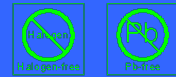
Part Number	Inductance (nH)	Tolerance	Test Frequency (Hz)	Q @ Test Freq. min.	I rms (mA) max.	DCR (Ω) max.	SRF (MHz) min.
SWI1008UF-10N□	10	G, J, K	0.1V/50M	50/500	1000	0.08	4100
SWI1008UF-12N□	12	G, J, K	0.1V/50M	50/500	1000	0.09	3300
SWI1008UF-15N□	15	G, J, K	0.1V/50M	50/500	1000	0.18	2500
SWI1008UF-18N□	18	G, J, K	0.1V/50M	50/350	1000	0.11	2500
SWI1008UF-22N□	22	G, J, K	0.1V/50M	55/350	1000	0.12	2400
SWI1008UF-27N□	27	G, J, K	0.1V/50M	55/350	1000	0.13	1600
SWI1008UF-33N□	33	G, J, K	0.1V/50M	60/350	1000	0.14	1600
SWI1008UF-39N□	39	G, J, K	0.1V/50M	60/350	1000	0.15	1500
SWI1008UF-47N□	47	G, J, K	0.1V/50M	65/350	1000	0.16	1500
SWI1008UF-56N□	56	G, J, K	0.1V/50M	65/350	1000	0.18	1300
SWI1008UF-68N□	68	G, J, K	0.1V/50M	65/350	1000	0.20	1300
SWI1008UF-82N□	82	G, J, K	0.1V/50M	60/350	1000	0.22	1000
SWI1008UF-R10□	100	G, J, K	0.1V/25M	60/350	650	0.56	1000
SWI1008UF-R12□	120	G, J, K	0.1V/25M	60/350	650	0.63	950
SWI1008UF-R15□	150	G, J, K	0.1V/25M	45/100	580	0.70	850
SWI1008UF-R18□	180	G, J, K	0.1V/25M	45/100	620	0.77	750
SWI1008UF-R22□	220	G, J, K	0.1V/25M	45/100	500	0.84	700
SWI1008UF-R27□	270	G, J, K	0.1V/25M	45/100	500	0.91	600
SWI1008UF-R33□	330	G, J, K	0.1V/25M	45/100	450	1.05	570
SWI1008UF-R39□	390	G, J, K	0.1V/25M	45/100	470	1.12	500
SWI1008UF-R47□	470	G, J, K	0.1V/25M	45/100	470	1.19	450
SWI1008UF-R56□	560	G, J, K	0.1V/25M	45/100	400	1.33	415
SWI1008UF-R62□	620	G, J, K	0.1V/25M	45/100	300	1.40	375
SWI1008UF-R68□	680	G, J, K	0.1V/25M	45/100	400	1.47	375
SWI1008UF-R75□	750	G, J, K	0.1V/25M	45/100	360	1.54	360
SWI1008UF-R82□	820	G, J, K	0.1V/25M	45/100	400	1.61	350
SWI1008UF-R91□	910	G, J, K	0.1V/25M	35/50	380	1.68	320
SWI1008UF-1R0□	1000	G, J, K	0.1V/25M	35/50	370	1.75	290
SWI1008UF-1R2□	1200	G, J, K	0.1V/7.9M	35/50	310	2.00	250
SWI1008UF-1R5□	1500	G, J, K	0.1V/7.9M	28/50	330	2.23	200
SWI1008UF-1R8□	1800	G, J, K	0.1V/7.9M	28/50	300	2.60	160
SWI1008UF-2R2□	2200	G, J, K	0.1V/7.9M	28/50	280	2.80	160



■ Specifications

Part Number	Inductance (nH)	Tolerance	Test Frequency (Hz)	Q @ Test Freq. min.	I rms (mA) max.	DCR (Ω) max.	SRF (MHz) min.
SWI1008UF-2R7□	2700	G, J,K	0.1V/7.9M	22/25	290	3.20	140
SWI1008UF-3R3□	3300	G, J,K	0.1V/7.9M	22/25	290	3.40	110
SWI1008UF-3R9□	3900	G, J,K	0.1V/7.9M	20/25	260	3.6	100
SWI1008UF-4R7□	4700	G, J,K	0.1V/7.9M	18/7.9	200	4	32
SWI1008UF-5R6□	5600	G, J,K	0.1V/7.9M	18/7.9	200	4.0	25
SWI1008UF-6R8□	6800	G, J,K	0.1V/7.9M	18/7.9	200	4.9	21
SWI1008UF-8R2□	8200	G, J,K	0.1V/7.9M	16 /7.9	170	6.0	16
SWI1008UF-100□	10000	G, J,K	0.1V/2.52M	15/7.9	170	8.0	14

□ : G=±2% , J=±5% , K=±10%

■ Impedance vs Frequency, DC Bias Characteristics (Typical)

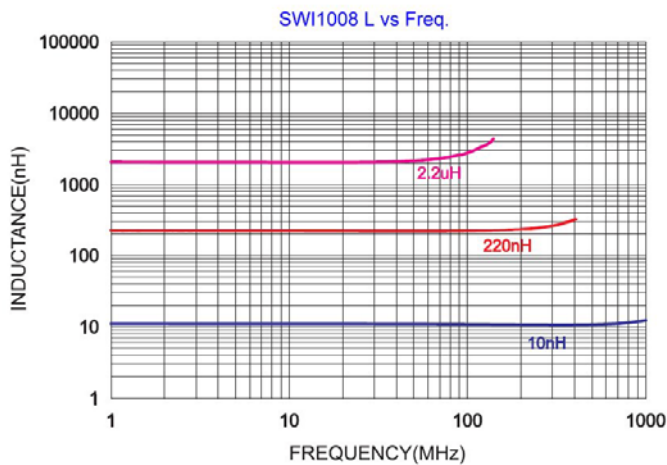
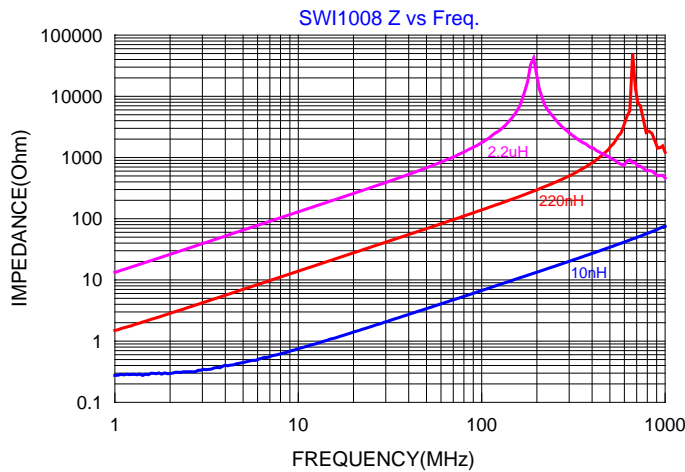



■ Dimensions

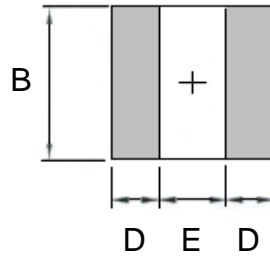
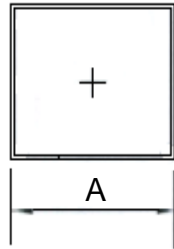

Dimensions	
A	2.00±0.20
B	1.60±0.20
C	1.50 max.
D	0.60 ref.
E	0.80 ref.

Units: mm



■ Specifications

Part Number	Inductance (uH) ±20%	Test Frequency (Hz)	SRF MHz (min)	RDC(Ω) Max.	Rated current (mA) Max.
PAS201615F-102	1000	0.1V/10K	4	38	20

Note:

1. Test frequency : Inductor(L) : 10KHz /0.1V;
2. All test data referenced to 25°C ambient.
3. Testing Instrument : L/Q: Agilent-4192A, Agilent-16334A ; Irms:CH3302,CH1320 ; SRF: Agilent-4291B ; Rdc: Agilent-34420A
4. Rated Current (Irms) will cause the coil temperature rise approximately Δt of 20°C .

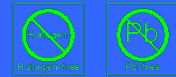

■ Dimensions

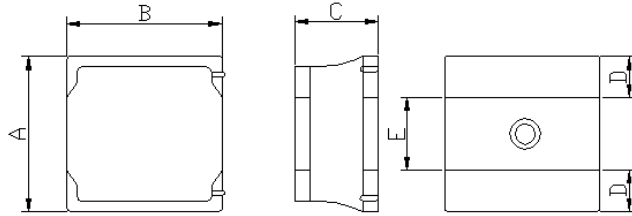

Dimensions	
A	3.00±0.20
B	3.00±0.20
C	1.00 max.
D	1.00 ref.
E	1.00 ref.

Units: mm

■ Specifications

Part Number	Inductance (uH) ±10%	Test Frequency (Hz)	SRF MHz (min)	DC Resistance (Ω) max.	Rated current (mA) max.
PAS3010EF-281K	280	10K	8.5	17.8	50

Note:

1. Test frequency : Inductor(L) : 10KHz /1V;
2. All test data referenced to 25°C ambient.
3. Testing Instrument : L/Q: Agilent-4192A, Agilent-16334A ; Irms:CH3302,CH1320 ; SRF: Agilent-4291B ; Rdc: Agilent-34420A
4. Rated Current (Irms) will cause the coil temperature rise approximately Δt of 20°C ..

■ DC Bias Characteristics (Typical)

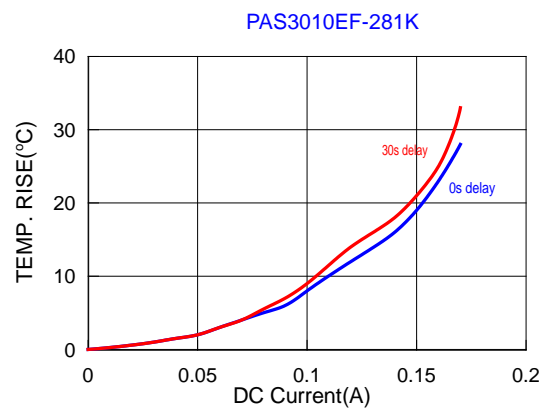
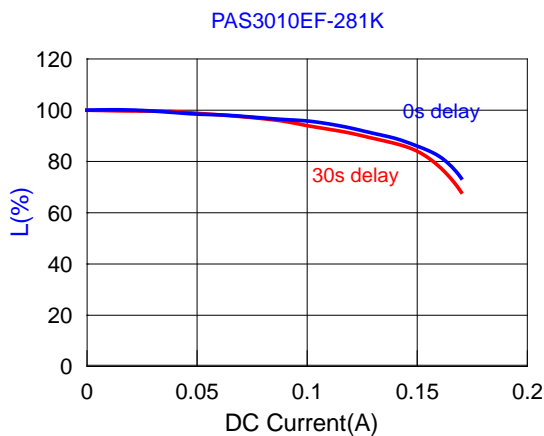

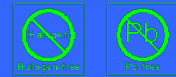

■ Dimensions

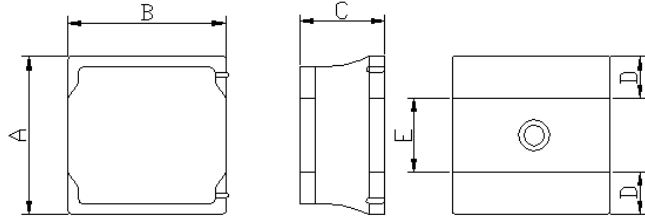

Dimensions	
A	3.00±0.20
B	3.00±0.20
C	1.20 max.
D	1.00 ref.
E	1.00 ref.

Units: mm

■ Specifications

Part Number	Inductance (uH)	Test Frequency (Hz)	SRF MHz (Typ)	DC Resistance (Ω) max.	Rated current (mA) max.
PAS3012EF-681K	680	10K	5.0	22	80

Note:

1. Test frequency : Inductor(L) : 10KHz /0.1V;
2. All test data referenced to 25°C ambient.
3. Testing Instrument : L/Q: Agilent-4192A, Agilent-16334A ; Irms:CH3302,CH1320 ; SRF: Agilent-4291B ; Rdc: Agilent-34420A
4. Rated Current (Irms) will cause the coil temperature rise approximately Δt of 20°C .

■ DC Bias Characteristics (Typical)

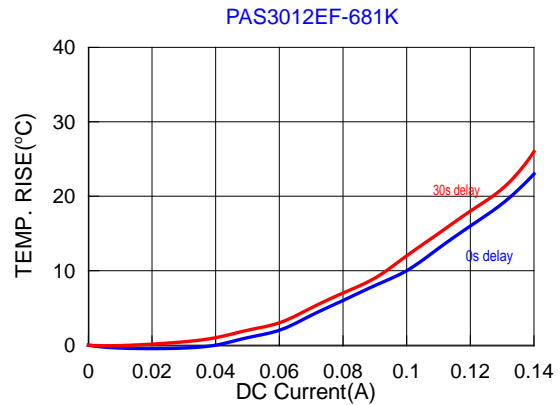
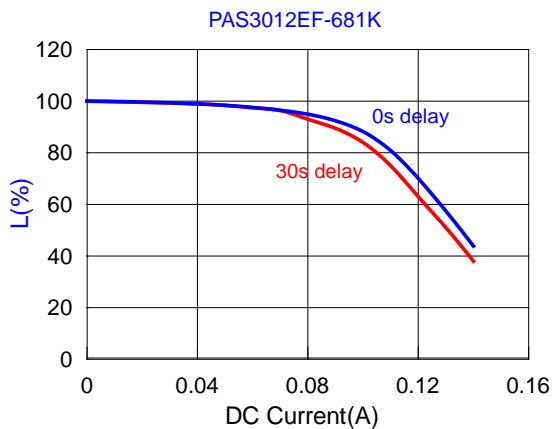



■ Dimensions

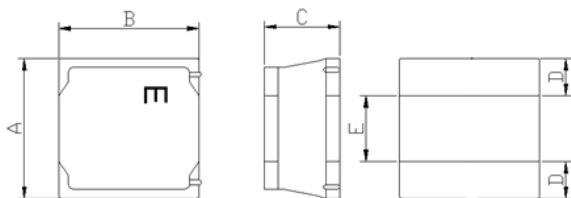

Dimensions	
A	3.00±0.20
B	3.00±0.20
C	1.50 max.
D	1.00 ref.
E	1.00 ref.

Units: mm

■ Specifications

Part Number	Inductance (uH)	Test Frequency (Hz)	SRF MHz (min)	RDC(Ω) Max.	Rated current (mA) Max.
PAS3015EF-122K	1200±10%	1V/10K	2.45	39.0	80

■ DC Bias Characteristics (Typical)

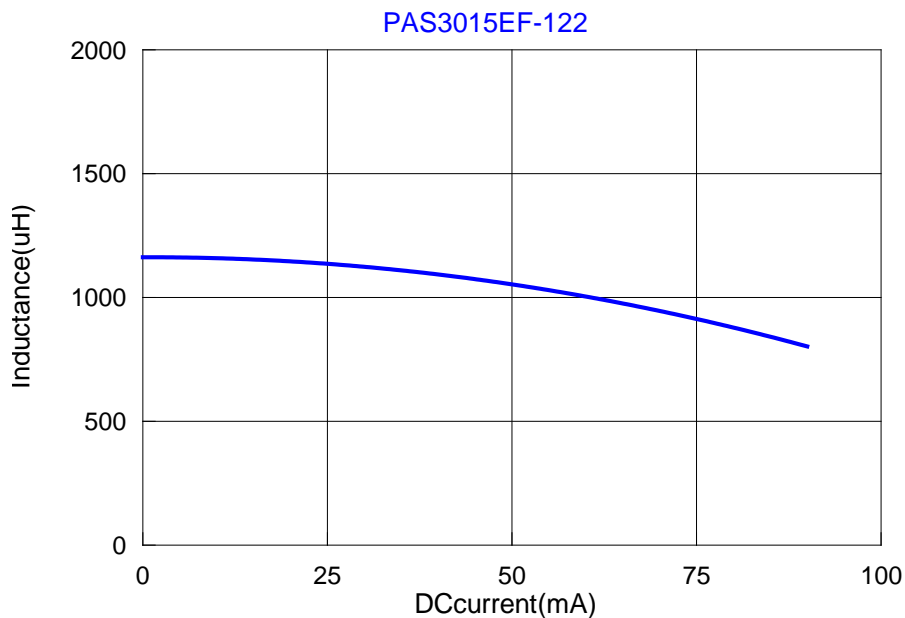



■ Dimensions

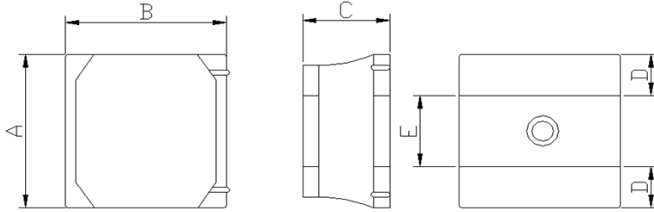

Dimensions	
A	4.00±0.20
B	4.00±0.20
C	1.80 max.
D	1.20 ref.
E	1.60 ref.

Units: mm

■ Specifications

Part Number	Inductance (uH)	Test Frequency (Hz)	SRF MHz (min)	RDC(Ω) Max.	Rated current (mA) Max.
PAS4018EF-102M	1000±20%	1V/100K	3.00	13.0	60

■ DC Bias Characteristics (Typical)

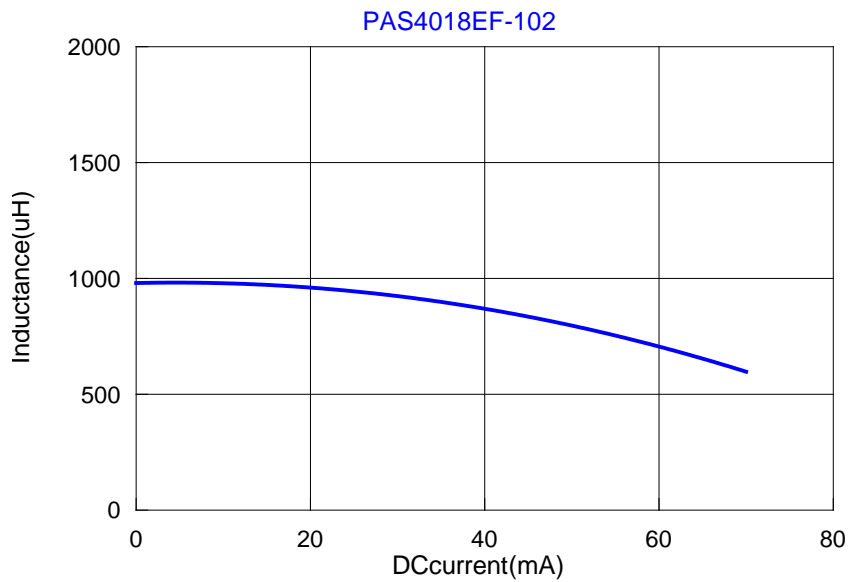



■ Dimensions

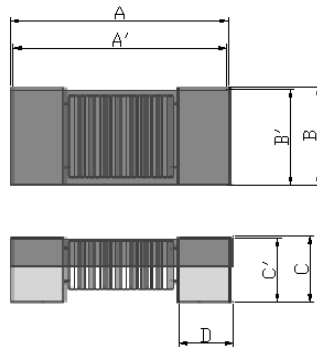

Chip Size	
A	4.55±0.25
A'	4.2±0.2
B	2.2±0.25
B'	1.80±0.2
C	2.0±0.2
C'	1.80±0.2
D	0.98 ref.

Units: mm

■ Specifications

Part Number	Inductance (uH) ±10%	f _{Lo} (kHz)	SRF MHz(min)	RDC (Ω) max.	Rated Current (mA) max.
PAS4420F-352K-F10-DS	3500	10	1.00	85	20
PAS4420F-492K-F10-DS	4900	10	0.65	109	20

Note:

1. Test frequency : Inductor(L) : 10KHz /0.1V;
2. All test data referenced to 25°C ambient.
3. Testing Instrument : L/Q: Agilent-4192A, Agilent-16334A ; Irms:CH3302,CH1320 ; SRF: Agilent-4291B ; Rdc: Agilent-34420A
4. Rated Current (Irms) will cause the coil temperature rise approximately Δt of 20°C .

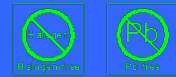

■ Dimensions

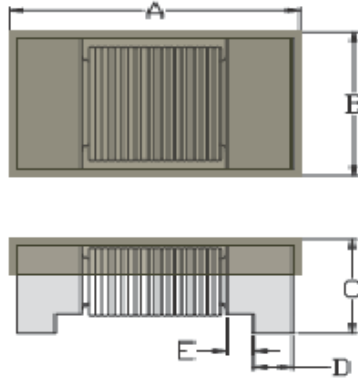

Chip Size	
A	6.40±0.30
B	2.30±0.20
C	1.80±0.20
D	0.90 ref.
E	0.50 ref.

Units: mm

■ Specifications

Part Number	Inductance (uH) ±10%	Test Frequency (KHz)	SRF Hz(min)	DC Resistance (Ω) ±10%	Rated Current (mA) max.
PAS6420F-701K-F10	700	10	2.45M	12	80
PAS6420F-532K-F10	5300	10	510K	66	30
PAS6420F-722K-F10	7200	10	450K	130	15

Note:

1. Test frequency : Inductor(L) : 10KHz /0.1V;
2. All test data referenced to 25°C ambient.
3. Testing Instrument : L/Q: Agilent-4192A, Agilent-16334A ; Irms:CH3302,CH1320 ; SRF: Agilent-4291B ; Rdc: Agilent-34420A
4. Rated Current (Irms) will cause the coil temperature rise approximately Δt of 20°C .

■ DC Bias Characteristics (Typical)

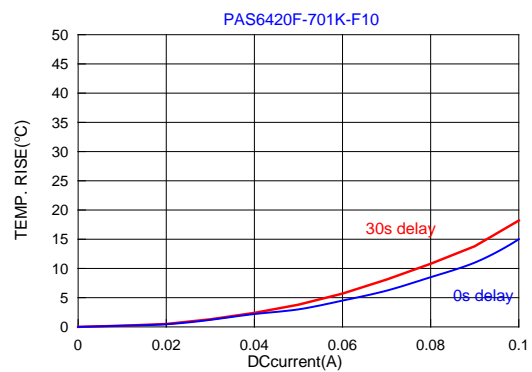
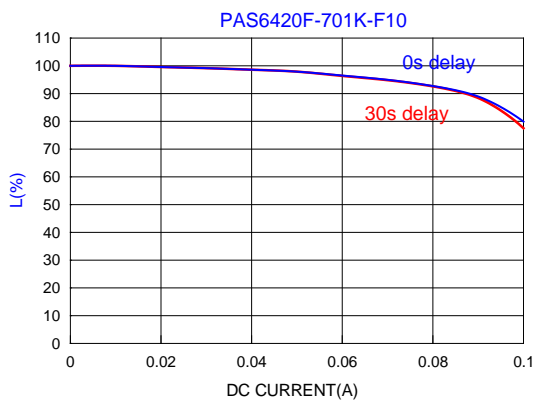



■ Dimensions

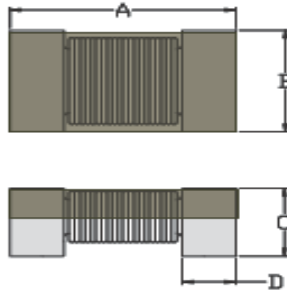

Dimensions	
A	7.85 max
B	2.70 max
C	2.70 max
D	1.15 ref.

Units: mm

■ Specifications

Part Number	Inductance (mH) ±5%	Test Frequency (Hz)	Q Typ.	RDC (Ω) max	Rated current (mA) max.
PAS8027F-452J	4.5	125K	30	80	20
PAS8027F-492J	4.9	125K	30	85	20
PAS8027F-722J	7.2	125K	35	105	20
PAS8027F-193J	18.52	125K	35	240	20

Note:

1. Test frequency : Inductor(L) : 125KHz /0.1V;
2. All test data referenced to 25°C ambient.
3. Testing Instrument : L/Q: Agilent-4192A, Agilent-16334A ; Irms:CH3302,CH1320 ; SRF: Agilent-4291B ; Rdc: Agilent-34420A
4. Rated Current (Irms) will cause the coil temperature rise approximately Δt of 20°C .



■ Dimensions

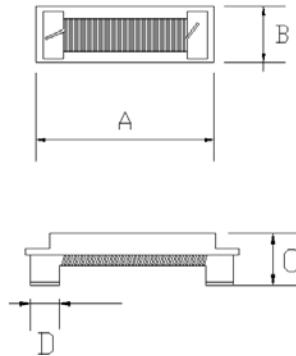

Chip Size	
A	11.60±0.30
B	3.80±0.30
C	2.50±0.30
D	1.50 ref.

Units: mm

■ Specifications

Part Number	Inductance (uH)	Test Frequency (Hz)	I rms (mA) max.	DC Resistance (Ω) max.	SRF (MHz) min.
PAS1225F-101K	100±10%	0.1V/125K	300	3.0	20
PAS1225F-232M	2300±20%	0.1V/125K	50	40	0.48
PAS1225F-492J	4900±5%	0.1V/125K	50	50	0.34
PAS1225F-722J	7200±5%	0.1V/125K	50	40	0.30

Note:

1. All test data referenced to 25°C ambient.
2. Testing Instrument : L/Q: Agilent-4192A, Agilent-16334A ; I rms: CH3302, CH1320 ; SRF: Agilent-4291B ; Rdc: Agilent-34420A
3. Rated Current (I rms) will cause the coil temperature rise approximately Δt of 20°C .



Power Inductors / Chokes

■ Multilayer Type Power Inductors

CPI Series	123
------------------	-----

■ Sealed Type Power Inductors

HPC Series	127
------------------	-----

UHP Series	143
------------------	-----

DFP Series	146
------------------	-----

AHP Series	150
------------------	-----

■ Power Inductors

FPI Series	164
------------------	-----

■ Assembly Type Power Inductors

FWP Series	173
------------------	-----

SDSL Series	174
-------------------	-----

TPRHC Series	177
--------------------	-----



■ Dimensions

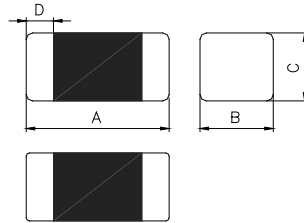

Dimensions	
A	1.60±0.15
B	0.80±0.15
C	0.80±0.15
D	0.30±0.20

Units: mm

■ Specifications

Tai-Tech Part Number	Inductance (uH)	Test Frequency (Hz)	Rated Current (mA) max.	DCR (Ω)	SRF (MHz) min.
CPI160808IF-R24M-1A2	0.24±20%	1M / 60mV	1200	0.10±25%	90
CPI160808IF-R47M-1A2	0.47±20%	1M / 60mV	1200	0.10±25%	70
CPI160808IF-1R0M-0A9	1.0±20%	1M / 60mV	950	0.20±25%	60
CPI160808IF-2R2M-0A7	2.2±20%	1M / 60mV	750	0.30±25%	50

- Rated current: specifies that self-heat generation is below 40°C during DC loaded
- In compliance with EIA 595.



■ Dimensions

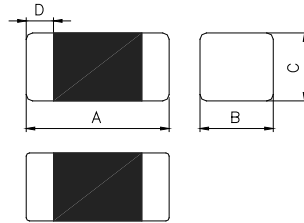

Dimensions	
A	2.00±0.20
B	1.25±0.20
C	1.00 max
D	0.50±0.30

Units: mm

■ Specifications

Tai-Tech Part Number	Inductance (uH)	Test Frequency (Hz)	Rated Current (mA) max.	DCR (Ω)	SRF (MHz) min.
CPI201210IF-R47M-1A2	0.47±20%	1M / 60mV	1200	0.075±25%	100
CPI201210IF-1R0M-0A9	1.0±20%	1M / 60mV	900	0.12±25%	50
CPI201210IF-2R2M-0A8	2.2±20%	1M / 60mV	800	0.17±25%	50
CPI201210IF-4R7M-0A7	4.7±20%	1M / 60mV	700	0.23±25%	40

- Rated current: specifies that self-heat generation is below 40°C during DC loaded
- In compliance with EIA 595.



■ Dimensions

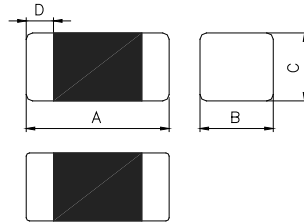

Dimensions	
A	2.00±0.20
B	1.60±0.20
C	1.00 max
D	0.50±0.30

Units: mm

■ Specifications

Tai-Tech Part Number	Inductance (uH)	Test Frequency (Hz)	Rated Current (mA) max.	DCR (Ω)	SRF (MHz) min.
CPI201610IF-R47M-1A6	0.47±20%	1M / 60mV	1600	0.06±25%	80
CPI201610IF-1R0M-1A3	1.0±20%	1M / 60mV	1300	0.10±25%	70
CPI201610IF-2R2M-1A1	2.2±20%	1M / 60mV	1100	0.12±25%	40
CPI201610IF-4R7M-0A9	4.7±20%	1M / 60mV	900	0.16±25%	20

- Rated current: specifies that self-heat generation is below 40°C during DC loaded
- In compliance with EIA 595.



■ Dimensions

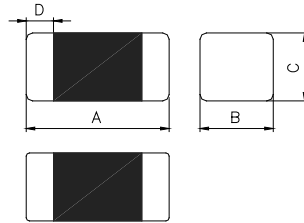

Dimensions	
A	2.50±0.20
B	2.00±0.20
C	1.00 max
D	0.50±0.30

Units: mm

■ Specifications

Tai-Tech Part Number	Inductance (uH)	Test Frequency (Hz)	Rated Current (mA) max.	DCR (Ω)	SRF (MHz) min.
CPI252010IF-1R0M-1A5	1.0±20%	1M / 60mV	1500	0.07±25%	60
CPI252010IF-1R5M-1A4	1.5±20%	1M / 60mV	1400	0.08±25%	50
CPI252010IF-2R2M-1A3	2.2±20%	1M / 60mV	1300	0.08±25%	40
CPI252010IF-3R3M-1A2	3.3±20%	1M / 60mV	1200	0.10±25%	30
CPI252010IF-4R7M-1A1	4.7±20%	1M / 60mV	1100	0.12±25%	25

- Rated current: specifies that self-heat generation is below 40°C during DC loaded
- In compliance with EIA 595.

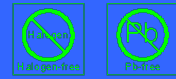

■ Dimensions

Chip Size	
A	2.50-0.10/+0.30
B	2.00-0.05/+0.35
C	0.80 max.
D	0.85 ref.
E	0.80 ref.

Units: mm

■ Specifications

Part Number	Inductance (uH)	Test Frequency (Hz)	DCR (Ω) typ.	DCR (Ω) Max.	I sat (A) typ.	I sat (A) Max.	I rms (A) typ.	I rms (A) Max.
HPC252008MF-R47	0.47±20%	0.1V/1M	0.080	0.096	2.50	2.20	1.45	1.25
HPC252008MF-R68	0.68±20%	0.1V/1M	0.100	0.120	2.05	1.80	1.35	1.15
HPC252008MF-1R0	1.0±20%	0.1V/1M	0.120	0.145	1.75	1.50	1.20	1.05
HPC252008MF-1R5	1.5±20%	0.1V/1M	0.170	0.200	1.65	1.45	1.05	0.95
HPC252008MF-2R2	2.2±20%	0.1V/1M	0.210	0.250	1.40	1.20	0.95	0.85
HPC252008MF-3R3	3.3±20%	0.1V/1M	0.300	0.360	1.10	0.95	0.85	0.75
HPC252008MF-4R7	4.7±20%	0.1V/1M	0.400	0.480	0.90	0.80	0.70	0.63
HPC252008MF-6R8	6.8±20%	0.1V/1M	0.670	0.800	0.75	0.65	0.55	0.50
HPC252008MF-100	10.0±20%	0.1V/1M	0.930	1.110	0.55	0.50	0.45	0.41

Note:

I_{sat} : Based on inductance change (ΔL/L0 : ≤-30%) @ ambient temp. 25°C

I_{rms} : Based on temperature rise (ΔT : 40°C) MAX

■ DC Bias Characteristics (Typical)

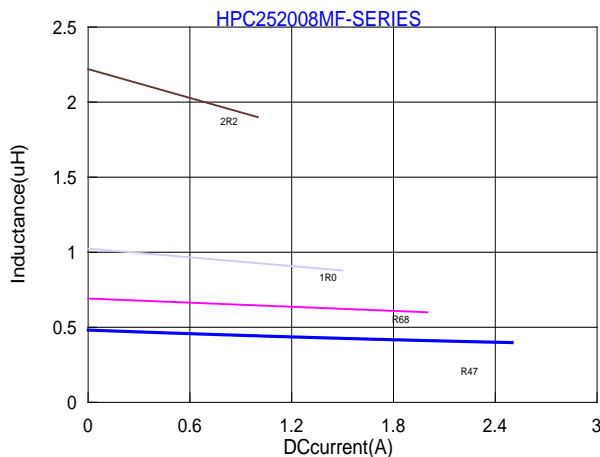

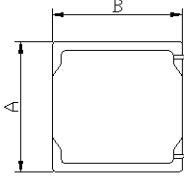
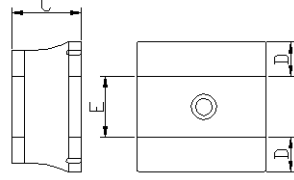

■ Dimensions

Chip Size	
A	3.00±0.20
B	3.00±0.20
C	1.00 max.
D	1.00 ref.
E	1.00 ref.

Units: mm

■ Specifications

Part Number	Inductance (uH)	Tolerance (%)	Test Frequency (Hz)	DCR (Ω) ±20%	I sat (A) typ.	I sat (A) max.	I rms (A) typ.	I rms (A) max.
HPC3010TF-1R0Y	1.0	±30%	0.1V/1M	0.055	2.20	1.80	2.50	2.10
HPC3010TF-1R5Y	1.5	±30%	0.1V/1M	0.070	2.00	1.50	2.20	1.90
HPC3010TF-2R2M	2.2	±20%	0.1V/1M	0.090	1.60	1.30	2.10	1.70
HPC3010TF-3R3M	3.3	±20%	0.1V/1M	0.130	1.30	1.10	1.70	1.50
HPC3010TF-4R7M	4.7	±20%	0.1V/1M	0.170	1.20	0.90	1.50	1.30
HPC3010TF-6R8M	6.8	±20%	0.1V/1M	0.260	0.90	0.77	1.30	1.00
HPC3010TF-100M	10	±20%	0.1V/1M	0.350	0.75	0.63	1.00	0.80
HPC3010TF-150M	15	±20%	0.1V/1M	0.510	0.65	0.54	0.80	0.70
HPC3010TF-220M	22	±20%	0.1V/1M	0.750	0.55	0.43	0.75	0.60

Note:

I_{sat} : Based on inductance change (ΔL/L0 : ≤-30%) @ ambient temp. 25°C
 I_{rms} : Based on temperature rise (ΔT : 40°C typ.)

■ DC Bias Characteristics (Typical)

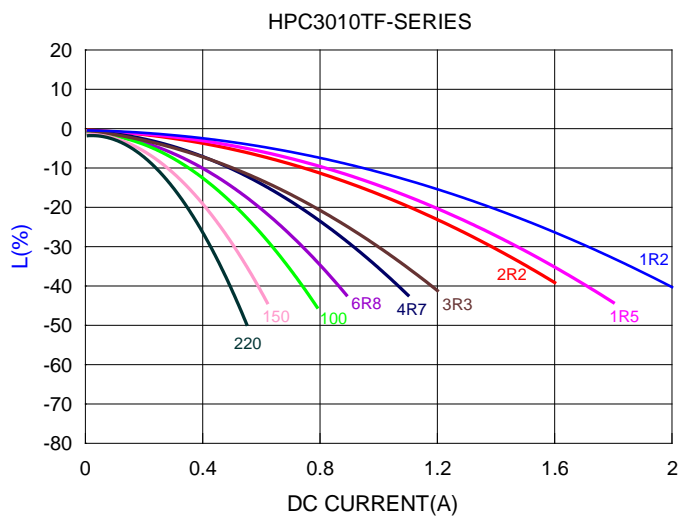

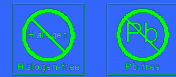

■ Dimensions

Chip Size	
A	3.00±0.20
B	3.00±0.20
C	1.20 max.
D	1.00 ref.
E	1.00 ref.

Units: mm

■ Specifications

Part Number	Inductance (uH)	Tolerance (%)	Test Frequency (Hz)	DCR (Ω) ±20%	I sat (A) typ.	I sat (A) max.	I rms (A) typ	I rms (A) max.
HPC3012TF-1R0Y	1.0	±30%	0.1V/1M	0.042	2.50	2.15	2.20	2.00
HPC3012TF-1R5Y	1.5	±30%	0.1V/1M	0.056	2.00	1.70	2.00	1.85
HPC3012TF-2R2M	2.2	±20%	0.1V/1M	0.080	1.80	1.50	1.90	1.70
HPC3012TF-3R3M	3.3	±20%	0.1V/1M	0.100	1.50	1.20	1.70	1.55
HPC3012TF-4R7M	4.7	±20%	0.1V/1M	0.130	1.30	1.05	1.50	1.30
HPC3012TF-6R8M	6.8	±20%	0.1V/1M	0.180	1.20	0.90	1.20	1.05
HPC3012TF-100M	10	±20%	0.1V/1M	0.245	0.90	0.76	1.00	0.89
HPC3012TF-150M	15	±20%	0.1V/1M	0.386	0.80	0.62	0.90	0.74
HPC3012TF-220M	22	±20%	0.1V/1M	0.580	0.60	0.49	0.70	0.61

Note:

I_{sat} : Based on inductance change (ΔL/L0 : ≤-30%) @ ambient temp. 25°C

I_{rms} : Based on temperature rise (ΔT : 40°C typ.)

■ DC Bias Characteristics (Typical)

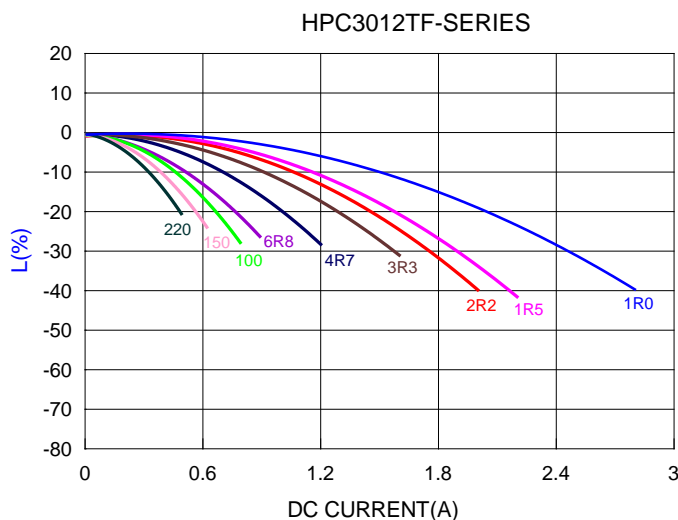

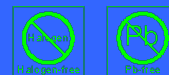

■ Dimensions

Chip Size	
A	3.00±0.20
B	3.00±0.20
C	1.50 max.
D	1.00 ref.
E	1.00 ref.

Units: mm

■ Specifications

Part Number	Inductance (uH)	Tolerance (%)	Test Frequency (Hz)	SRF (MHz) typ.	DCR (Ω) ±20%	I sat (A)typ	I sat (A)max.	I rms (A)typ	I rms (A)max.
HPC3015TF-1R0Y	1.0	±30%	1V100K	100	0.030	2.20	2.00	2.20	2.00
HPC3015TF-1R5Y	1.5	±30%	1V100K	87	0.040	2.00	1.80	2.00	1.80
HPC3015TF-2R2M	2.2	±20%	1V100K	64	0.060	1.70	1.50	1.70	1.50
HPC3015TF-3R3M	3.3	±20%	1V100K	49	0.080	1.40	1.20	1.40	1.20
HPC3015TF-4R7M	4.7	±20%	1V100K	40	0.120	1.20	1.00	1.20	1.00
HPC3015TF-6R8M	6.8	±20%	1V100K	36	0.160	1.00	0.90	1.00	0.90
HPC3015TF-100M	10	±20%	1V100K	28	0.220	0.75	0.65	0.80	0.70
HPC3015TF-150M	15	±20%	1V100K	23	0.320	0.65	0.55	0.70	0.60
HPC3015TF-220M	22	±20%	1V100K	20	0.460	0.55	0.45	0.60	0.50
HPC3015TF-330M	33	±20%	1V100K	18	0.800	0.40	0.35	0.45	0.40
HPC3015TF-470M	47	±20%	1V100K	17	1.200	0.35	0.30	0.40	0.35

Note:

I_{sat} : Based on inductance change (ΔL/L₀ : ≤-30%) @ ambient temp. 25°C

I_{rms} : Based on temperature rise (ΔT : 40°C typ.)

■ DC Bias Characteristics (Typical)

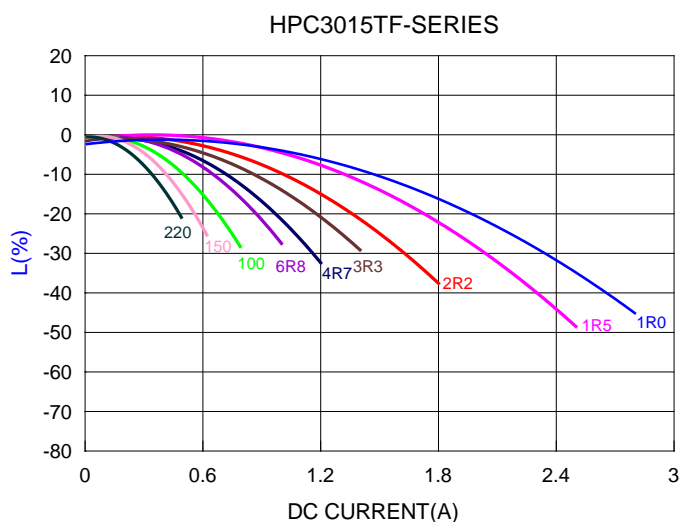

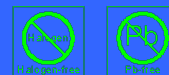

■ Dimensions

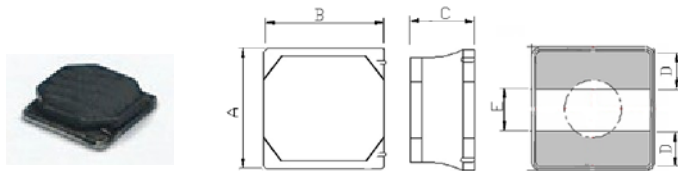

Chip Size	
A	4.00±0.20
B	4.00±0.20
C	1.00 max.
D	1.2 ref.
E	1.6 ref.

Units: mm

■ Specifications

Part Number	Inductance (uH)	Tolerance (%)	Test Frequency (Hz)	SRF (MHz) typ.	DCR (Ω) ±20%	I sat (A)typ.	I sat (A)Max.	I rms (A)typ.	I rms (A)Max.
HPC4010TF-1R0Y	1.0	±30%	1V100K	116	0.056	2.40	2.00	2.30	1.90
HPC4010TF-2R2M	2.2	±20%	1V100K	73	0.085	1.50	1.20	1.80	1.50
HPC4010TF-3R3M	3.3	±20%	1V100K	58	0.100	1.30	1.10	1.70	1.40
HPC4010TF-4R7M	4.7	±20%	1V100K	47	0.140	1.20	0.95	1.50	1.20
HPC4010TF-6R8M	6.8	±20%	1V100K	38	0.200	1.00	0.80	1.20	1.00
HPC4010TF-100M	10	±20%	1V100K	31	0.300	0.80	0.62	0.90	0.75
HPC4010TF-150M	15	±20%	1V100K	24	0.430	0.70	0.54	0.80	0.60
HPC4010TF-220M	22	±20%	1V100K	19	0.570	0.60	0.45	0.80	0.50

Note:

Isat : Based on inductance change ($\Delta L/L0 : \leq -30\%$) @ ambient temp. 25°C

Irms : Based on temperature rise ($\Delta T : 40^\circ\text{C}$ typ.)

■ DC Bias Characteristics (Typical)

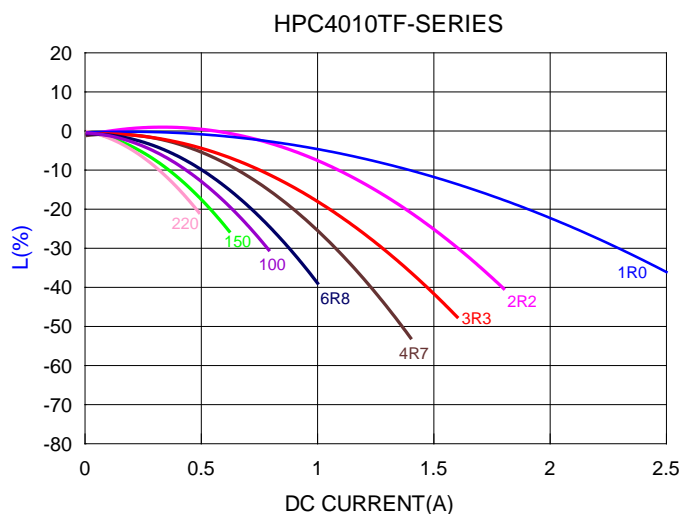

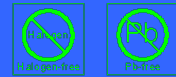

■ Dimensions

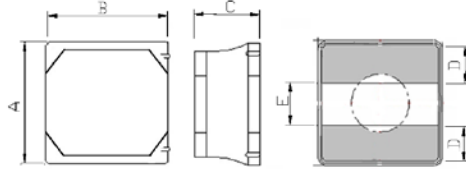

Chip Size	
A	4.00±0.20
B	4.00±0.20
C	1.20 max.
D	1.20 ref.
E	1.60 ref.

Units: mm

■ Specifications

Part Number	Inductance (uH)	Tolerance (%)	Test Frequency (Hz)	SRF (MHz) typ.	DCR (Ω) ±20%	I sat (A)typ.	I sat (A)Max.	I rms (A)typ.	I rms (A)Max.
HPC4012TF-1R0Y	1.0	±30%	1V100K	100	0.042	3.30	2.80	2.50	2.20
HPC4012TF-2R2M	2.2	±20%	1V100K	70	0.060	1.95	1.65	2.20	1.90
HPC4012TF-3R3M	3.3	±20%	1V100K	60	0.070	1.60	1.40	1.90	1.70
HPC4012TF-4R7M	4.7	±20%	1V100K	45	0.095	1.40	1.20	1.70	1.50
HPC4012TF-6R8M	6.8	±20%	1V100K	35	0.125	1.10	0.90	1.50	1.30
HPC4012TF-100M	10	±20%	1V100K	30	0.180	1.00	0.80	1.30	1.10
HPC4012TF-150M	15	±20%	1V100K	24	0.260	0.80	0.65	0.95	0.75
HPC4012TF-220M	22	±20%	1V100K	18	0.400	0.60	0.50	0.72	0.62

Note:

I_{sat} : Based on inductance change ($\Delta L/L_0 : \leq -30\%$) @ ambient temp. 25°C

I_{rms} : Based on temperature rise ($\Delta T : 40^\circ\text{C typ.}$)

■ DC Bias Characteristics (Typical)

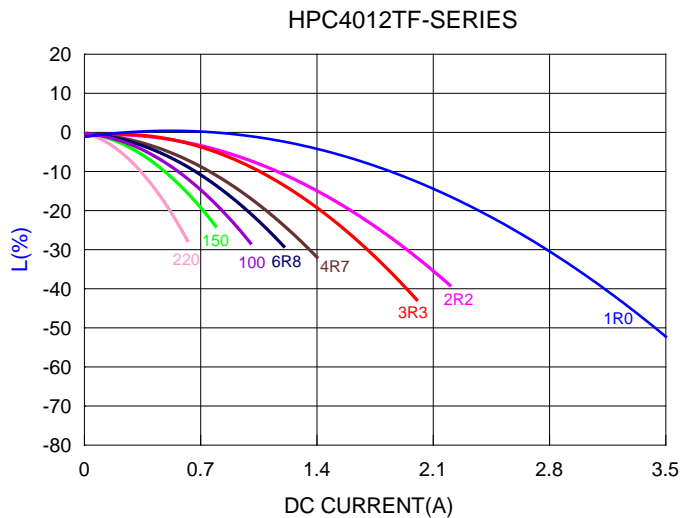

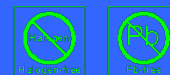

■ Dimensions

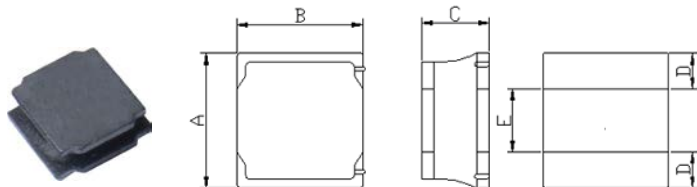

Chip Size	
A	4.00±0.20
B	4.00±0.20
C	1.80 max.
D	1.2 ref
E	1.6 ref

Units: mm

■ Specifications

Part Number	Inductance (uH)	Tolerance (%)	Test Frequency (Hz)	SRF (MHz) typ.	DCR (Ω) ±20%	I sat (A)typ.	I sat (A)Max.	I rms (A)typ.	I rms (A)Max.
HPC4018NF-1R0M	1	±20%	1V100K	160	0.027	4	3.6	3.7	3.6
HPC4018NF-1R5M	1.5	±20%	1V100K	110	0.032	3.3	3	3.3	3
HPC4018NF-2R2M	2.2	±20%	1V100K	70	0.042	3	2.7	2.9	2.7
HPC4018NF-3R3M	3.3	±20%	1V100K	60	0.055	2.3	2.2	2.3	2.2
HPC4018NF-4R7M	4.7	±20%	1V100K	50	0.07	2	1.9	2	1.9
HPC4018NF-6R8M	6.8	±20%	1V100K	40	0.098	1.7	1.6	1.7	1.6
HPC4018NF-100M	10	±20%	1V100K	35	0.15	1.5	1.4	1.5	1.4
HPC4018NF-150M	15	±20%	1V100K	25	0.19	1.1	1	1.1	1
HPC4018NF-220M	22	±20%	1V100K	20	0.29	0.9	0.8	0.9	0.8
HPC4018NF-330M	33	±20%	1V100K	12	0.405	0.75	0.7	0.75	0.7
HPC4018NF-470M	47	±20%	1V100K	10	0.55	0.6	0.55	0.6	0.55

Note:

I_{sat} : Based on inductance change (ΔL/L0 : ≤-30%) @ ambient temp. 25°C

I_{rms} : Based on temperature rise (ΔT : 40°C typ.)



■ Dimensions

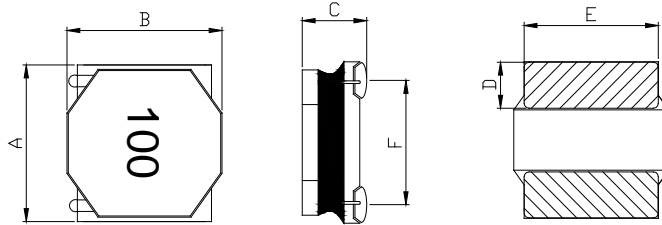

Dimensions	
A	5.00±0.20
B	5.00±0.20
C	1.80±0.20
D	1.30±0.20
E	4.70±0.20
F	3.70 ref.

Units: mm

■ Specifications

Part Number	Inductance (uH)	Tolerance	Rated current		DCR (mΩ) @25°C ±20%.
			Temperature current I rms (A)	Saturation current I sat (A)	
HPC5020NF-1R0Y	1.00	±30%	4.10	5.00	20
HPC5020NF-1R2Y	1.20	±30%	3.80	4.80	20
HPC5020NF-1R5Y	1.50	±30%	3.50	4.50	25
HPC5020NF-2R2M	2.20	±20%	3.30	4.10	32
HPC5020NF-2R7M	2.70	±20%	3.00	3.80	38
HPC5020NF-3R3M	3.30	±20%	2.80	3.50	43
HPC5020NF-4R7M	4.70	±20%	2.40	2.70	60
HPC5020NF-5R6M	5.60	±20%	2.10	2.40	69
HPC5020NF-6R8M	6.80	±20%	1.90	2.10	90
HPC5020NF-8R2M	8.20	±20%	1.75	1.90	98
HPC5020NF-100M	10.0	±20%	1.60	1.70	110
HPC5020NF-120M	12.0	±20%	1.40	1.40	135
HPC5020NF-150M	15.0	±20%	1.25	1.30	165
HPC5020NF-180M	18.0	±20%	1.17	1.20	190
HPC5020NF-220M	22.0	±20%	1.10	1.10	225
HPC5020NF-330M	33.0	±20%	0.80	0.80	335
HPC5020NF-470M	47.0	±20%	0.70	0.70	460

Note:

1. All test data referenced to 25°C ambient, Ls:100KHz/1V.
2. Heat Rated Current (I_{rms}) will cause the coil temperature rise approximately Δt of 40°C
3. Saturation Current (I_{sat}) will cause L₀ to drop approximately 30%

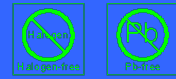

DC Bias Characteristics (Typical)

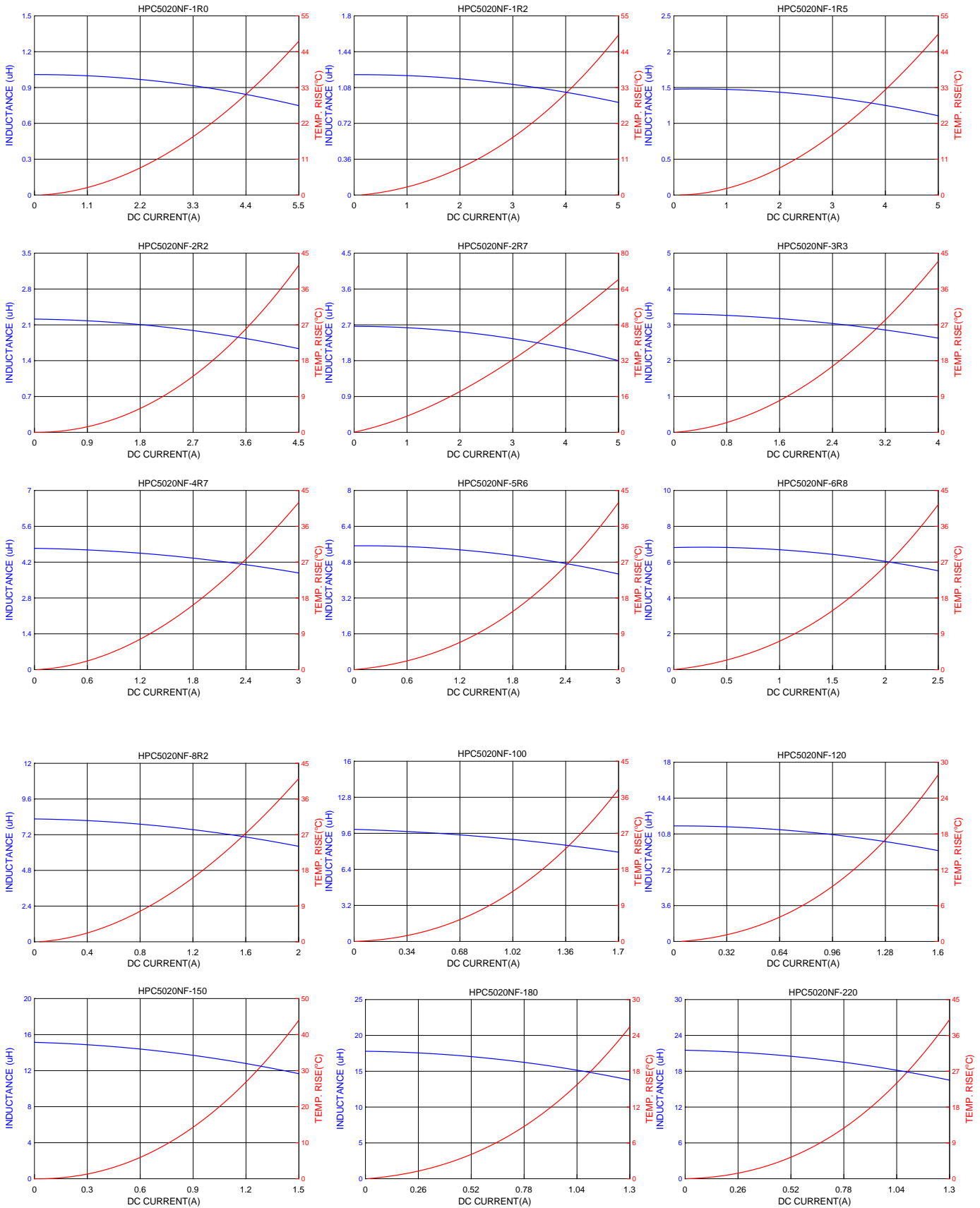



■ Dimensions

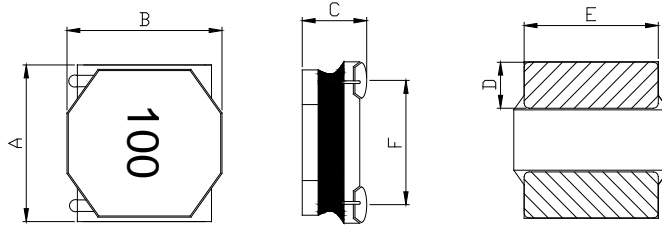

Dimensions	
A	4.95±0.20
B	4.95±0.20
C	*1. 3.90±0.20 *2. 3.80±0.20
D	1.30±0.30
E	4.20±0.20
F	3.70 ref.

Units: mm

*1 ≤ 10 uH

*2 > 10 uH

■ Specifications

Part Number	Inductance (uH)	Tolerance				Rated current		DCR (mΩ) @25°C ±20%.
		K	L	M	Y	Temperature current I rms (A)	Saturation current I sat (A)	
HPC5040NF-1R5	1.50	/	/	±20%	±30%	4.50	6.50	15
HPC5040NF-2R2	2.20	/	/	±20%	±30%	3.80	5.70	21
HPC5040NF-3R3	3.30	/	/	±20%	±30%	3.50	4.40	24
HPC5040NF-4R7	4.70	/	/	±20%	±30%	3.20	3.90	32
HPC5040NF-6R8	6.80	/	/	±20%	±30%	2.50	3.30	43
HPC5040NF-100	10.0	/	/	±20%	±30%	2.20	2.52	56
HPC5040NF-150	15.0	/	±15%	±20%	±30%	1.80	2.00	80
HPC5040NF-220	22.0	/	±15%	±20%	±30%	1.50	1.62	123
HPC5040NF-330	33.0	/	±15%	±20%	±30%	1.20	1.30	180
HPC5040NF-470	47.0	±10%	±15%	±20%	±30%	1.00	1.10	270
HPC5040NF-680	68.0	±10%	±15%	±20%	±30%	0.80	0.90	400
HPC5040NF-101	100	±10%	±15%	±20%	±30%	0.72	0.75	560

Note:

1. All test data referenced to 25°C ambient, Ls:100KHz/1V.
2. Heat Rated Current (I_{rms}) will cause the coil temperature rise approximately Δt of 40°C
3. Saturation Current (I_{sat}) will cause L₀ to drop approximately 30%



DC Bias Characteristics (Typical)

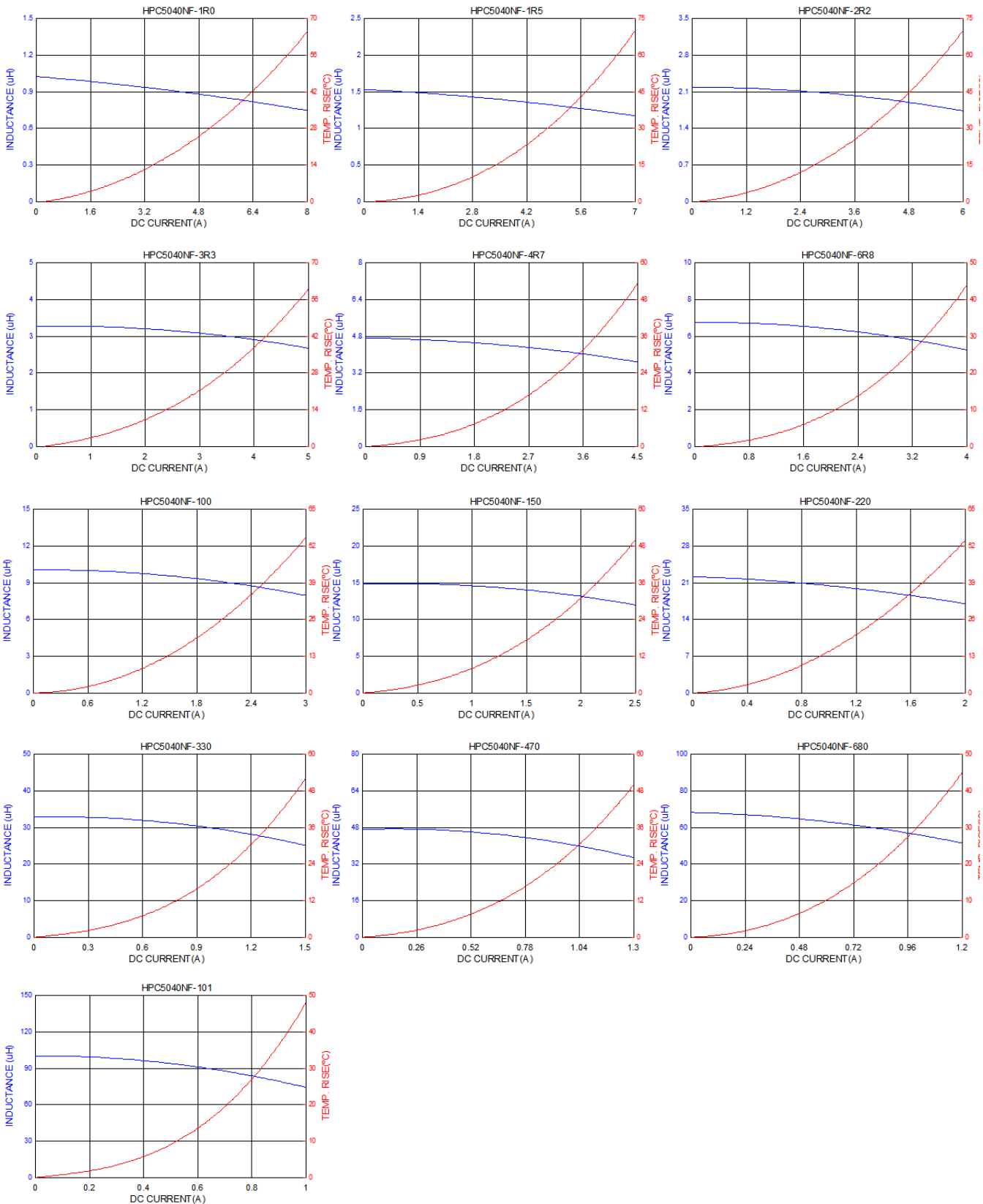

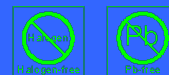

■ Dimensions

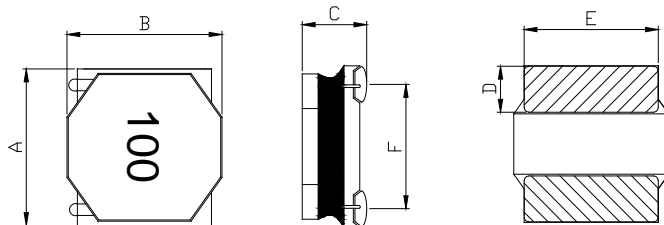

Dimensions	
A	6.00±0.20
B	6.00±0.20
C	1.80±0.20
D	1.60±0.30
E	5.80±0.30
F	4.30 ref.

Units: mm

■ Specifications

Part Number	Inductance (uH)	Tolerance				Rated current		DCR (mΩ)@25°C ±20%.
						Temperature current I rms (A)	Saturation current I sat (A)	
		K	L	M	Y			
HPC6020NF-1R0	1.00	/	/	±20%	±30%	4.5	6.2	19
HPC6020NF-1R5	1.50	/	/	±20%	±30%	3.8	5.5	22.5
HPC6020NF-2R0	2.00	/	/	±20%	±30%	3.65	5.3	25
HPC6020NF-2R2	2.20	/	/	±20%	±30%	3.5	5	29
HPC6020NF-3R3	3.30	/	/	±20%	±30%	3.3	4	35
HPC6020NF-4R7	4.70	/	±15%	±20%	±30%	2.8	3	54
HPC6020NF-5R6	5.60	/	±15%	±20%	±30%	2.6	2.7	59
HPC6020NF-6R8	6.80	/	±15%	±20%	±30%	2.5	2.6	78
HPC6020NF-8R2	8.20	/	±15%	±20%	±30%	2.3	2.4	103
HPC6020NF-100	10.0	±10%	±15%	±20%	±30%	2.1	2.1	106
HPC6020NF-150	15.0	±10%	±15%	±20%	±30%	1.6	1.5	138
HPC6020NF-220	22.0	±10%	±15%	±20%	±30%	1.4	1.3	204

Note:

1. All test data referenced to 25°C ambient , Ls:100KHz/1V.
2. Heat Rated Current (I_{rms}) will cause the coil temperature rise approximately Δt of 40°C
3. Saturation Current (I_{sat}) will cause L₀ to drop approximately 30%

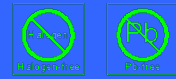

DC Bias Characteristics (Typical)

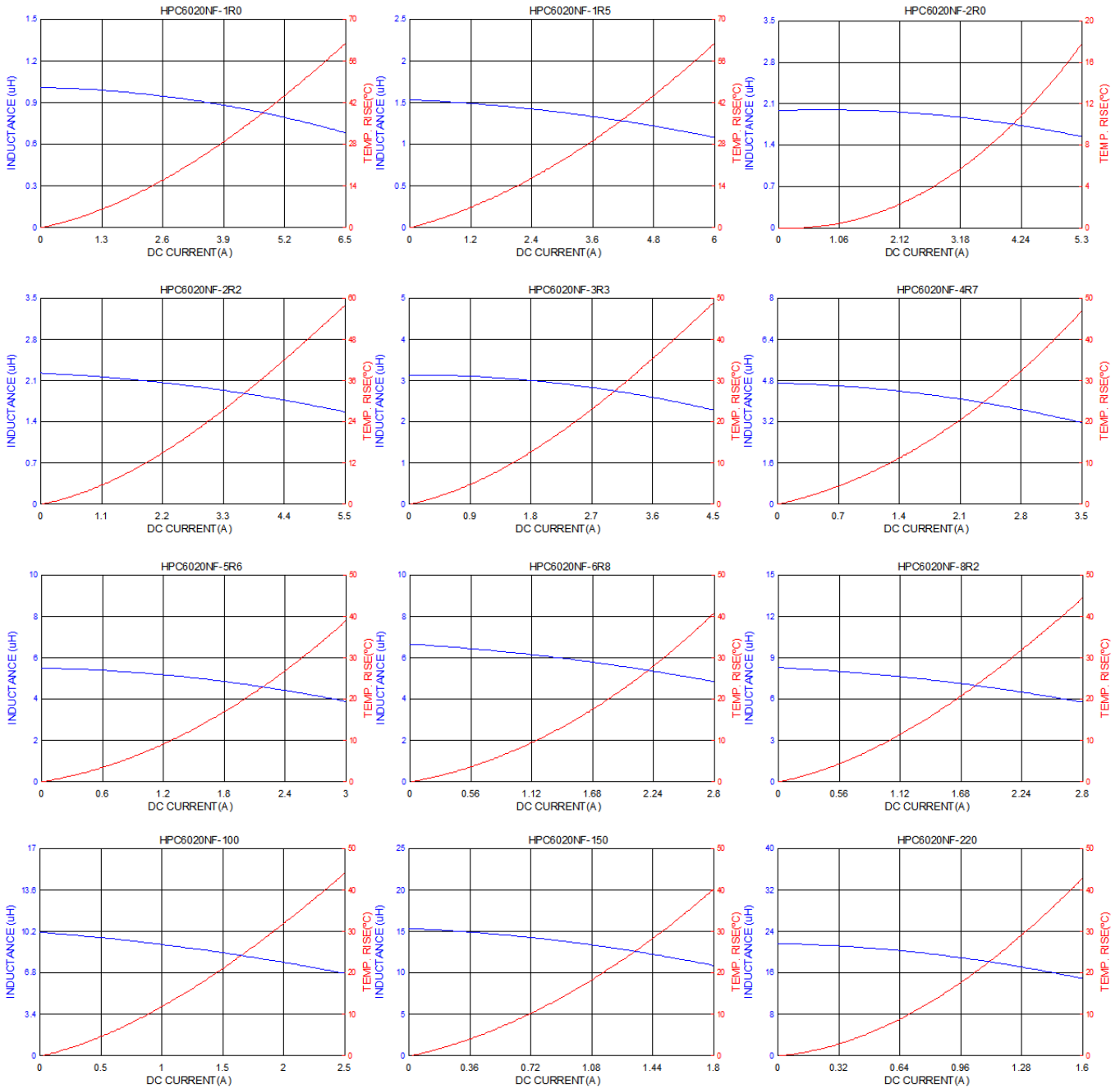



■ Dimensions

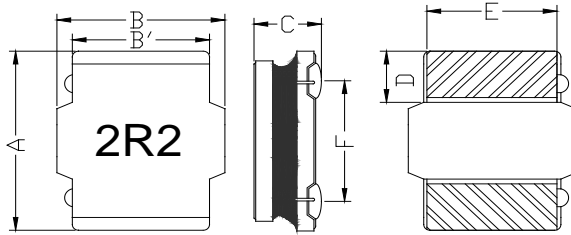

Dimensions		unit: mm
A	6.00±0.20	
B	6.00±0.20	
B'	4.80±0.20	
C	4.20±0.30	
D	1.70±0.30	
E	4.50±0.30	
F	4.25±0.30	

■ Specifications

Part Number	Inductance L ₀ (uH) @ 0 A	Tolerance				Rated current				DCR (mΩ) @25°C ±20%.
						Temperature current I _{rms} (A)		Saturation current I _{sat} (A)		
		K	L	M	Y	Typ	Max	Typ	Max	
HPC6045NF-R36	0.36	/	/	±20%	±30%	9.00	8.50	18.00	16.50	4.80
HPC6045NF-R47	0.47	/	/	±20%	±30%	8.60	8.00	17.00	16.00	6.80
HPC6045NF-R82	0.82	/	/	±20%	±30%	8.20	7.50	14.50	13.50	8.50
HPC6045NF-1R0	1.00	/	/	±20%	±30%	8.00	7.30	13.50	12.50	10.0
HPC6045NF-1R2	1.20	/	/	±20%	±30%	7.50	7.00	12.50	11.50	10.5
HPC6045NF-1R3	1.30	/	/	±20%	±30%	7.50	7.00	12.50	11.50	10.5
HPC6045NF-1R5	1.50	/	/	±20%	±30%	7.00	6.60	12.00	11.00	11.7
HPC6045NF-1R8	1.80	/	/	±20%	±30%	6.80	6.20	11.00	10.00	12.0
HPC6045NF-2R0	2.00	/	/	±20%	±30%	6.50	5.80	10.50	9.50	13.5
HPC6045NF-2R2	2.20	/	/	±20%	±30%	6.00	5.30	9.50	8.55	15.0
HPC6045NF-2R3	2.30	/	/	±20%	±30%	5.80	5.00	9.30	8.20	16.0
HPC6045NF-3R0	3.00	/	/	±20%	±30%	5.20	4.60	8.00	7.50	20.0
HPC6045NF-3R3	3.30	/	/	±20%	±30%	5.00	4.50	7.80	7.30	21.0
HPC6045NF-3R6	3.60	/	/	±20%	±30%	4.90	4.30	7.40	6.90	22.5
HPC6045NF-4R7	4.70	/	±15%	±20%	±30%	4.50	4.00	6.80	6.20	26.0
HPC6045NF-5R6	5.60	/	±15%	±20%	±30%	4.10	3.70	6.40	5.70	31.0
HPC6045NF-6R3	6.30	/	±15%	±20%	±30%	3.80	3.50	5.90	5.30	33.0
HPC6045NF-6R8	6.80	/	±15%	±20%	±30%	3.60	3.30	5.70	5.15	34.0
HPC6045NF-8R2	8.20	/	±15%	±20%	±30%	3.40	2.90	5.10	4.50	46.0
HPC6045NF-100	10.0	±10%	±15%	±20%	±30%	3.20	2.60	4.60	4.20	52.0
HPC6045NF-150	15.0	±10%	±15%	±20%	±30%	2.80	2.20	3.80	3.30	71.0
HPC6045NF-180	18.0	±10%	±15%	±20%	±30%	2.60	2.10	3.40	2.90	80.0
HPC6045NF-220	22.0	±10%	±15%	±20%	±30%	2.30	1.90	3.30	2.70	96.0

Note:

1. All test data referenced to 25°C ambient, L_s:1MHz/1V.
2. Heat Rated Current (I_{rms}) will cause the coil temperature rise approximately Δt of 40°C.
3. Saturation Current (I_{sat}) will cause L₀ to drop approximately 30%.

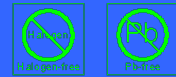

Part Number	Inductance (uH)	Tolerance				Rated current				DCR (mΩ) @25°C ±20%
						Temperature current I rms (A)		Saturation current I sat (A)		
		K	L	M	Y	Typ	Max	Typ	Max	
HPC6045NF-330	33.0	±10%	±15%	±20%	±30%	1.80	1.50	2.50	2.10	145
HPC6045NF-470	47.0	±10%	±15%	±20%	±30%	1.60	1.20	2.00	1.75	200
HPC6045NF-560	56.0	±10%	±15%	±20%	±30%	1.40	1.00	1.80	1.65	230
HPC6045NF-680	68.0	±10%	±15%	±20%	±30%	1.10	0.92	1.60	1.52	305
HPC6045NF-820	82.0	±10%	±15%	±20%	±30%	0.98	0.88	1.50	1.40	365
HPC6045NF-101	100	±10%	±15%	±20%	±30%	0.92	0.82	1.33	1.25	456
HPC6045NF-121	120	±10%	±15%	±20%	±30%	0.85	0.79	1.20	1.10	500
HPC6045NF-151	150	±10%	±15%	±20%	±30%	0.75	0.70	1.10	1.00	626
HPC6045NF-181	180	±10%	±15%	±20%	±30%	0.68	0.60	1.00	0.90	745
HPC6045NF-221	220	±10%	±15%	±20%	±30%	0.60	0.50	0.88	0.77	900
HPC6045NF-331	330	±10%	±15%	±20%	±30%	0.55	0.45	0.60	0.55	1400
HPC6045NF-471	470	±10%	±15%	±20%	±30%	0.40	0.35	0.50	0.45	2050

Note:

1. Heat Rated Current (I rms) will cause the coil temperature rise approximately Δt of 40°C
2. Saturation Current (I sat) will cause L0 to drop approximately 30%

■ DC Bias Characteristics (Typical)

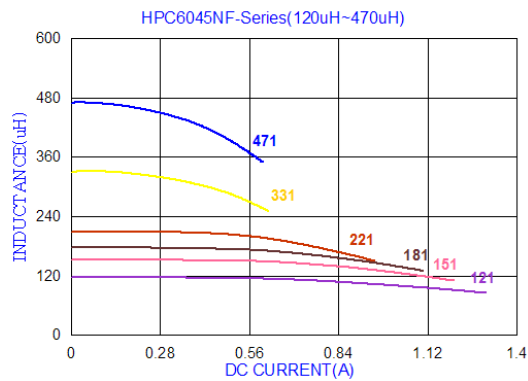
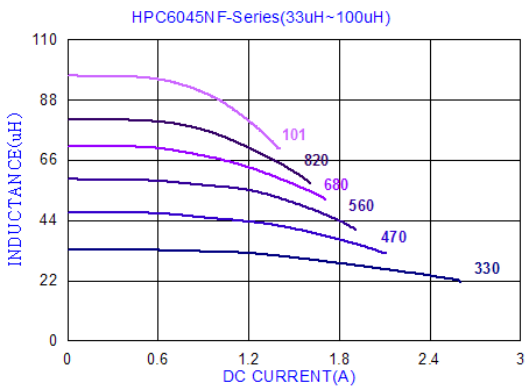
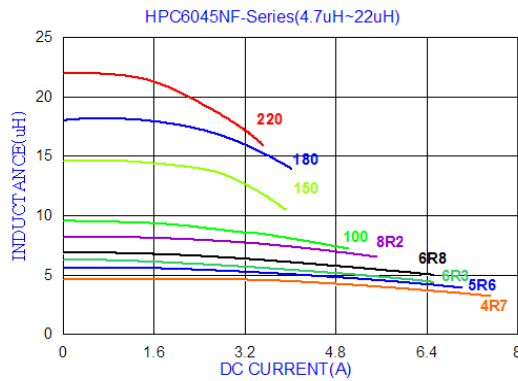
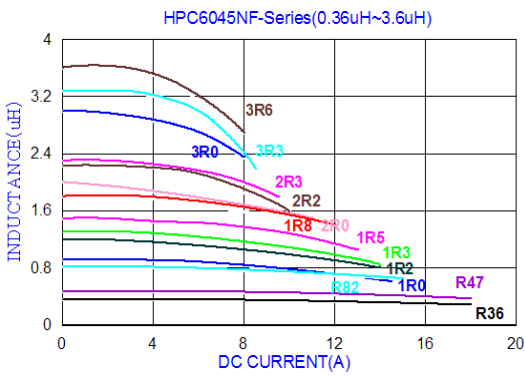



■ Dimensions

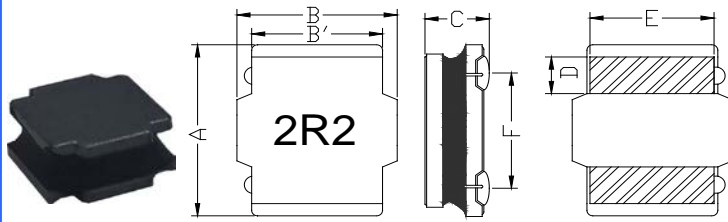

Chip Size	
A	8.00±0.30
B	8.00±0.30
B'	6.30±0.20
C	*1 3.90±0.30 *2 3.70±0.30
D	2.00±0.30
E	6.00±0.30
F	5.50±0.40

Units: mm

*1 1R0~100 Type
*2 150~471 Type

■ Specifications

Part Number	Inductance L ₀ (uH) @ 0 A	Tolerance				Frequency	Rated current				DCR (mΩ) @25°C ±20%.
							Temperature current I _{rms} (A)		Saturation current I _{sat} (A)		
		K	L	M	Y		Typ	Max	Typ	Max	
HPC8040NF-1R0□-Z01	1.00	/	/	±20%	±30%	1MHz/1V	8.50	8.00	13.80	13.00	8.2
HPC8040NF-1R5□-Z01	1.50	/	/	±20%	±30%	1MHz/1V	8.00	7.70	11.50	11.00	10.0
HPC8040NF-2R2□-Z01	2.20	/	/	±20%	±30%	1MHz/1V	7.40	6.90	9.80	9.20	11.5
HPC8040NF-3R3□-Z01	3.30	/	/	±20%	±30%	1MHz/1V	6.60	6.20	8.00	7.50	15.0
HPC8040NF-4R7□-Z01	4.70	/	±15%	±20%	±30%	1MHz/1V	5.80	5.30	6.70	6.00	19.5
HPC8040NF-5R6□-Z01	5.60	/	±15%	±20%	±30%	1MHz/1V	5.40	5.20	6.20	5.80	22.0
HPC8040NF-6R8□-Z01	6.80	/	±15%	±20%	±30%	1MHz/1V	5.10	5.00	5.60	5.10	25.0
HPC8040NF-8R2□-Z01	8.20	/	±15%	±20%	±30%	1MHz/1V	4.80	4.50	5.30	4.60	30.0
HPC8040NF-100□-Z01	10.0	±10%	±15%	±20%	±30%	1MHz/1V	4.60	4.20	5.00	4.30	33.0
HPC8040NF-150□-Z01	15.0	±10%	±15%	±20%	±30%	1MHz/1V	3.60	3.20	4.00	3.60	50.0
HPC8040NF-220□-Z01	22.0	±10%	±15%	±20%	±30%	1MHz/1V	2.90	2.45	3.10	2.80	73.0
HPC8040NF-330□-Z01	33.0	±10%	±15%	±20%	±30%	1MHz/1V	2.30	2.10	2.60	2.10	100
HPC8040NF-470□-Z01	47.0	±10%	±15%	±20%	±30%	1MHz/1V	2.00	1.70	2.20	1.90	135
HPC8040NF-560□-Z01	56.0	±10%	±15%	±20%	±30%	1MHz/1V	1.75	1.60	1.90	1.60	160
HPC8040NF-680□-Z01	68.0	±10%	±15%	±20%	±30%	1MHz/1V	1.65	1.50	1.75	1.50	205
HPC8040NF-820□-Z01	82.0	±10%	±15%	±20%	±30%	1MHz/1V	1.40	1.30	1.60	1.40	230
HPC8040NF-101□-Z01	100	±10%	±15%	±20%	±30%	1MHz/1V	1.20	1.10	1.45	1.20	300
HPC8040NF-121□-Z01	120	±10%	±15%	±20%	±30%	1MHz/1V	1.10	1.00	1.30	1.10	350
HPC8040NF-151□-Z01	150	±10%	±15%	±20%	±30%	1MHz/1V	0.98	0.90	1.20	1.03	410
HPC8040NF-181□-Z01	180	±10%	±15%	±20%	±30%	1MHz/1V	0.91	0.83	1.04	0.94	490
HPC8040NF-221□-Z01	220	±10%	±15%	±20%	±30%	1MHz/1V	0.85	0.76	0.99	0.90	610
HPC8040NF-331□-Z01	330	±10%	±15%	±20%	±30%	100KHz/1V	0.70	0.66	0.75	0.70	850
HPC8040NF-471□-Z01	470	±10%	±15%	±20%	±30%	100KHz/1V	0.63	0.58	0.60	0.55	1300

Note:

- All test data referenced to 25°C ambient, L_s:1MHz/1V.
- Heat Rated Current (I_{rms}) will cause the coil temperature rise approximately Δt of 40°C.
- Saturation Current (I_{sat}) will cause L₀ to drop approximately 30%.



■ Dimensions

Chip Size	
A	2.00-0.10/+0.20
B	1.60-0.10/+0.20
C	1.00 max.
D	0.60 ref.
E	0.80 ref.

Units: mm

■ Specifications

Part Number	Inductance (uH)	Test Frequency (Hz)	DCR (Ω) ±20%	I sat (A) typ.	I sat (A) Max.	I rms (A) typ.	I rms (A) Max.
UHP201610NF-R47Y	0.47±30%	0.1V/1M	0.044	3.00	2.70	2.60	2.35
UHP201610NF-R68Y	0.68±30%	0.1V/1M	0.062	2.45	2.00	2.25	2.05
UHP201610NF-1R0Y	1.0±30%	0.1V/1M	0.080	1.95	1.80	1.75	1.60
UHP201610NF-1R5Y	1.5±30%	0.1V/1M	0.130	1.65	1.46	1.40	1.26
UHP201610NF-2R2M	2.2±20%	0.1V/1M	0.145	1.45	1.26	1.35	1.20
UHP201610NF-3R3M	3.3±20%	0.1V/1M	0.245	1.05	0.90	1.05	0.95
UHP201610NF-4R7M	4.7±20%	0.1V/1M	0.360	0.85	0.77	1.00	0.90
UHP201610NF-6R8M	6.8±20%	0.1V/1M	0.500	0.80	0.72	0.70	0.55
UHP201610NF-100M	10±20%	0.1V/1M	0.720	0.62	0.55	0.50	0.45
UHP201610NF-150M	15±20%	0.1V/1M	1.400	0.50	0.45	0.40	0.36
UHP201610NF-180M	18±20%	0.1V/1M	1.800	0.45	0.40	0.38	0.34
UHP201610NF-220M	22±20%	0.1V/1M	2.000	0.43	0.38	0.30	0.27

Note:

I_{sat} : Based on inductance change (ΔL/L0 : ≤-30%) @ ambient temp. 25°C

I_{rms} : Based on temperature rise (ΔT : 40°C.)

■ DC Bias Characteristics (Typical)

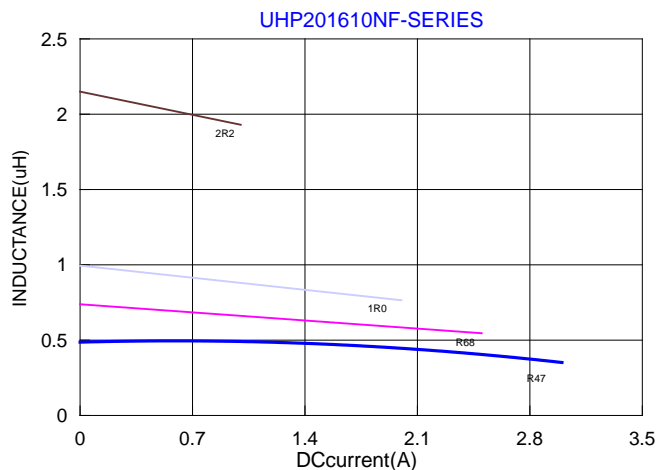

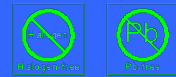

■ Dimensions

Chip Size	
A	2.50-0.10/+0.20
B	2.00-0.10/+0.20
C	1.00 max.
D	0.85 ref.
E	0.80 ref.

Units: mm

■ Specifications

Part Number	Inductance (uH)	Test Frequency (Hz)	DCR (Ω) ±20%	I sat (A) typ.	I sat (A) Max.	I rms (A) typ	I rms (A) Max.
UHP252010BF-R47Y	0.47±30%	0.1V/1M	0.030	2.85	2.57	2.80	2.50
UHP252010BF-R68Y	0.68±30%	0.1V/1M	0.039	2.70	2.45	2.45	2.20
UHP252010BF-1R0Y	1.0±30%	0.1V/1M	0.055	2.45	2.05	2.20	1.80
UHP252010BF-1R5Y	1.5±30%	0.1V/1M	0.090	1.80	1.70	1.70	1.55
UHP252010BF-2R2M	2.2±20%	0.1V/1M	0.114	1.60	1.55	1.55	1.40
UHP252010BF-3R3M	3.3±20%	0.1V/1M	0.170	1.30	1.10	1.25	1.10
UHP252010BF-4R7M	4.7±20%	0.1V/1M	0.250	1.10	0.95	1.05	0.92
UHP252010BF-6R8M	6.8±20%	0.1V/1M	0.370	0.95	0.80	0.85	0.76
UHP252010BF-100M	10±20%	0.1V/1M	0.470	0.75	0.65	0.75	0.67
UHP252010BF-150M	15±20%	0.1V/1M	0.750	0.55	0.45	0.55	0.50
UHP252010BF-220M	22±20%	0.1V/1M	1.120	0.50	0.40	0.50	0.45

Note:

I_{sat} : Based on inductance change (ΔL/L0 : ≤-30%) @ ambient temp. 25°C

I_{rms} : Based on temperature rise (ΔT : 40°C.) Max

■ DC Bias Characteristics (Typical)

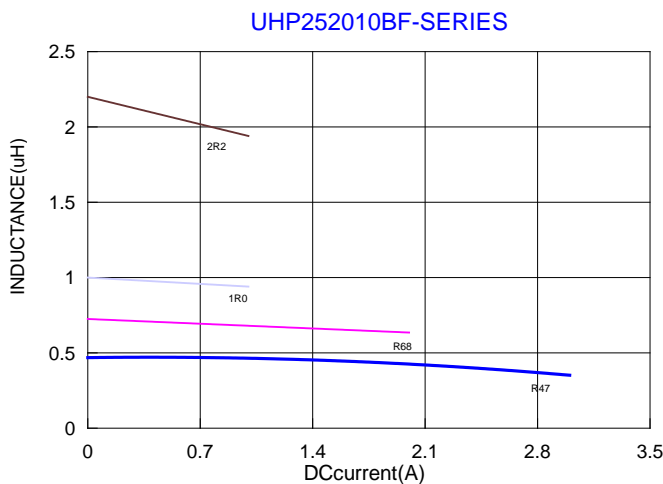

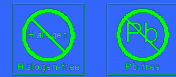

■ Dimensions

Chip Size	
A	2.50 -0.10/+0.20
B	2.00 -0.10/+0.20
C	1.20 max.
D	0.85 ref.
E	0.80 ref.

Units: mm

■ Specifications

Part Number	Inductance (uH)	Test Frequency (Hz)	DCR (Ω) ±20%	I sat (A) typ.	I sat (A) Max.	I rms (A) typ	I rms (A) Max.
UHP252012BF-R47Y	0.47±30%	0.1V/1M	0.028	4.00	3.60	3.70	3.35
UHP252012BF-R68Y	0.68±30%	0.1V/1M	0.036	3.00	2.70	3.30	3.00
UHP252012BF-1R0Y	1.0±30%	0.1V/1M	0.049	2.70	2.45	2.60	2.30
UHP252012BF-1R5Y	1.5±30%	0.1V/1M	0.063	2.30	2.05	2.20	1.95
UHP252012BF-2R2M	2.2±20%	0.1V/1M	0.080	2.15	1.95	1.85	1.65
UHP252012BF-3R3M	3.3±20%	0.1V/1M	0.120	1.70	1.50	1.45	1.30
UHP252012BF-4R7M	4.7±20%	0.1V/1M	0.176	1.50	1.35	1.20	1.05
UHP252012BF-6R8M	6.8±20%	0.1V/1M	0.250	1.15	1.00	1.00	0.90
UHP252012BF-100M	10±20%	0.1V/1M	0.410	0.85	0.75	0.75	0.65
UHP252012BF-150M	15±20%	0.1V/1M	0.540	0.63	0.56	0.60	0.54
UHP252012BF-220M	22±20%	0.1V/1M	0.850	0.56	0.50	0.50	0.45

Note:

I_{sat} : Based on inductance change (ΔL/L0 : ≤-30%) @ ambient temp. 25°C

I_{rms} : Based on temperature rise (ΔT : 40°C.) Max

■ DC Bias Characteristics (Typical)

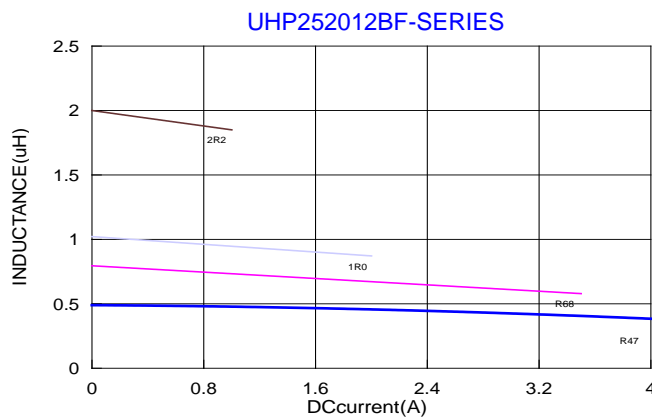

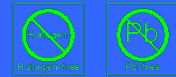

■ Dimensions

Chip Size	
A	2.00-0.10/+0.20
B	1.60-0.10/+0.20
C	1.00 max.
D	0.60 ref.
E	0.80 ref.

Units: mm

■ Specifications

Part Number	Inductance (uH)	Tolerance (%)	Test Frequency (Hz)	DCR (Ω) typ.	DCR (Ω) Max.	I sat (A) typ.	I sat (A) Max.	I rms (A) typ.	I rms (A) Max.
DFP201610TF-R24M	0.24	±20%	0.1V/1M	0.023	0.028	5.10	4.50	4.40	3.90
DFP201610TF-R33M	0.33	±20%	0.1V/1M	0.031	0.040	3.90	3.50	3.50	3.10
DFP201610TF-R47M	0.47	±20%	0.1V/1M	0.035	0.042	3.85	3.40	3.30	3.00
DFP201610TF-R68M	0.68	±20%	0.1V/1M	0.046	0.055	3.25	2.80	2.80	2.50
DFP201610TF-1R0M	1.0	±20%	0.1V/1M	0.059	0.072	2.90	2.50	2.40	2.20
DFP201610TF-1R5M	1.5	±20%	0.1V/1M	0.098	0.118	2.30	1.80	2.10	1.80
DFP201610TF-2R2M	2.2	±20%	0.1V/1M	0.141	0.170	2.10	1.70	1.70	1.55

Note:

I_{sat} : Based on inductance change (ΔL/L₀ : ≤-30%) @ ambient temp. 25°C

I_{rms} : Based on temperature rise (ΔT : 40°C.) Max

■ DC Bias Characteristics (Typical)

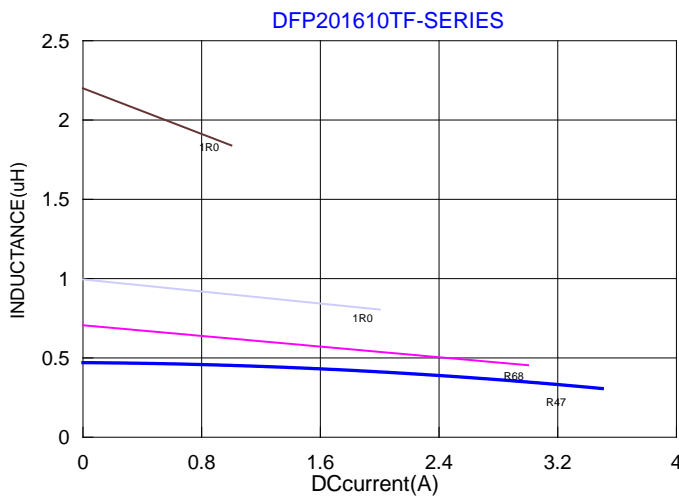

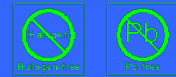

■ Dimensions

Chip Size	
A	2.00-0.10/+0.20
B	1.60-0.10/+0.20
C	1.20 max.
D	0.60 ref.
E	0.80 ref.

Units: mm

■ Specifications

Part Number	Inductance (uH)	Test Frequency (Hz)	DCR (Ω) typ.	DCR (Ω) Max.	I sat (A) typ.	I sat (A) Max.	I rms (A) typ	I rms (A) Max.
DFP201612NF-R24M	0.24±20%	0.1V/1M	0.025	0.033	5.40	4.80	4.00	3.50
DFP201612NF-R33M	0.33±20%	0.1V/1M	0.027	0.034	4.70	3.90	3.90	3.20
DFP201612NF-R47M	0.47±20%	0.1V/1M	0.035	0.046	3.90	3.50	3.30	2.90
DFP201612NF-R68M	0.68±20%	0.1V/1M	0.055	0.066	3.30	2.80	3.00	2.60
DFP201612NF-1R0M	1.0±20%	0.1V/1M	0.080	0.104	3.00	2.50	2.70	2.30
DFP201612NF-1R5M	1.5±20%	0.1V/1M	0.090	0.108	2.50	2.00	2.10	1.80
DFP201612NF-2R2M	2.2±20%	0.1V/1M	0.155	0.186	2.00	1.60	1.50	1.30

Note:

I_{sat} : Based on inductance change (ΔL/L0 : ≤-30%) @ ambient temp. 25°C

I_{rms} : Based on temperature rise (ΔT : 40°C.) Max

■ DC Bias Characteristics (Typical)

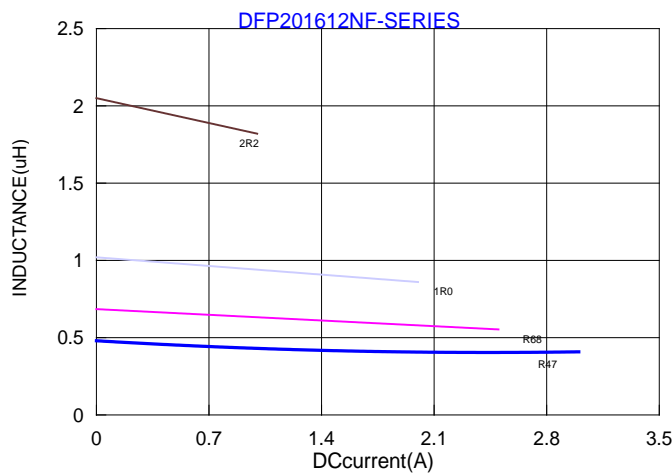

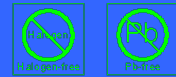

■ Dimensions

Chip Size	
A	2.50 -0.10/+0.20
B	2.00 -0.05/+0.35
C	1.00 max.
D	0.85 ref.
E	0.80 ref.

Units: mm

■ Specifications

Part Number	Inductance (uH)	Test Frequency (Hz)	DCR (Ω) typ.	DCR (Ω) Max.	I sat (A) typ.	I sat (A) Max.	I rms (A) typ	I rms (A) Max.
DFP252010NF-R24M	0.24±20%	0.1V/1M	0.030	0.042	4.80	4.30	3.60	3.10
DFP252010NF-R33M	0.33±20%	0.1V/1M	0.032	0.044	4.30	3.80	3.50	3.00
DFP252010NF-R47M	0.47±20%	0.1V/1M	0.034	0.046	4.00	3.30	3.40	2.90
DFP252010NF-R56M	0.56±20%	0.1V/1M	0.045	0.054	3.80	3.00	3.30	2.80
DFP252010NF-R68M	0.68±20%	0.1V/1M	0.046	0.055	3.70	2.90	3.30	2.80
DFP252010NF-1R0M	1.0±20%	0.1V/1M	0.060	0.080	3.40	2.70	2.60	2.20
DFP252010NF-1R2M	1.2±20%	0.1V/1M	0.090	0.108	2.90	2.30	2.30	1.90
DFP252010NF-1R5M	1.5±20%	0.1V/1M	0.090	0.108	2.70	2.10	2.30	1.90
DFP252010NF-2R2M	2.2±20%	0.1V/1M	0.130	0.169	2.40	1.90	1.80	1.50

Note:

Isat : Based on inductance change ($\Delta L/L0 : \leq -30\%$) @ ambient temp. 25°C

Irms : Based on temperature rise ($\Delta T : 40^{\circ}C.$) Max

■ DC Bias Characteristics (Typical)

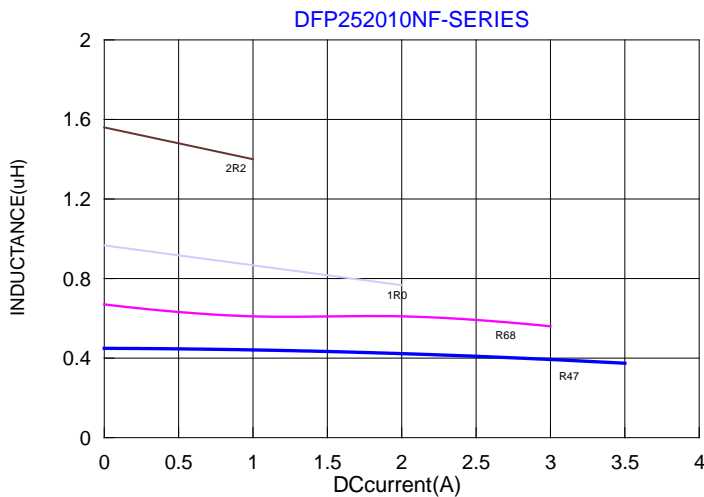

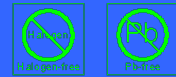

■ Dimensions

Chip Size	
A	2.50 -0.10/+0.20
B	2.00 -0.05/+0.35
C	1.20 max.
D	0.85 ref.
E	0.80 ref.

Units: mm

■ Specifications

Part Number	Inductance (uH)	Tolerance (%)	Test Frequency (Hz)	DCR (Ω) typ.	DCR (Ω) Max.	I sat (A) typ.	I sat (A) Max.	I rms (A) typ
DFP252012TF-R24M	0.24	±20%	0.1V/1M	0.024	0.028	8.00	6.50	4.70
DFP252012TF-R33M	0.33	±20%	0.1V/1M	0.027	0.032	5.70	4.60	4.50
DFP252012TF-R47M	0.47	±20%	0.1V/1M	0.027	0.032	5.50	4.50	4.40
DFP252012TF-R68M	0.68	±20%	0.1V/1M	0.036	0.043	4.50	3.80	3.60
DFP252012TF-1R0M	1.0	±20%	0.1V/1M	0.045	0.057	3.90	3.40	3.50
DFP252012TF-1R5M	1.5	±20%	0.1V/1M	0.080	0.096	3.00	2.60	2.50
DFP252012TF-2R2M	2.2	±20%	0.1V/1M	0.085	0.102	2.70	2.30	2.30

Note:

I_{sat} : Based on inductance change (ΔL/L0 : ≤-30%) @ ambient temp. 25°C
 I_{rms} : Based on temperature rise (ΔT : 40°C.) Max

■ DC Bias Characteristics (Typical)

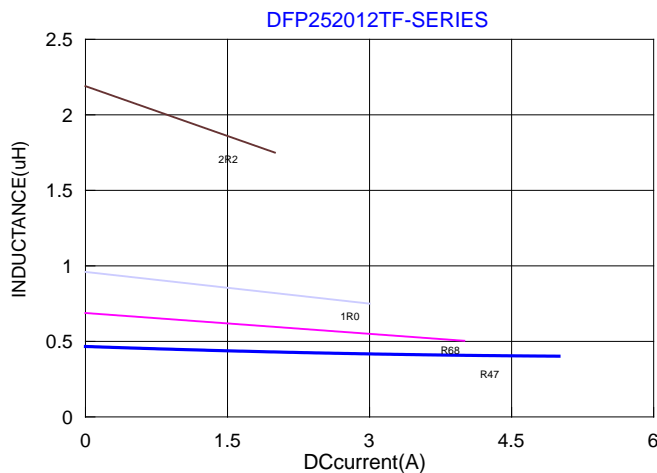



■ Dimensions

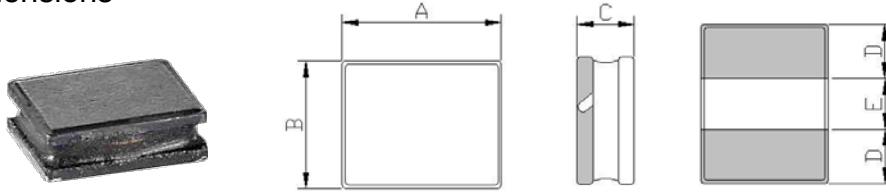

Series	A(mm)	B(mm)	C(mm)	D(mm)	E(mm)
AHP201610FA	2.0 -0.1/+0.2	1.6 -0.1/+0.2	1.0Max	0.50 ref.	1.00 ref.

Units: mm

■ Specifications

TAI-TECH Part Number	Inductance (uH)	Tolerance (%)	Test Frequency (Hz)	DCR (Ω) typ.	DCR (Ω) Max.	I sat (A) typ.	I sat (A) Max.	I rms (A) typ.	I rms (A) MAX
AHP201610FA-R24M	0.24	±20	1V/1M	0.015	0.020	7.50	6.50	5.70 (1) 6.50 (2)	5.10 (1) 5.50 (2)
AHP201610FA-R33M	0.33	±20	1V/1M	0.018	0.023	5.50	5.00	5.50 (1) 5.60 (2)	5.00 (1) 5.20 (2)
AHP201610FA-R47M	0.47	±20	1V/1M	0.024	0.029	5.20	4.50	4.70 (1) 5.30 (2)	4.30 (1) 4.70 (2)
AHP201610FA-R68M	0.68	±20	1V/1M	0.036	0.044	5.10	4.40	3.90 (1) 4.20 (2)	3.50 (1) 3.80 (2)
AHP201610FA-1R0M	1.0	±20	1V/1M	0.050	0.060	4.50	4.00	3.20 (1) 3.40 (2)	2.90 (1) 3.10 (2)
AHP201610FA-1R5M	1.5	±20	1V/1M	0.068	0.082	3.20	2.80	2.90 (1) 3.10 (2)	2.50 (1) 2.70 (2)
AHP201610FA-2R2M	2.2	±20	1V/1M	0.100	0.120	2.70	2.40	2.20 (1) 2.30 (2)	2.00 (1) 2.10 (2)
AHP201610FA-4R7M	4.7	±20	1V/1M	0.180	0.216	1.60	1.40	1.60 (1) 1.80 (2)	1.40 (1) 1.60 (2)

Note:

I_{sat} : Based on inductance change (ΔL/L0 : ≤30%) @ ambient temp. 25°C

I_{rms} : Based on temperature rise (ΔT : 40°C.) Max

Measurement board data

I_{rms1}

Material : FR4

Board dimensions : 100 X 50 X 1.6t mm

Pattern dimensions: 45 X 30 mm (Double side board)

Pattern thickness : 50 μm

I_{rms2}

Material: FR4

Board dimensions : 100 X 50 X 1.6t mm

Pattern dimensions: 45 X 45 mm (Double side board)

Pattern thickness : 70 μm



■ DC Bias Characteristics (Typical)

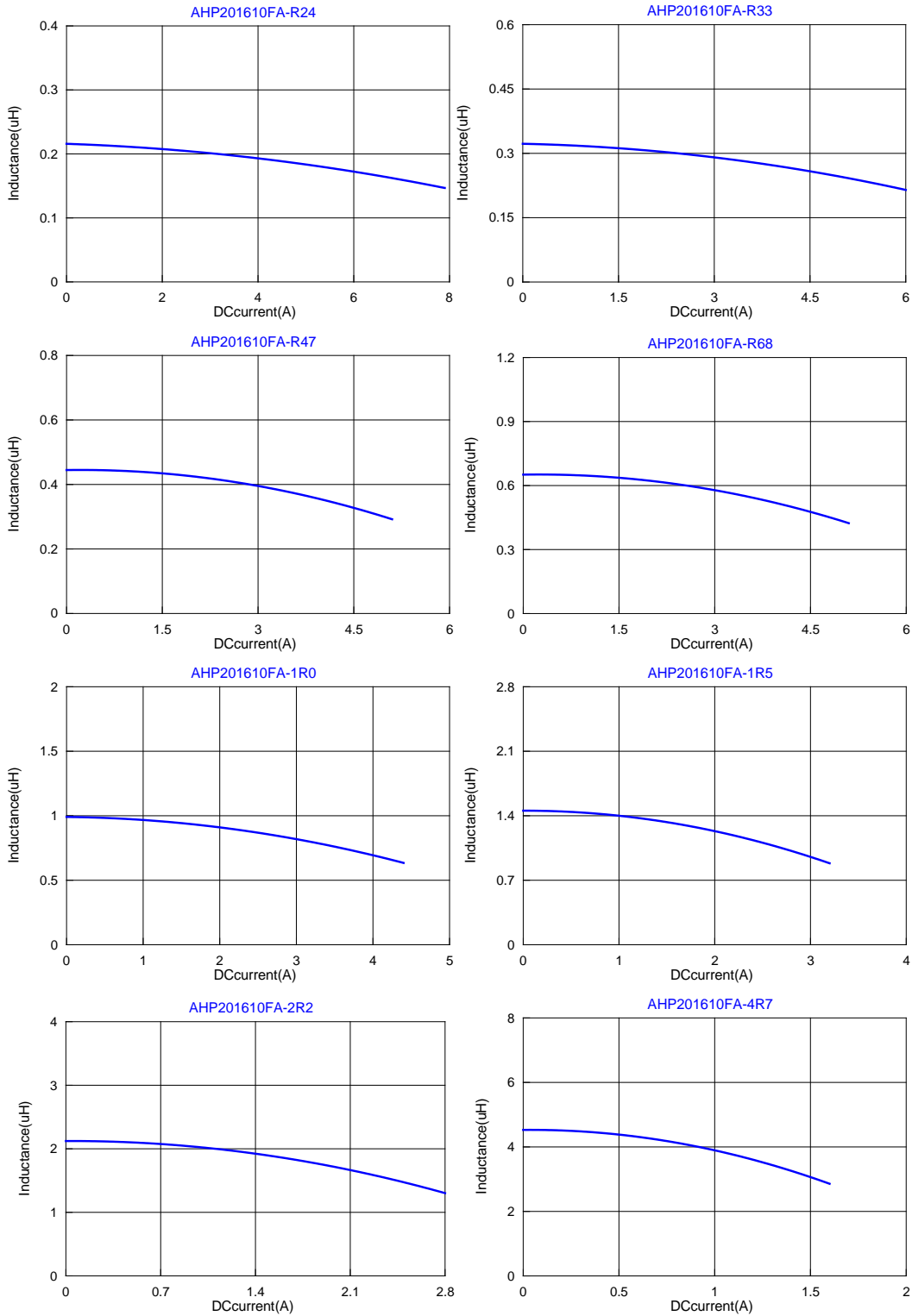



■ Dimensions

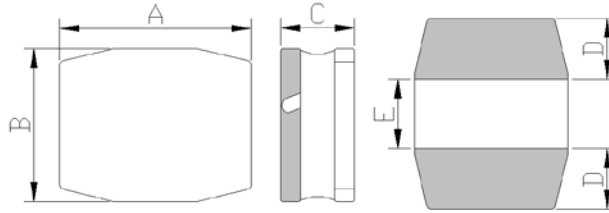

Series	A(mm)	B(mm)	C(mm)	D(mm)	E(mm)
AHP201610HF	2.0 -0.1/+0.2	1.6 -0.1/+0.2	1.0Max	0.50 ref.	1.00 ref.

Units: mm

■ Specifications

TAI-TECH Part Number	Inductance (uH)	Tolerance (%)	Test Frequency (Hz)	DCR (Ω) typ.	DCR (Ω) Max.	I sat (A) typ.	I sat (A) Max.	I rms (A) typ	I rms (A) MAX
AHP201610HF-R24M	0.24	±20	1V/1M	0.017	0.021	7.00	6.00	5.60 (1) 5.90 (2)	5.00 (1) 5.30 (2)
AHP201610HF-R33M	0.33	±20	1V/1M	0.023	0.029	5.50	5.00	5.10 (1) 5.30 (2)	4.60 (1) 4.80 (2)
AHP201610HF-R47M	0.47	±20	1V/1M	0.028	0.035	5.20	4.30	4.50 (1) 4.80 (2)	4.00 (1) 4.40 (2)
AHP201610HF-R68M	0.68	±20	1V/1M	0.040	0.050	4.30	3.70	3.80 (1) 4.00 (2)	3.40 (1) 3.60 (2)
AHP201610HF-1R0M	1.0	±20	1V/1M	0.053	0.065	3.60	3.00	3.10 (1) 3.50 (2)	2.80 (1) 3.20 (2)
AHP201610HF-1R5M	1.5	±20	1V/1M	0.100	0.120	2.60	2.30	2.40 (1) 2.70 (2)	2.10 (1) 2.30 (2)
AHP201610HF-2R2M	2.2	±20	1V/1M	0.110	0.130	2.10	1.90	2.10 (1) 2.20 (2)	1.90 (1) 2.00 (2)
AHP201610HF-4R7M	4.7	±20	1V/1M	0.190	0.230	1.10	1.00	1.10 (1) 1.20 (2)	1.00 (1) 1.10 (2)

Note:

I_{sat} : Based on inductance change (ΔL/L₀ : ≤30%) @ ambient temp. 25°C

I_{rms} : Based on temperature rise (ΔT : 40°C.) Max

Measurement board data

I_{rms1}

Material : FR4

Board dimensions : 100 X 50 X 1.6t mm

Pattern dimensions: 45 X 30 mm (Double side board)

Pattern thickness : 50 μm

I_{rms2}

Material: FR4

Board dimensions : 100 X 50 X 1.6t mm

Pattern dimensions: 45 X 45 mm (Double side board)

Pattern thickness : 70 μm

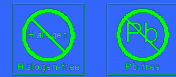

■ DC Bias Characteristics (Typical)

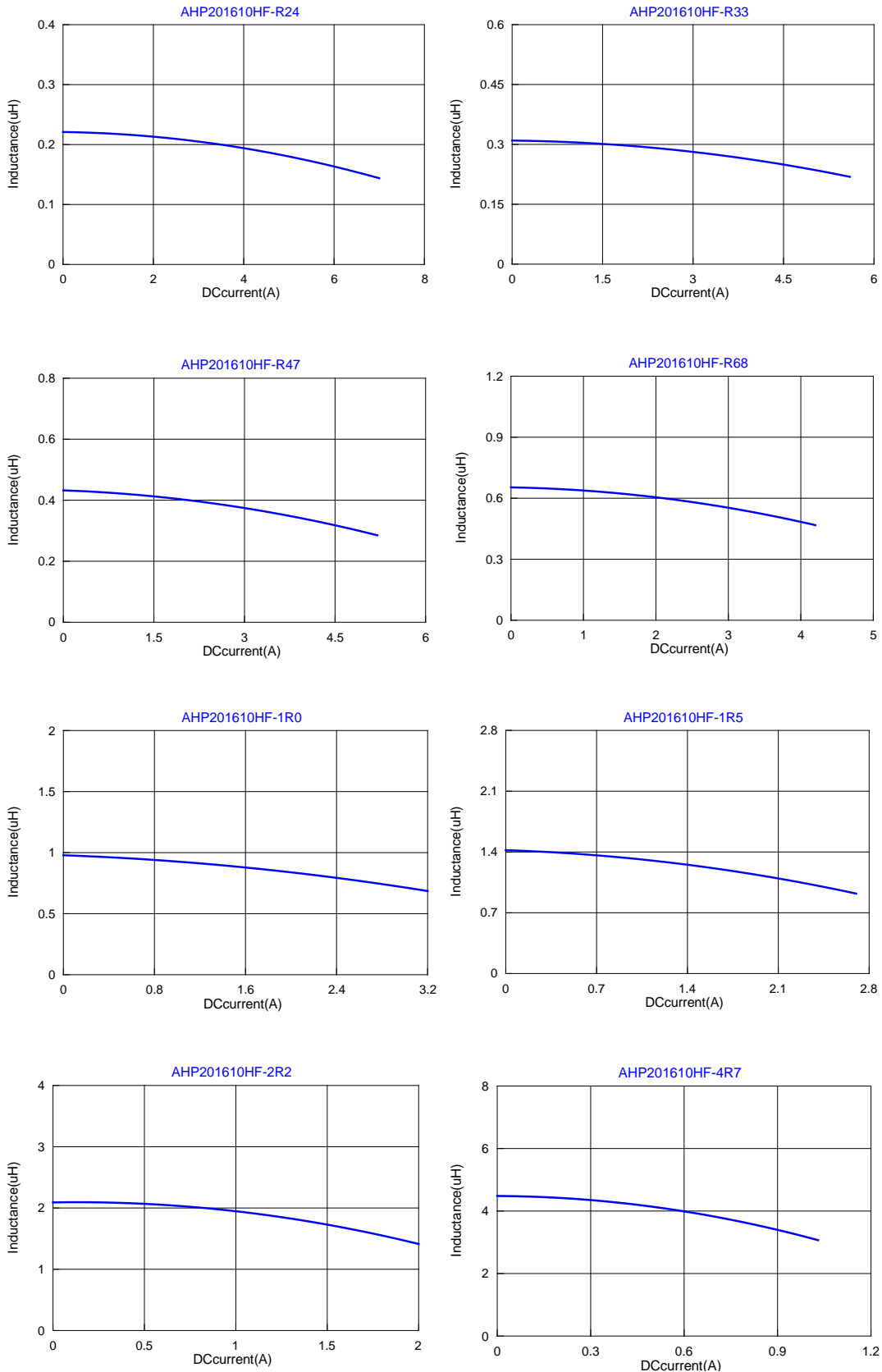

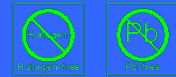

■ Dimensions

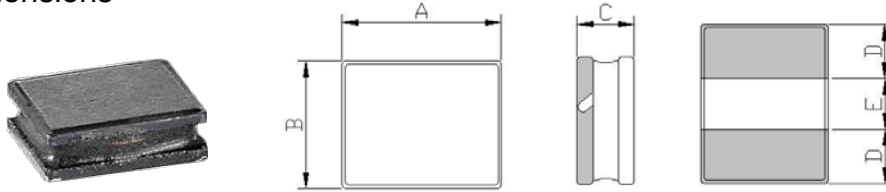

Series	A(mm)	B(mm)	C(mm)	D(mm)	E(mm)
AHP252010RA	2.5 -0.1/+0.2	2.0 -0.1/+0.2	0.8Max	0.75 ref.	1.00 ref.

Units: mm

■ Specifications

TAI-TECH Part Number	Inductance (uH)	Tolerance (%)	Test Frequency (Hz)	DCR (Ω) typ.	DCR (Ω) Max.	I sat (A) typ.	I sat (A) Max.	I rms (A) typ	I rms (A) Max
AHP252008RA-R24M	0.24	±20	1V/1M	0.035	0.042	5.30	4.80	4.50 (1) 4.70 (2)	4.00 (1) 4.20 (2)
AHP252008RA-R33M	0.33	±20	1V/1M	0.040	0.055	4.80	4.30	3.90 (1) 4.30 (2)	3.50 (1) 3.90 (2)
AHP252008RA-R47M	0.47	±20	1V/1M	0.045	0.060	4.50	4.00	3.70 (1) 4.10 (2)	3.30 (1) 3.70 (2)
AHP252008RA-R68M	0.68	±20	1V/1M	0.060	0.075	4.00	3.50	3.50 (1) 2.50 (2)	3.00 (1) 3.20 (2)
AHP252008RA-1R0M	1.0	±20	1V/1M	0.070	0.90	3.20	2.80	2.80 (1) 3.20 (2)	2.50 (1) 2.80 (2)
AHP252008RA-1R5M	1.5	±20	1V/1M	0.105	0.127	2.80	2.60	2.30 (1) 2.50 (2)	2.10 (1) 2.30 (2)
AHP252008RA-2R2M	2.2	±20	1V/1M	0.150	0.180	2.00	1.80	1.80 (1) 2.20 (2)	1.60 (1) 1.80 (2)
AHP252008RA-3R3M	3.3	±20	1V/1M	0.220	0.260	1.60	1.30	1.60 (1) 1.80 (2)	1.30 (1) 1.50 (2)
AHP252008RA-4R7M	4.7	±20	1V/1M	0.360	0.430	1.50	1.20	1.20 (1) 1.30 (2)	1.00 (1) 1.10 (2)

Note:

I_{sat} : Based on inductance change (ΔL/L₀ : ≤30%) @ ambient temp. 25°C

I_{rms} : Based on temperature rise (ΔT : 40°C.) Max

Measurement board data

I_{rms1}

Material : FR4

Board dimensions : 100 X 50 X 1.6t mm

Pattern dimensions: 45 X 30 mm (Double side board)

Pattern thickness : 50 μm

I_{rms2}

Material: FR4

Board dimensions : 100 X 50 X 1.6t mm

Pattern dimensions: 45 X 45 mm (Double side board)

Pattern thickness : 70 μm

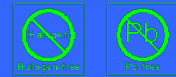

DC Bias Characteristics (Typical)

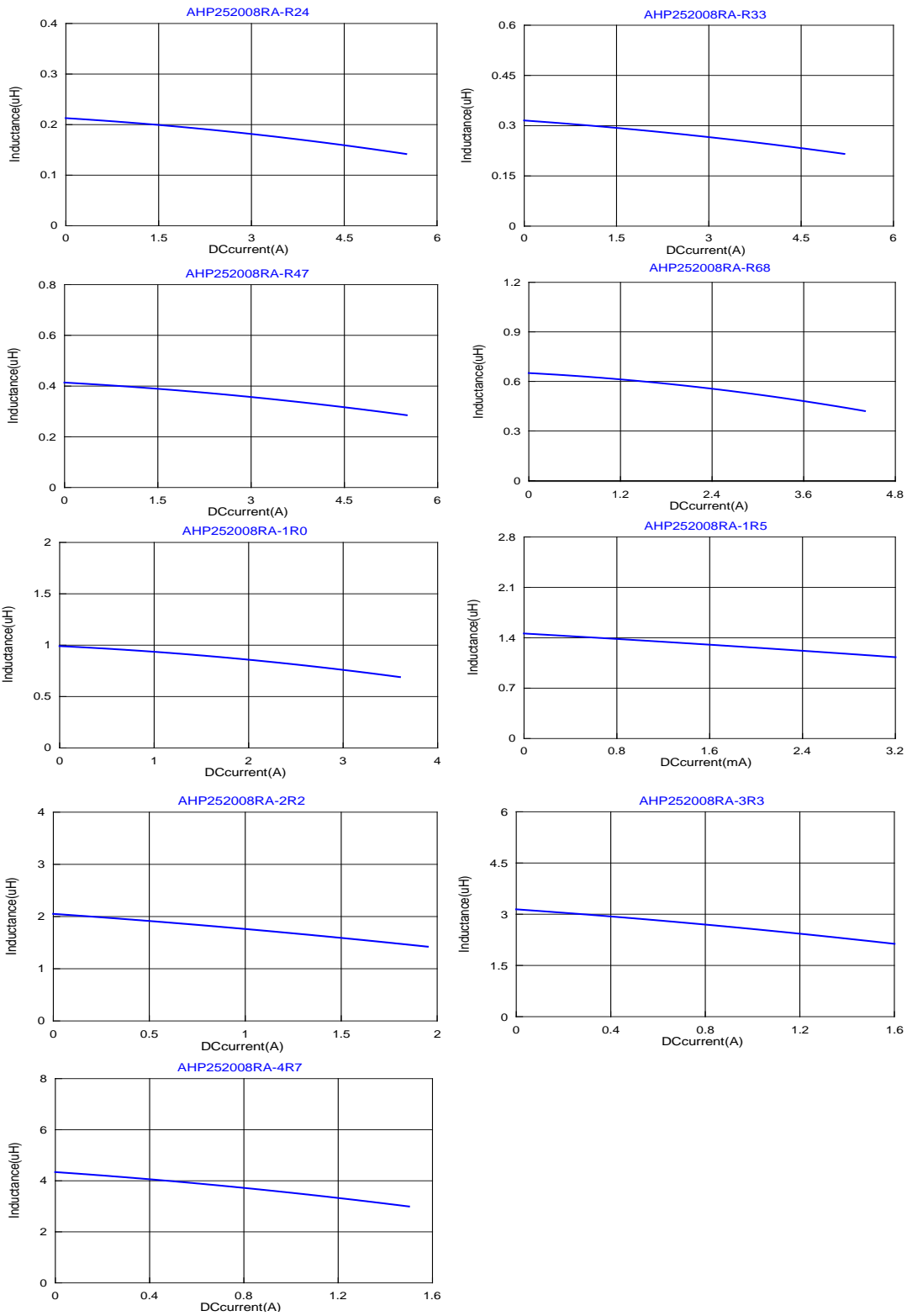



■ Dimensions

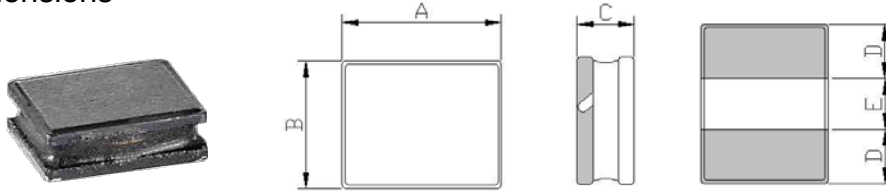

Series	A(mm)	B(mm)	C(mm)	D(mm)	E(mm)
AHP252010FA	2.5 -0.1/+0.2	2.0 -0.1/+0.2	1.0Max	0.75 ref.	1.00 ref.

Units: mm

■ Specifications

TAI-TECH Part Number	Inductance (uH)	Tolerance (%)	Test Frequency (Hz)	DCR (Ω) typ.	DCR (Ω) Max.	I sat (A) typ.	I sat (A) Max.	I rms (A) typ	I rms (A) Max
AHP252010FA-R24M	0.24	±20	1V/1M	0.018	0.022	9.50	8.00	5.50 (1) 6.00 (2)	5.00 (1) 5.50 (2)
AHP252010FA-R33M	0.33	±20	1V/1M	0.023	0.028	8.00	6.50	5.30 (1) 5.60 (2)	4.80 (1) 5.10 (2)
AHP252010FA-R47M	0.47	±20	1V/1M	0.027	0.035	7.00	5.90	4.60 (1) 5.30 (2)	4.20 (1) 4.80 (2)
AHP252010FA-R68M	0.68	±20	1V/1M	0.032	0.040	5.50	4.60	4.20 (1) 4.40 (2)	3.80 (1) 4.00 (2)
AHP252010FA-1R0M	1.0	±20	1V/1M	0.044	0.053	4.90	4.30	3.50 (1) 3.70 (2)	3.10 (1) 3.40 (2)
AHP252010FA-1R5M	1.5	±20	1V/1M	0.062	0.074	3.80	3.10	3.20 (1) 3.40 (2)	2.80 (1) 3.00 (2)
AHP252010FA-2R2M	2.2	±20	1V/1M	0.078	0.093	2.80	2.30	2.60 (1) 2.80 (2)	2.30 (1) 2.50 (2)
AHP252010FA-4R7M	4.7	±20	1V/1M	0.180	0.216	1.70	1.40	1.70 (1) 1.80 (2)	1.50 (1) 1.60 (2)

Note:

I_{sat} : Based on inductance change (ΔL/L0 : ≤30%) @ ambient temp. 25°C

I_{rms} : Based on temperature rise (ΔT : 40°C.) Max

Measurement board data

I_{rms1}

Material : FR4

Board dimensions : 100 X 50 X 1.6t mm

Pattern dimensions: 45 X 30 mm (Double side board)

Pattern thickness : 50 μm

I_{rms2}

Material: FR4

Board dimensions : 100 X 50 X 1.6t mm

Pattern dimensions: 45 X 45 mm (Double side board)

Pattern thickness : 70 μm



■ DC Bias Characteristics (Typical)

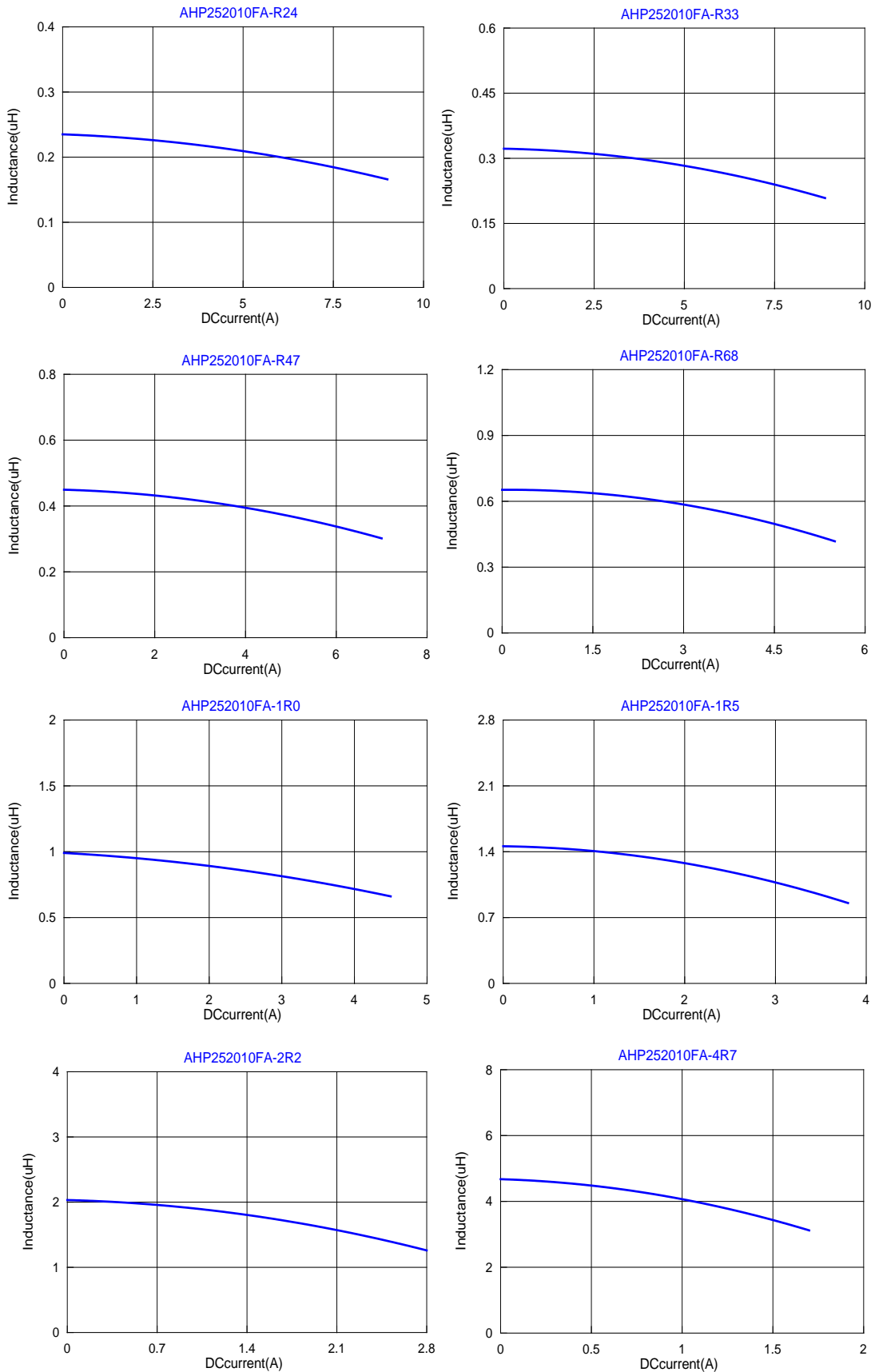

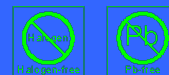

■ Dimensions

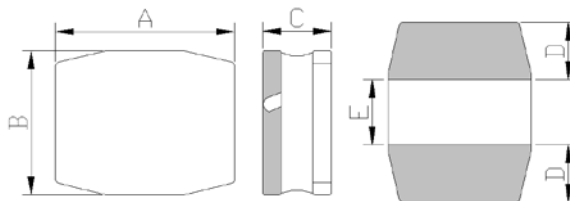

Series	A(mm)	B(mm)	C(mm)	D(mm)	E(mm)
AHP252010HF	2.5 -0.1/+0.2	2.0 -0.1/+0.2	1.0Max	0.75 ref.	1.00 ref.

Units: mm

■ Specifications

TAI-TECH Part Number	Inductance (uH)	Tolerance (%)	Test Frequency (Hz)	DCR (Ω) typ.	DCR (Ω) Max.	I sat (A) typ.	I sat (A) Max.	I rms (A) typ	I rms (A) Max
AHP252010HF-R24M	0.24	±20	1V/1M	0.022	0.028	7.20	6.70	5.50 (1) 6.00 (2)	5.00 (1) 5.50 (2)
AHP252010HF-R33M	0.33	±20	1V/1M	0.023	0.029	6.00	5.50	4.80 (1) 5.00 (2)	4.30 (1) 4.50 (2)
AHP252010HF-R47M	0.47	±20	1V/1M	0.029	0.035	5.50	4.90	4.50 (1) 4.70 (2)	3.90 (1) 4.20 (2)
AHP252010HF-R68M	0.68	±20	1V/1M	0.036	0.043	4.40	3.80	3.80 (1) 4.00 (2)	3.40 (1) 3.60 (2)
AHP252010HF-1R0M	1.0	±20	1V/1M	0.044	0.053	3.60	3.10	3.50 (1) 3.70 (2)	3.00 (1) 3.20 (2)
AHP252010HF-1R5M	1.5	±20	1V/1M	0.072	0.086	3.20	2.70	2.50 (1) 2.80 (2)	2.20 (1) 2.40 (2)
AHP252010HF-2R2M	2.2	±20	1V/1M	0.090	0.108	2.50	2.10	2.40 (1) 2.60 (2)	2.10 (1) 2.30 (2)
AHP252010HF-4R7M	4.7	±20	1V/1M	0.220	0.264	1.70	1.40	1.40 (1) 1.60 (2)	1.20 (1) 1.40 (2)

Note:

I_{sat} : Based on inductance change (ΔL/L0 : ≤30%) @ ambient temp. 25°C

I_{rms} : Based on temperature rise (ΔT : 40°C.) Max

Measurement board data

I_{rms1}

Material : FR4

Board dimensions : 100 X 50 X 1.6t mm

Pattern dimensions: 45 X 30 mm (Double side board)

Pattern thickness : 50 μm

I_{rms2}

Material: FR4

Board dimensions : 100 X 50 X 1.6t mm

Pattern dimensions: 45 X 45 mm (Double side board)

Pattern thickness : 70 μm

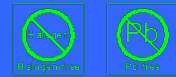

■ DC Bias Characteristics (Typical)

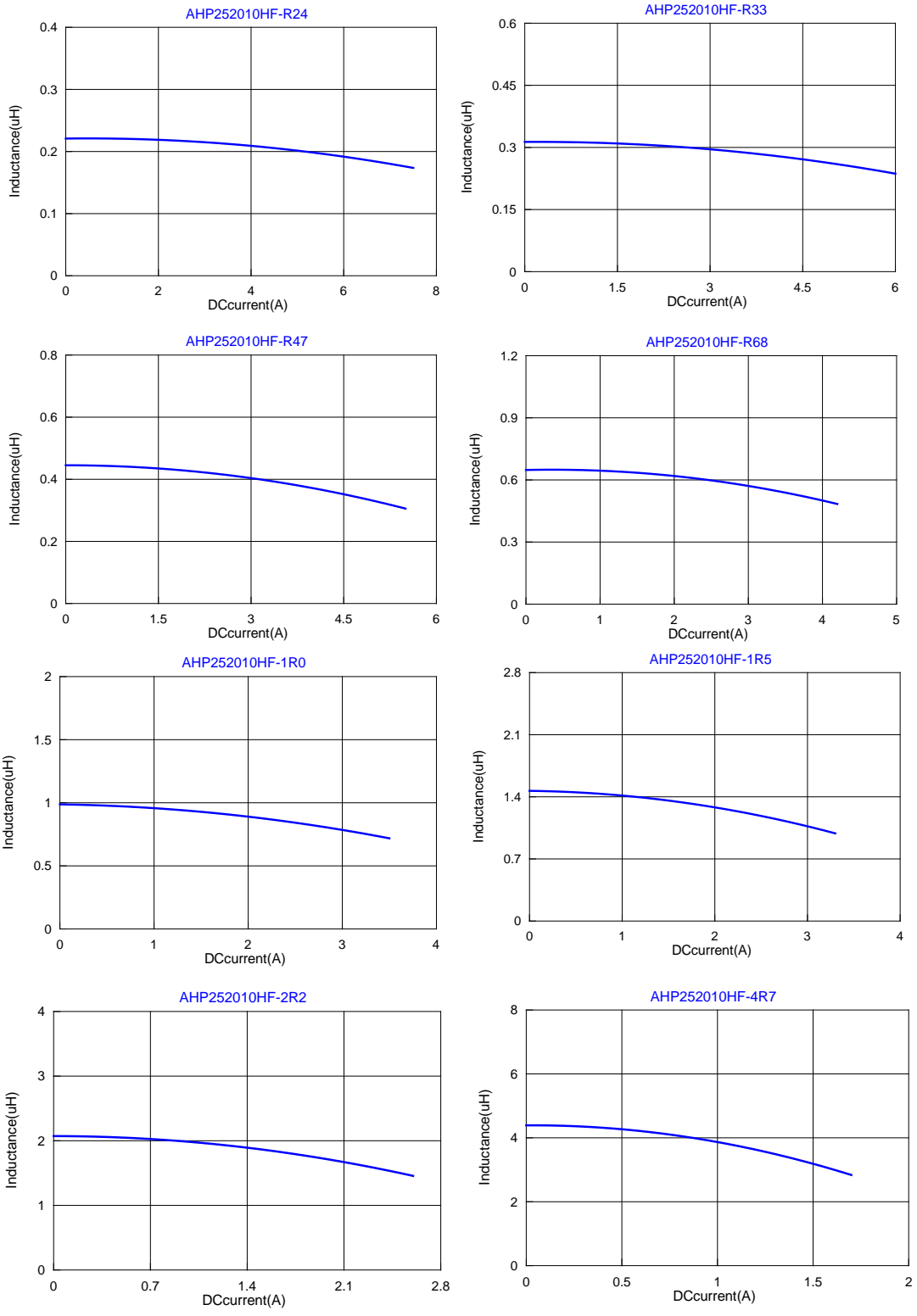

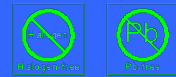

■ Dimensions

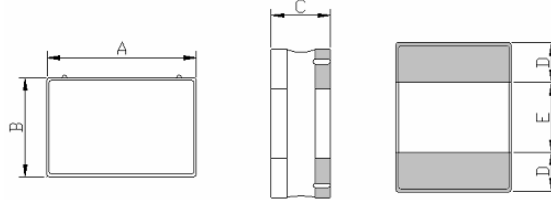

Series	A(mm)	B(mm)	C(mm)	D(mm)	E(mm)
AHP252012RA	2.5 -0.1/+0.2	2.0 -0.1/+0.2	1.2Max	0.75 ref.	1.00 ref.

Units: mm

■ Specifications

TAI-TECH Part Number	Inductance (uH)	Tolerance (%)	Test Frequency (Hz)	DCR (Ω) typ.	DCR (Ω) Max.	I sat (A) typ.	I sat (A) Max.	I rms (A) typ	I rms (A) MAX
AHP252012RA-R24M	0.24	±20	1V/1M	0.018	0.022	8.00	7.00	5.50(1) 6.00(2)	5.00(1) 5.50(2)
AHP252012RA-R33M	0.33	±20	1V/1M	0.023	0.028	7.00	6.00	5.10(1) 5.60(2)	4.60(1) 5.10(2)
AHP252012RA-R47M	0.47	±20	1V/1M	0.027	0.035	6.00	5.00	4.80(1) 5.30(2)	4.30(1) 4.80(2)
AHP252012RA-R68M	0.68	±20	1V/1M	0.036	0.045	5.00	4.50	4.00(1) 4.50(2)	3.60(1) 4.00(2)
AHP252012RA-1R0M	1.0	±20	1V/1M	0.045	0.058	4.30	3.80	3.50(1) 3.80(2)	3.20(1) 3.50(2)
AHP252012RA-1R5M	1.5	±20	1V/1M	0.060	0.072	3.50	3.00	3.10(1) 3.50(2)	2.70(1) 3.10(2)
AHP252012RA-2R2M	2.2	±20	1V/1M	0.090	0.108	3.10	2.60	2.50(1) 2.80(2)	2.20(1) 2.50(2)
AHP252012RA-3R3M	3.3	±20	1V/1M	0.125	0.150	2.20	1.90	2.10(1) 2.50(2)	1.80(1) 2.20(2)
AHP252012RA-4R7M	4.7	±20	1V/1M	0.190	0.220	2.00	1.70	1.70(1) 1.90(2)	1.40(1) 1.60(2)
AHP252012RA-6R8M	6.8	±20	1V/1M	0.300	0.360	1.80	1.50	1.20(1) 1.30(2)	1.00(1) 1.10(2)
AHP252012RA-100M	10	±20	1V/1M	0.420	0.475	1.40	1.10	1.00(1) 1.10(2)	0.90(1) 1.00(2)

Note:

I_{sat} : Based on inductance change (ΔL/L0 : ≤30%) @ ambient temp. 25°C

I_{rms} : Based on temperature rise (ΔT : 40°C.) Max

Measurement board data

I_{rms1}

Material : FR4

Board dimensions : 100 X 50 X 1.6t mm

Pattern dimensions: 45 X 30 mm (Double side board)

Pattern thickness : 50 μm

I_{rms2}

Material: FR4

Board dimensions : 100 X 50 X 1.6t mm

Pattern dimensions: 45 X 45 mm (Double side board)

Pattern thickness : 70 μm



■ DC Bias Characteristics (Typical)

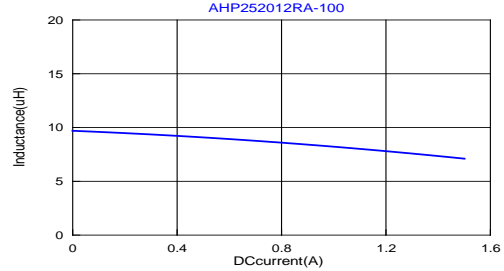
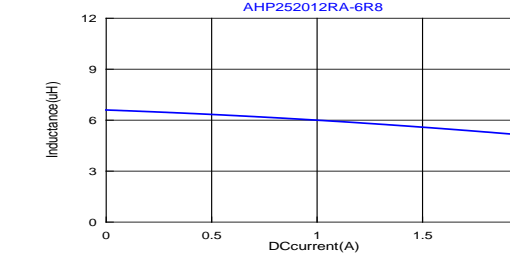
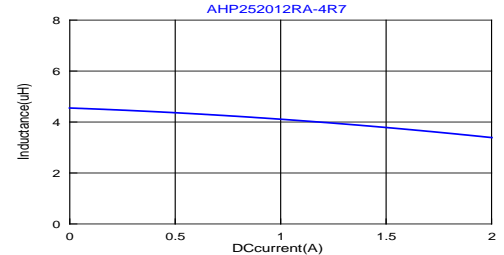
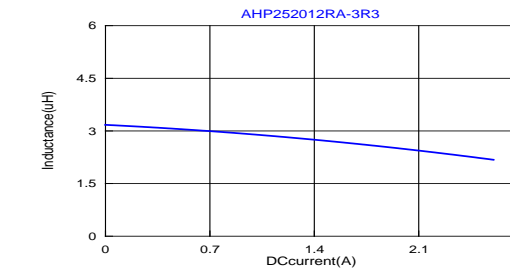
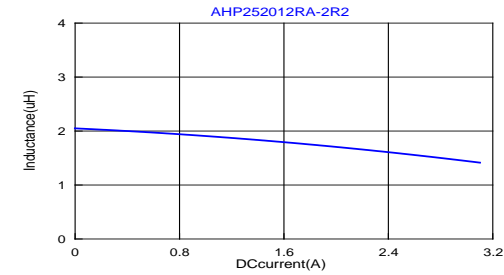
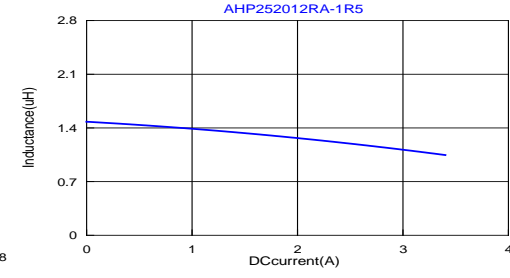
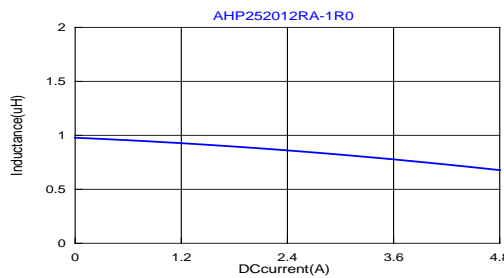
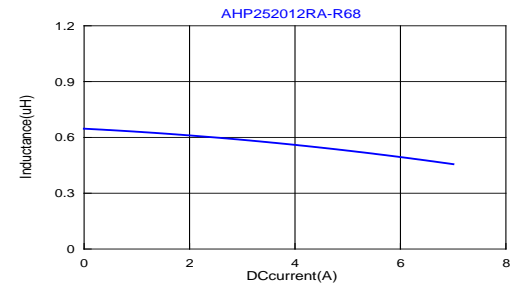
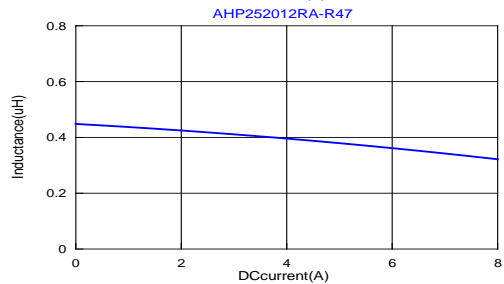
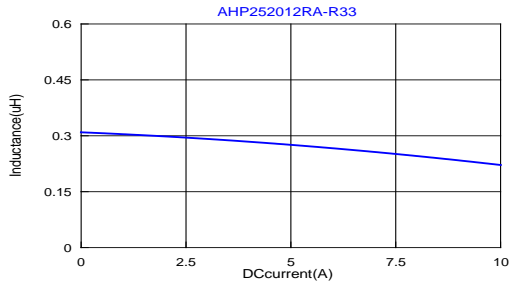
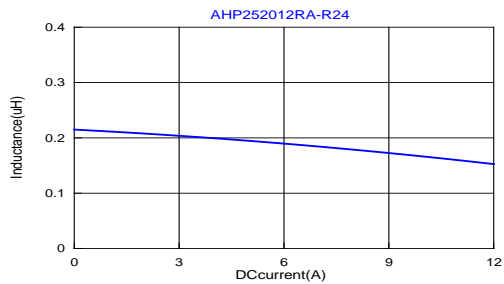

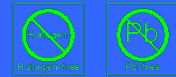

■ Dimensions

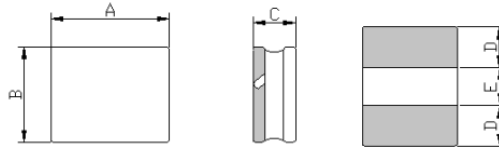

Series	A(mm)	B(mm)	C(mm)	D(mm)	E(mm)
AHP252012HF	2.5 -0.1/+0.2	2.0 -0.1/+0.2	1.2Max	0.75 ref.	1.00 ref.

Units: mm

■ Specifications

TAI-TECH Part Number	Inductance (uH)	Tolerance (%)	Test Frequency (Hz)	DCR (Ω) typ.	DCR (Ω) Max.	I sat (A) typ.	I sat (A) Max.	I rms (A) typ	I rms (A) Max
AHP252012HF-R24M	0.24	±20	1V/1M	0.011	0.015	7.80	6.50	7.00 (1) 7.50 (2)	6.00 (1) 6.50 (2)
AHP252012HF-R33M	0.33	±20	1V/1M	0.017	0.023	7.00	6.00	5.80 (1) 6.30 (2)	4.80 (1) 5.20 (2)
AHP252012HF-R47M	0.47	±20	1V/1M	0.021	0.027	6.50	5.50	5.00 (1) 5.50 (2)	4.20 (1) 4.70 (2)
AHP252012HF-R68M	0.68	±20	1V/1M	0.030	0.037	6.00	5.00	4.50 (1) 5.00 (2)	3.90 (1) 4.20 (2)

Note:

I_{sat} : Based on inductance change ($\Delta L/L_0 : \leq 30\%$) @ ambient temp. 25°C

I_{rms} : Based on temperature rise ($\Delta T : 40^\circ\text{C}.$) Max

Measurement board data

I_{rms1}

Material : FR4

Board dimensions : 100 X 50 X 1.6t mm

Pattern dimensions: 45 X 30 mm (Double side board)

Pattern thickness : 50 μm

I_{rms2}

Material: FR4

Board dimensions : 100 X 50 X 1.6t mm

Pattern dimensions: 45 X 45 mm (Double side board)

Pattern thickness : 70 μm



■ DC Bias Characteristics (Typical)

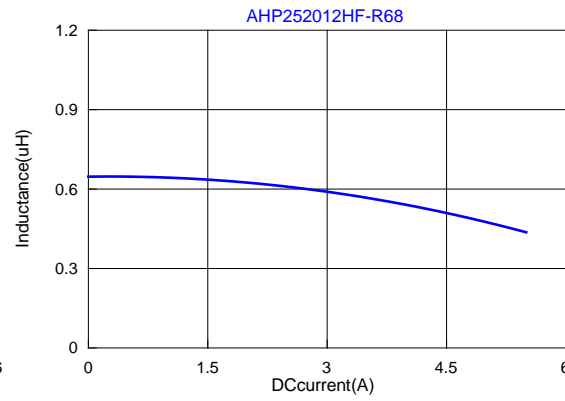
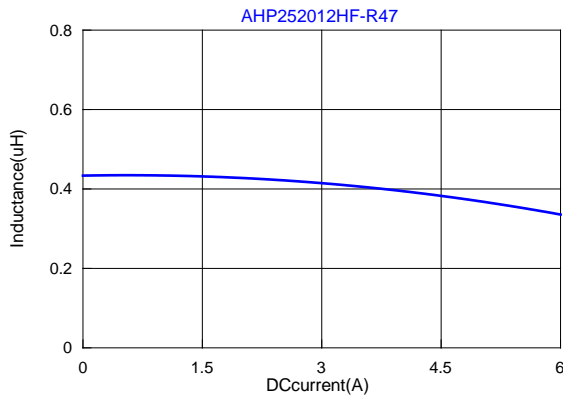
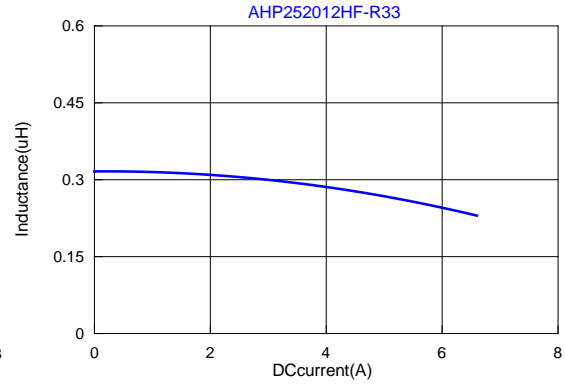
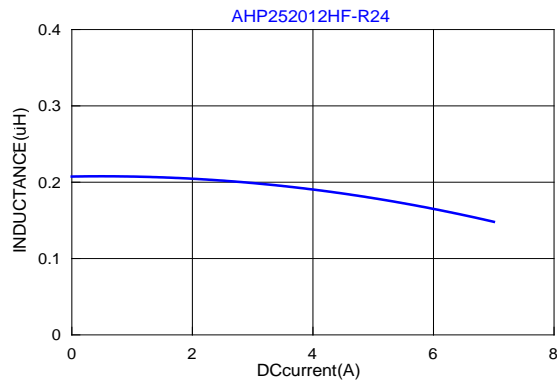

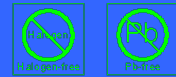

■ Dimensions

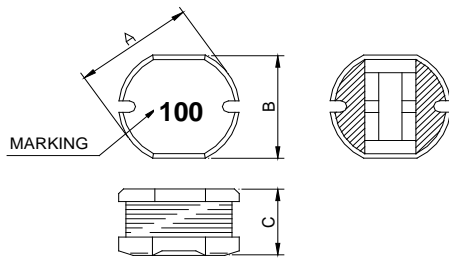

Size	A(mm)	B(mm)	C(mm)
FPI 0302BM	3.50±0.3	3.00±0.3	2.10±0.3

■ Specifications

TAI-TECH Part Number	Inductance (uH)	Tolerance (%)	Test Frequency (Hz)	DCR (Ω) max.	IDC (A) max.
FPI 0302BM-1R0M	1.0	± 20%	1V/7.96M	0.04	1.50
FPI 0302BM-1R4M	1.4	± 20%	1V/7.96M	0.05	1.50
FPI 0302BM-1R8M	1.8	± 20%	1V/7.96M	0.06	0.80
FPI 0302BM-2R2M	2.2	± 20%	1V/7.96M	0.08	0.75
FPI 0302BM-2R7M	2.7	± 20%	1V/7.96M	0.10	0.75
FPI 0302BM-3R3M	3.3	± 20%	1V/7.96M	0.15	0.60
FPI 0302BM-3R9M	3.9	± 20%	1V/7.96M	0.20	0.50
FPI 0302BM-4R7M	4.7	± 20%	1V/7.96M	0.20	0.50
FPI 0302BM-5R6M	5.6	± 20%	1V/7.96M	0.23	0.45
FPI 0302BM-6R8M	6.8	± 20%	1V/7.96M	0.25	0.40
FPI 0302BM-8R2M	8.2	± 20%	1V/7.96M	0.30	0.40
FPI 0302BM-100M	10	± 20%	1V/2.52M	0.35	0.35
FPI 0302BM-120M	12	± 20%	1V/2.52M	0.40	0.35
FPI 0302BM-150M	15	± 20%	1V/2.52M	0.50	0.30
FPI 0302BM-180M	18	± 20%	1V/2.52M	0.55	0.30
FPI 0302BM-220M	22	± 20%	1V/2.52M	0.60	0.30
FPI 0302BM-270M	27	± 20%	1V/2.52M	0.70	0.30
FPI 0302BM-330M	33	± 20%	1V/2.52M	1.00	0.25
FPI 0302BM-390M	39	± 20%	1V/2.52M	1.20	0.25
FPI 0302BM-470M	47	± 20%	1V/2.52M	1.50	0.20
FPI 0302BM-560M	56	± 20%	1V/2.52M	1.80	0.20
FPI 0302BM-680M	68	± 20%	1V/2.52M	2.00	0.18
FPI 0302BM-820M	82	± 20%	1V/2.52M	2.50	0.16
FPI 0302BM-101M	100	± 20%	1V/1K	3.00	0.15
FPI 0302BM-121M	120	± 20%	1V/1K	3.50	0.14

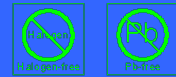

TAI-TECH Part Number	Inductance (μ H)	Tolerance (%)	Test Frequency (Hz)	DCR (Ω) max.	IDC (A) max.
FPI 0302BM-151M	150	$\pm 20\%$	1V/1K	4.00	0.13
FPI 0302BM-181M	180	$\pm 20\%$	1V/1K	5.00	0.12
FPI 0302BM-221M	220	$\pm 20\%$	1V/1K	5.50	0.10
FPI 0302BM-271M	270	$\pm 20\%$	1V/1K	6.00	0.10
FPI 0302BM-331M	330	$\pm 20\%$	1V/1K	7.00	0.10
FPI 0302BM-391M	390	$\pm 20\%$	1V/1K	8.00	0.10
FPI 0302BM-471M	470	$\pm 20\%$	1V/1K	12.0	0.09

Note:

Based on inductance change ($\Delta L/L0 : \leq -35\%$) @ ambient temp. 25°C

Based on temperature rise ($\Delta T : 40^\circ\text{C}$ typ.)

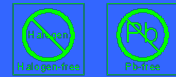

■ Dimensions

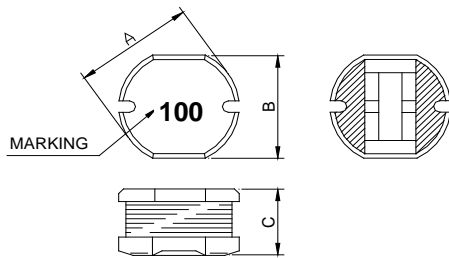

Size	A(mm)	B(mm)	C(mm)
FPI 0403BM	4.50±0.3	4.00±0.3	3.20±0.3

■ Specifications

TAI-TECH Part Number	Inductance (uH)	Tolerance (%)	Test Frequency (Hz)	DCR (Ω) max.	IDC (A) max.
FPI 0403BM-1R0M	1.0	± 20%	1V/7.96M	0.03	4.00
FPI 0403BM-1R4M	1.4	± 20%	1V/7.96M	0.04	3.50
FPI 0403BM-1R8M	1.8	± 20%	1V/7.96M	0.05	3.00
FPI 0403BM-2R2M	2.2	± 20%	1V/7.96M	0.06	2.60
FPI 0403BM-2R7M	2.7	± 20%	1V/7.96M	0.06	2.20
FPI 0403BM-3R3M	3.3	± 20%	1V/7.96M	0.07	2.00
FPI 0403BM-3R9M	3.9	± 20%	1V/7.96M	0.07	2.00
FPI 0403BM-4R7M	4.7	± 20%	1V/7.96M	0.08	1.90
FPI 0403BM-5R6M	5.6	± 20%	1V/7.96M	0.12	1.80
FPI 0403BM-6R8M	6.8	± 20%	1V/7.96M	0.14	1.60
FPI 0403BM-8R2M	8.2	± 20%	1V/7.96M	0.15	1.40
FPI 0403BM-100M	10	± 20%	1V/2.52M	0.19	1.10
FPI 0403BM-120M	12	± 20%	1V/2.52M	0.21	1.10
FPI 0403BM-150M	15	± 20%	1V/2.52M	0.25	1.00
FPI 0403BM-180M	18	± 20%	1V/2.52M	0.30	1.00
FPI 0403BM-220M	22	± 20%	1V/2.52M	0.35	1.00
FPI 0403BM-270M	27	± 20%	1V/2.52M	0.45	0.75
FPI 0403BM-330M	33	± 20%	1V/2.52M	0.60	0.70
FPI 0403BM-390M	39	± 20%	1V/2.52M	0.70	0.65
FPI 0403BM-470M	47	± 20%	1V/2.52M	0.80	0.60
FPI 0403BM-560M	56	± 20%	1V/2.52M	0.85	0.55
FPI 0403BM-680M	68	± 20%	1V/2.52M	1.00	0.50
FPI 0403BM-820M	82	± 20%	1V/2.52M	1.10	0.46
FPI 0403BM-101M	100	± 20%	1V/1K	1.20	0.22
FPI 0403BM-121M	120	± 20%	1V/1K	1.60	0.20

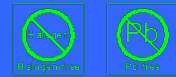

TAI-TECH Part Number	Inductance (μ H)	Tolerance (%)	Test Frequency (Hz)	DCR (Ω) max.	IDC (A) max.
FPI 0403BM-151M	150	$\pm 20\%$	1V/1K	2.00	0.20
FPI 0403BM-181M	180	$\pm 20\%$	1V/1K	3.00	0.20
FPI 0403BM-221M	220	$\pm 20\%$	1V/1K	3.00	0.20
FPI 0403BM-271M	270	$\pm 20\%$	1V/1K	4.00	0.16
FPI 0403BM-331M	330	$\pm 20\%$	1V/1K	4.00	0.14
FPI 0403BM-391M	390	$\pm 20\%$	1V/1K	5.00	0.12
FPI 0403BM-471M	470	$\pm 20\%$	1V/1K	6.00	0.12
FPI 0403BM-561M	560	$\pm 20\%$	1V/1K	7.00	0.10

Note:

Based on inductance change ($\Delta L/L_0 : \leq -35\%$) @ ambient temp. 25°C

Based on temperature rise ($\Delta T : 40^\circ\text{C}$ typ.)



■ Dimensions

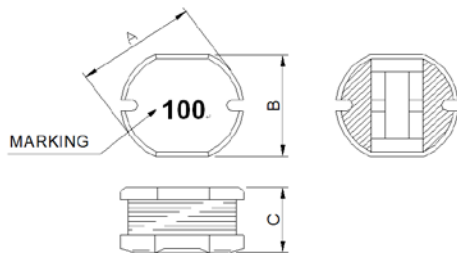

Size	A(mm)	B(mm)	C(mm)
FPI 0503BM	5.80±0.3	5.20±0.3	3.00±0.3

■ Specifications

TAI-TECH Part Number	Inductance (uH)	Tolerance (%)	Test Frequency (Hz)	DCR (Ω) max.	Isat (A) max.	Irms (A) max.
FPI0503BM-1R5M	1.50	± 20%	1V/100K	37	4.10	4.10
FPI0503BM-1R8M	1.80	± 20%	1V/7.96M	50	4.00	2.80
FPI0503BM-4R7M	4.70	± 20%	1V/7.96M	130	1.30	1.30
FPI0503BM-6R8M	6.80	± 20%	1V/7.96M	71	1.87	1.87
FPI0503BM-8R2M	8.20	± 20%	1V/7.96M	100	2.00	2.00
FPI0503BM-100M	10.0	± 20%	1V/2.52M	200	1.90	1.90
FPI0503BM-330M	33.0	± 20%	1V/2.52M	450	1.40	1.40

Note:

Based on inductance change ($\Delta L/L_0 : \leq -35\%$) @ ambient temp. 25°C

Based on temperature rise ($\Delta T : 40^\circ\text{C}$ typ.)



■ Dimensions

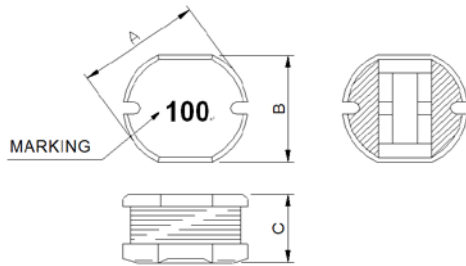

Size	A(mm)	B(mm)	C(mm)
FPI 0504	5.80±0.3	5.20±0.3	4.50±0.3

■ Specifications

TAI-TECH Part Number	Inductance (uH)	Tolerance (%)	Test Frequency (Hz)	DCR (Ω) max.	IDC (A) max.
FPI 0504BM-1R0M	1.0	± 20%	1V/7.96M	0.018	3.50
FPI 0504BM-1R4M	1.4	± 20%	1V/7.96M	0.020	3.50
FPI 0504BM-1R8M	1.8	± 20%	1V/7.96M	0.025	3.00
FPI 0504BM-2R2M	2.2	± 20%	1V/7.96M	0.030	2.80
FPI 0504BM-2R7M	2.7	± 20%	1V/7.96M	0.035	2.60
FPI 0504BM-3R3M	3.3	± 20%	1V/7.96M	0.040	2.50
FPI 0504BM-3R9M	3.9	± 20%	1V/7.96M	0.050	2.30
FPI 0504BM-4R7M	4.7	± 20%	1V/7.96M	0.060	2.60
FPI 0504BM-5R6M	5.6	± 20%	1V/7.96M	0.070	2.40
FPI 0504BM-6R8M	6.8	± 20%	1V/7.96M	0.080	2.20
FPI 0504BM-8R2M	8.2	± 20%	1V/7.96M	0.080	2.00
FPI 0504BM-100M	10	± 20%	1V/2.52M	0.090	1.80
FPI 0504BM-120M	12	± 20%	1V/2.52M	0.100	1.60
FPI 0504BM-150M	15	± 20%	1V/2.52M	0.120	1.50
FPI 0504BM-180M	18	± 20%	1V/2.52M	0.150	1.40
FPI 0504BM-220M	22	± 20%	1V/2.52M	0.180	1.30
FPI 0504BM-270M	27	± 20%	1V/2.52M	0.220	1.20
FPI 0504BM-330M	33	± 20%	1V/2.52M	0.260	1.00
FPI 0504BM-390M	39	± 20%	1V/2.52M	0.300	0.90
FPI 0504BM-470M	47	± 20%	1V/2.52M	0.350	0.85
FPI 0504BM-560M	56	± 20%	1V/2.52M	0.400	0.80
FPI 0504BM-680M	68	± 20%	1V/2.52M	0.450	0.70
FPI 0504BM-820M	82	± 20%	1V/2.52M	0.500	0.70
FPI 0504BM-101M	100	± 20%	1V/1K	0.700	0.60
FPI 0504BM-121M	120	± 20%	1V/1K	0.750	0.60



TAI-TECH Part Number	Inductance (μ H)	Tolerance (%)	Test Frequency (Hz)	DCR (Ω) max.	IDC (A) max.
FPI 0504BM-151M	150	$\pm 20\%$	1V/1K	0.900	0.55
FPI 0504BM-181M	180	$\pm 20\%$	1V/1K	1.100	0.50
FPI 0504BM-221M	220	$\pm 20\%$	1V/1K	1.200	0.40
FPI 0504BM-271M	270	$\pm 20\%$	1V/1K	1.500	0.25
FPI 0504BM-331M	330	$\pm 20\%$	1V/1K	3.000	0.22
FPI 0504BM-391M	390	$\pm 20\%$	1V/1K	3.500	0.20
FPI 0504BM-471M	470	$\pm 20\%$	1V/1K	4.000	0.19
FPI 0504BM-561M	560	$\pm 20\%$	1V/1K	4.000	0.18
FPI 0504BM-681M	680	$\pm 20\%$	1V/1K	4.500	0.15

Note:

Based on inductance change ($\Delta L/L0 : \leq -35\%$) @ ambient temp. 25°C

Based on temperature rise ($\Delta T : 40^\circ\text{C}$ typ.)

■ Dimensions

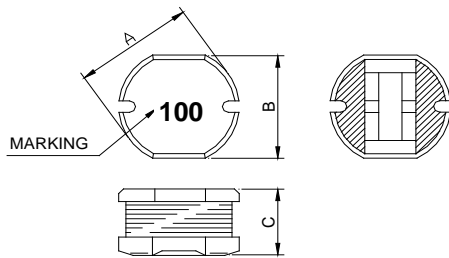

Size	A(mm)	B(mm)	C(mm)
FPI 0703	7.80±0.3	7.00±0.3	3.50±0.3

■ Specifications

TAI-TECH Part Number	Inductance (uH)	Tolerance (%)	Test Frequency (Hz)	DCR (Ω) max.	IDC (A) max.
FPI 0703BM-100M	10	± 20%	1V/2.52M	0.0803	1.44
FPI 0703BM-120M	12	± 20%	1V/2.52M	0.0897	1.39
FPI 0703BM-150M	15	± 20%	1V/2.52M	0.1040	1.24
FPI 0703BM-180M	18	± 20%	1V/2.52M	0.1110	1.12
FPI 0703BM-220M	22	± 20%	1V/2.52M	0.1290	1.07
FPI 0703BM-270M	27	± 20%	1V/2.52M	0.1530	0.97
FPI 0703BM-330M	33	± 20%	1V/2.52M	0.1700	0.85
FPI 0703BM-390M	39	± 20%	1V/2.52M	0.2170	0.74
FPI 0703BM-470M	47	± 20%	1V/2.52M	0.2520	0.68
FPI 0703BM-560K	56	± 10%	1V/2.52M	0.2820	0.64
FPI 0703BM-680K	68	± 10%	1V/2.52M	0.3320	0.59
FPI 0703BM-820K	82	± 10%	1V/2.52M	0.4060	0.54
FPI 0703BM-101K	100	± 10%	1V/1K	0.4810	0.51
FPI 0703BM-121K	120	± 10%	1V/1K	0.5360	0.49
FPI 0703BM-151K	150	± 10%	1V/1K	0.7550	0.40
FPI 0703BM-181K	180	± 10%	1V/1K	1.0220	0.36
FPI 0703BM-221K	220	± 10%	1V/1K	1.2000	0.31
FPI 0703BM-271K	270	± 10%	1V/1K	1.3060	0.29
FPI 0703BM-331K	330	± 10%	1V/1K	1.4950	0.28

Note:

Based on inductance change ($\Delta L/L_0$: $\leq -35\%$) @ ambient temp. 25°C

Based on temperature rise (ΔT : 40°C typ.)

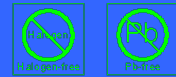

■ Dimensions

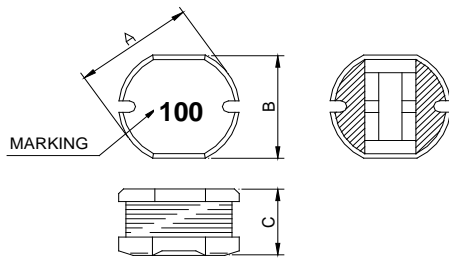

Size	A(mm)	B(mm)	C(mm)
FPI 0705	7.80±0.3	7.00±0.3	5.00±0.3

■ Specifications

TAI-TECH Part Number	Inductance (uH)	Tolerance (%)	Test Frequency (Hz)	DCR (Ω) max.	IDC (A) max.
FPI 0705BM-3R3M	3.30	± 20%	1V/7.96M	0.03	4.60
FPI 0705BM-4R7M	4.70	± 20%	1V/7.96M	0.04	4.20
FPI 0705BM-100M	10.0	± 20%	1V/2.52M	0.07	2.30
FPI 0705BM-120M	12.0	± 20%	1V/2.52M	0.08	2.00
FPI 0705BM-150M	15.0	± 20%	1V/2.52M	0.09	1.80
FPI 0705BM-180M	18.0	± 20%	1V/2.52M	0.10	1.60
FPI 0705BM-220M	22.0	± 20%	1V/2.52M	0.11	1.50
FPI 0705BM-270M	27.0	± 20%	1V/2.52M	0.12	1.30
FPI 0705BM-330M	33.0	± 20%	1V/2.52M	0.13	1.20
FPI 0705BM-390M	39.0	± 20%	1V/2.52M	0.16	1.10
FPI 0705BM-470K	47.0	± 10%	1V/2.52M	0.18	1.10
FPI 0705BM-560K	56.0	± 10%	1V/2.52M	0.24	0.94
FPI 0705BM-680K	68.0	± 10%	1V/2.52M	0.28	0.85
FPI 0705BM-820K	82.0	± 10%	1V/2.52M	0.37	0.78
FPI 0705BM-101K	100	± 10%	1V/1K	0.43	0.72
FPI 0705BM-121K	120	± 10%	1V/1K	0.47	0.66
FPI 0705BM-151K	150	± 10%	1V/1K	0.64	0.58
FPI 0705BM-181K	180	± 10%	1V/1K	0.71	0.51
FPI 0705BM-221K	220	± 10%	1V/1K	0.96	0.49
FPI 0705BM-271K	270	± 10%	1V/1K	1.11	0.42
FPI 0705BM-331K	330	± 10%	1V/1K	1.26	0.40
FPI 0705BM-391K	390	± 10%	1V/1K	1.77	0.36
FPI 0705BM-471K	470	± 10%	1V/1K	1.96	0.34

Note:

Based on inductance change ($\Delta L/L0 : \leq -35\%$) @ ambient temp. 25°C

Based on temperature rise ($\Delta T : 40^\circ\text{C typ.}$)



■ Dimensions

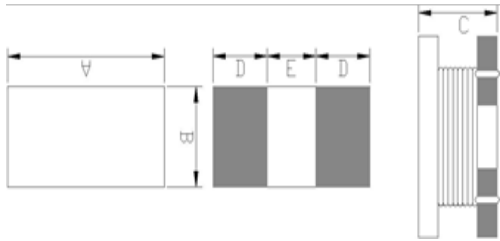

Dimensions	
A	3.20±0.30
B	1.60±0.30
C	1.80 max.
D	1.05 ref.
E	1.05 ref.

Units: mm

■ Specifications

TAI-TECH Part Number	Inductance (uH)	Tolerance (%)	Test Frequency (Hz)	SRF (MHz) min.	DCR (Ω) ±20%	I rms (A)typ
FWP321618F -R47M	0.47	±20%	1V1M	180	0.130	0.70
FWP321618F -2R2M	2.2	±20%	1V1M	50	0.300	0.43
FWP321618F -3R3M	3.3	±20%	1V1M	55	0.350	0.38
FWP321618F -220M	22	±20%	1V1M	14	2.20	0.16

Note:

Isat : Based on inductance change ($\Delta L/L0 : \leq 30\%$) @ ambient temp. 25°C

Irms : Based on temperature rise ($\Delta T : 40^\circ\text{C}$) Max

■ DC Bias Characteristics (Typical)

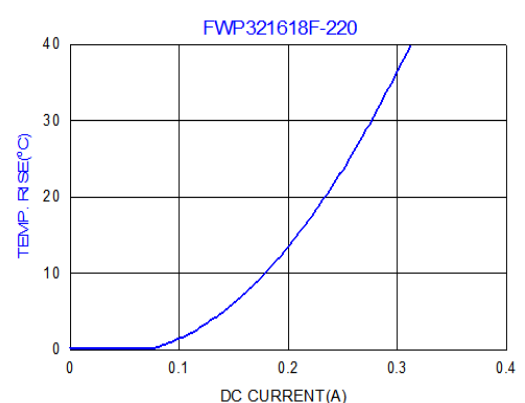
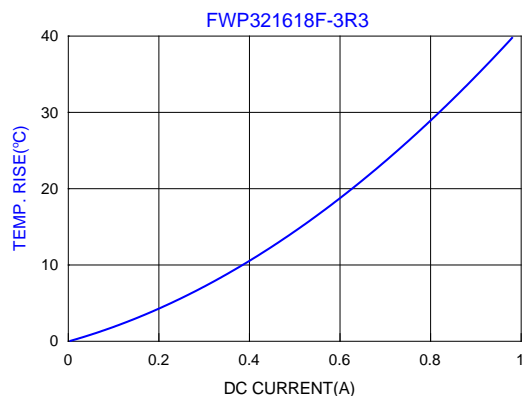
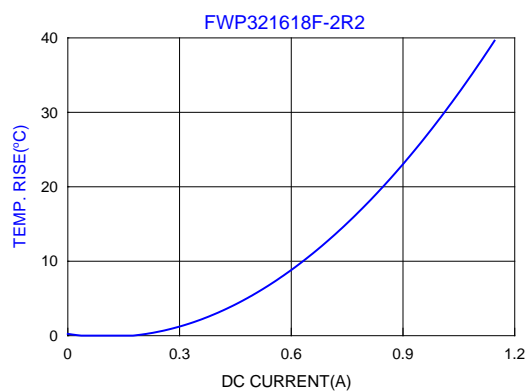
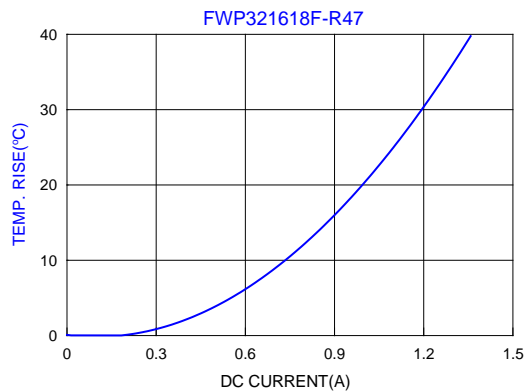

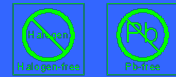

■ Dimensions

Chip Size	
A	10.20±0.30
B	10.00±0.30
C	3.00max
D	3.00±0.10
E	1.20±0.15
F	7.70±0.30

Units: mm

■ Specifications

Part Number	Inductance (uH)	Test Frequency (Hz)	DCR (mΩ) max	I sat (A) max	I rms (A) typ
SDSL10D30F-R80Y	0.80±30%	0.1V/100K	0.0057	11.20	8.30
SDSL10D30F-1R5Y	1.5±30%	0.1V/100K	0.0110	8.00	5.80
SDSL10D30F-2R2Y	2.2±30%	0.1V/100K	0.0169	6.70	5.10
SDSL10D30F-3R3Y	3.3±30%	0.1V/100K	0.0210	5.56	4.70
SDSL10D30F-4R7Y	4.7±30%	0.1V/100K	0.0300	4.65	4.00
SDSL10D30F-6R8Y	6.8±30%	0.1V/100K	0.0350	3.84	3.60
SDSL10D30F-100M	10±20%	0.1V/100K	0.0590	3.18	2.80
SDSL10D30F-150M	15±20%	0.1V/100K	0.0910	2.60	2.05
SDSL10D30F-220M	22±20%	0.1V/100K	0.1430	2.16	1.60
SDSL10D30F-330M	33±20%	0.1V/100K	0.2020	1.74	1.35
SDSL10D30F-470M	47±20%	0.1V/100K	0.2990	1.43	1.20
SDSL10D30F-680M	68±20%	0.1V/100K	0.4290	1.22	0.95
SDSL10D30F-101M	100±20%	0.1V/100K	0.6830	1.02	0.70
SDSL10D30F-151M	150±20%	0.1V/100K	0.8710	0.84	0.51

Note:

1. All test data referenced to 25°C ambient.
2. Heat Rated Current (I_{rms}) will cause the coil temperature rise approximately Δt of 40°C
3. Saturation Current (I_{sat}) will cause L₀ to drop 30% typical.

■ DC Bias Characteristics (Typical)

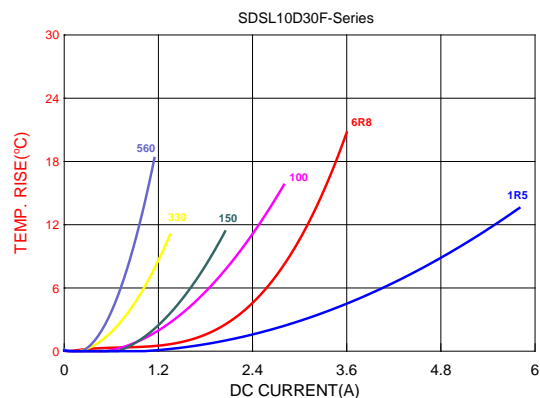
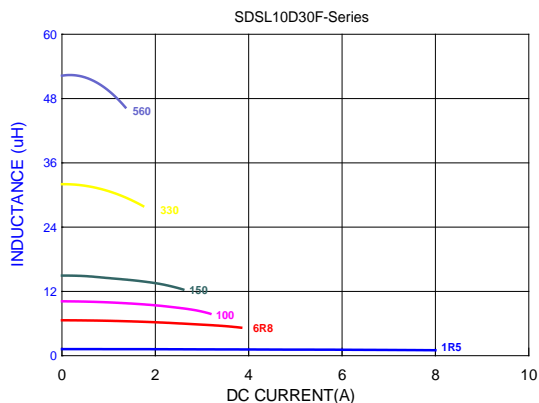

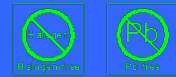

■ Dimensions

Chip Size	
A	10.20±0.30
B	10.00±0.30
C	4.00max
D	3.00±0.10
E	1.20±0.15
F	7.70±0.30

Units: mm

■ Specifications

Part Number	Inductance (uH)	Test Frequency (Hz)	DCR (mΩ) max	I sat (A) max	I rms (A) Typ
SDSL10D40F-1R5Y	1.5±30%	0.1V/100K	0.0081	10.00	6.50
SDSL10D40F-2R5Y	2.5±30%	0.1V/100K	0.0105	7.50	6.10
SDSL10D40F-3R8Y	3.8±30%	0.1V/100K	0.0130	6.00	5.50
SDSL10D40F-5R2Y	5.2±30%	0.1V/100K	0.0220	5.50	5.40
SDSL10D40F-7R0Y	7.0±30%	0.1V/100K	0.0270	4.80	4.50
SDSL10D40F-100M	10±20%	0.1V/100K	0.0350	4.40	3.80
SDSL10D40F-150M	15±20%	0.1V/100K	0.0500	3.60	3.10
SDSL10D40F-220M	22±20%	0.1V/100K	0.0730	2.90	2.50
SDSL10D40F-330M	33±20%	0.1V/100K	0.0930	2.30	2.20
SDSL10D40F-470M	47±20%	0.1V/100K	0.1550	2.10	1.90
SDSL10D40F-101M	100±20%	0.1V/100K	0.3040	1.35	1.25
SDSL10D40F-221M	220±20%	0.1V/100K	0.7560	0.92	0.70
SDSL10D40F-331M	330±20%	0.1V/100K	1.0900	0.70	0.52

Note:

1. All test data referenced to 25°C ambient.
2. Heat Rated Current (I_{rms}) will cause the coil temperature rise approximately Δt of 40°C
3. Saturation Current (I_{sat}) will cause L₀ to drop 30% typical.

■ DC Bias Characteristics (Typical)

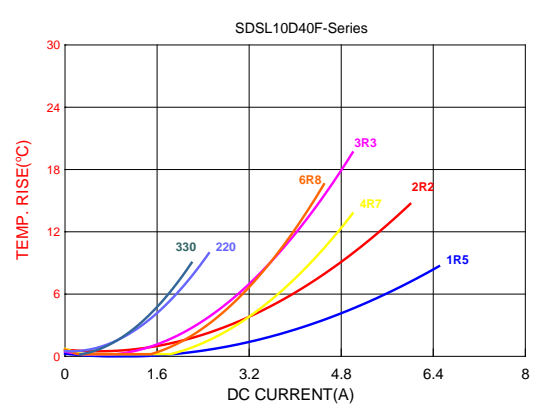
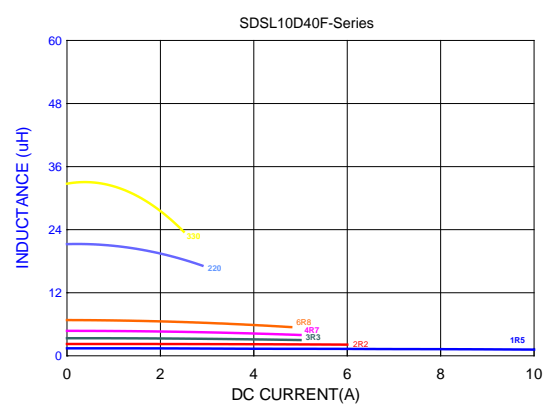

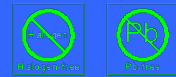

■ Dimensions

Chip Size	
A	10.20±0.30
B	10.00±0.30
C	5.00max
D	3.00±0.10
E	1.20±0.15
F	7.70±0.30

Units: mm

■ Specifications

Part Number	Inductance (uH)	Test Frequency (Hz)	DCR (mΩ) max	I sat (A) max	I rms (A) typ
SDSL10D50F-R80Y	0.8±30%	0.1V/100K	4.30	9.50	13.50
SDSL10D50F-1R5Y	1.5±30%	0.1V/100K	5.80	8.30	10.50
SDSL10D50F-2R2Y	2.2±30%	0.1V/100K	7.20	7.50	9.25
SDSL10D50F-3R3Y	3.3±30%	0.1V/100K	10.40	6.50	7.80
SDSL10D50F-4R7Y	4.7±30%	0.1V/100K	12.30	6.10	6.40
SDSL10D50F-6R8Y	6.8±30%	0.1V/100K	18.00	5.40	5.40
SDSL10D50F-100M	10±20%	0.1V/100K	26.00	4.50	4.45
SDSL10D50F-220M	22±20%	0.1V/100K	61.00	2.90	2.95
SDSL10D50F-470M	47±20%	0.1V/100K	130.0	2.00	2.00
SDSL10D50F-680M	68±20%	0.1V/100K	201.0	1.60	1.65
SDSL10D50F-101M	100±20%	0.1V/100K	253.0	1.35	1.35
SDSL10D50F-121M	120±20%	0.1V/100K	303.0	1.18	1.28

Note:

1. All test data referenced to 25°C ambient.
2. Heat Rated Current (I_{rms}) will cause the coil temperature rise approximately Δt of 40°C
3. Saturation Current (I_{sat}) will cause L₀ to drop 30% typical.

■ DC Bias Characteristics (Typical)

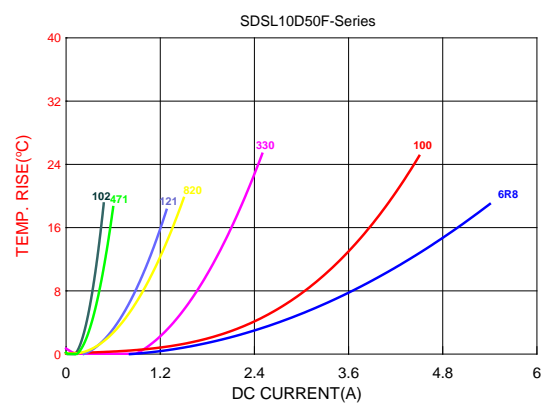
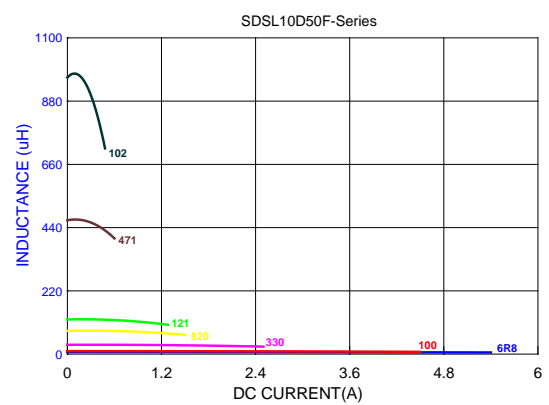

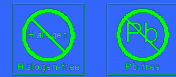

■ Dimensions

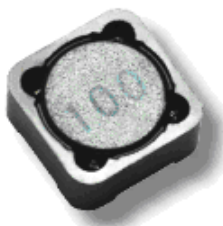
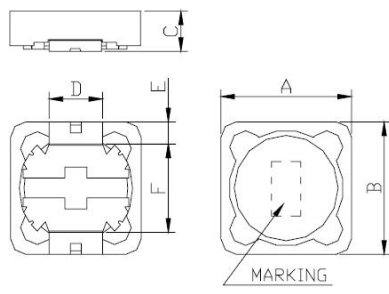
Chip Size	
A	12.80 max..
B	12.80 max..
C	5.00 max..
D	5.00 ref.
E	2.20 ref.
F	7.60 ref.

Units: mm

■ Specifications

Part Number	Inductance (uH)	Tolerance (%)	Test Frequency (Hz)	DCR (Ω) max.	IDC (A) max
TPRHC 1204F-3R9Y	3.9	± 30%	1V/100K	0.015	6.50
TPRHC 1204F-4R7Y	4.7	± 30%	1V/100K	0.018	5.70
TPRHC 1204F-6R8Y	6.8	± 30%	1V/100K	0.023	4.90
TPRHC 1204F-8R2Y	8.2	± 30%	1V/100K	0.026	4.60
TPRHC 1204F-100M	10	± 20%	1V/100K	0.028	4.50
TPRHC 1204F-220M	22	± 20%	1V/100K	0.07	2.90
TPRHC 1204F-330M	33	± 20%	1V/100K	0.097	2.70
TPRHC 1204F-470M	47	± 20%	1V/100K	0.160	1.90
TPRHC 1204F-560M	56	± 20%	1V/100K	0.190	1.80
TPRHC 1204F-680M	68	± 20%	1V/100K	0.220	1.50
TPRHC 1204F-101M	100	± 20%	1V/100K	0.308	1.20
TPRHC 1204F-221M	220	± 20%	1V/100K	0.700	0.80
TPRHC 1204F-331M	330	± 20%	1V/100K	0.990	0.50

Note:

Based on inductance change ($\Delta L/L0 : \leq -35\%$) @ ambient temp. 25°C

Based on temperature rise ($\Delta T : 40^\circ\text{C}$ typ.)

■ DC Dias Characteristics (Typical)

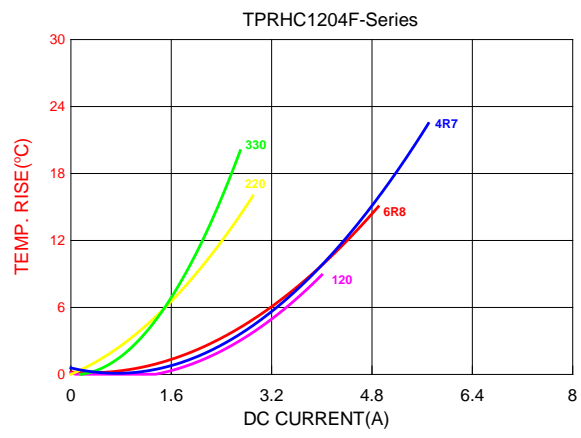
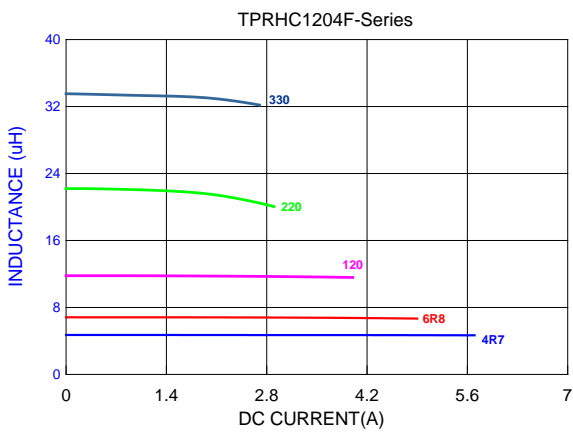

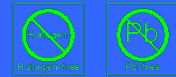

■ Dimensions

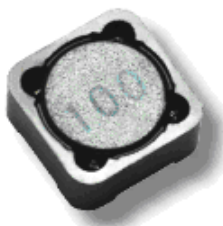

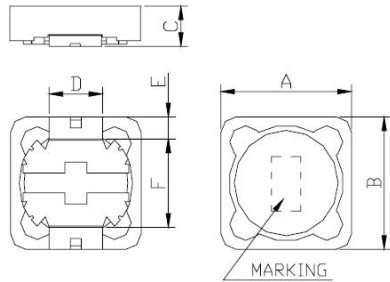

Chip Size	
A	12.80 max..
B	12.80 max..
C	6.00 max..
D	5.00 ref.
E	2.20 ref.
F	7.60 ref.

Units: mm

■ Specifications

Part Number	Inductance (uH)	Tolerance (%)	Test Frequency (Hz)	DCR (Ω) max.	IDC (A) max
TPRHC 1205F-1R3Y	1.3	± 30%	1V/100K	0.012	8.00
TPRHC 1205F-2R1Y	2.1	± 30%	1V/100K	0.014	7.00
TPRHC 1205F-3R1Y	3.1	± 30%	1V/100K	0.017	6.00
TPRHC 1205F-4R4Y	4.4	± 30%	1V/100K	0.020	5.00
TPRHC 1205F-5R8Y	5.8	± 30%	1V/100K	0.021	4.40
TPRHC 1205F-100M	10	± 20%	1V/1K	0.025	4.00
TPRHC 1205F-220M	22	± 20%	1V/1K	0.036	2.80
TPRHC 1205F-330M	33	± 20%	1V/1K	0.057	2.10
TPRHC 1205F-470M	47	± 20%	1V/1K	0.075	1.80
TPRHC 1205F-680M	68	± 20%	1V/1K	0.120	1.50
TPRHC 1205F-101M	100	± 20%	1V/1K	0.160	1.30
TPRHC 1205F-221M	220	± 20%	1V/1K	0.400	0.80
TPRHC 1205F-331M	330	± 20%	1V/1K	0.510	0.68
TPRHC 1205F-471M	470	± 20%	1V/1K	0.770	0.58
TPRHC 1205F-681M	680	± 20%	1V/1K	1.200	0.48
TPRHC 1205F-102M	1000	± 20%	1V/1K	1.530	0.40

Note:

Based on inductance change ($\Delta L/L0 : \leq -35\%$) @ ambient temp. 25°C

Based on temperature rise ($\Delta T : 40^\circ\text{C}$ typ.)

■ DC Dias Characteristics (Typical)

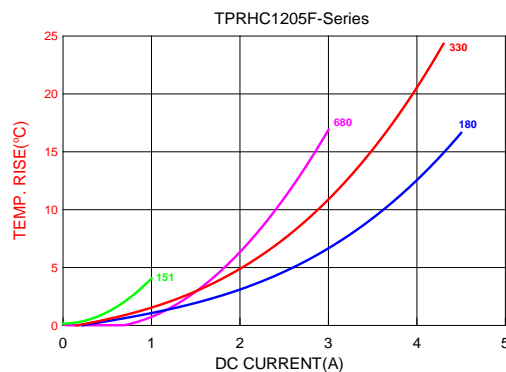
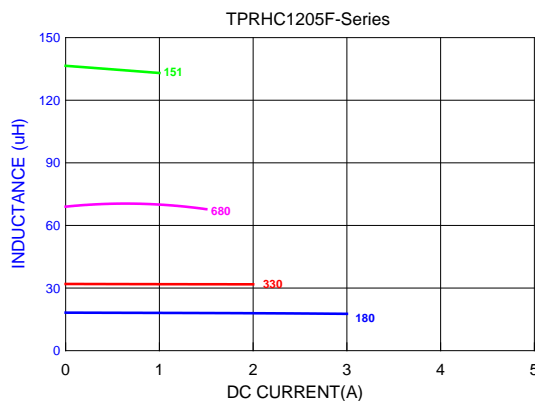

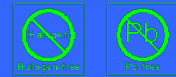

■ Dimensions

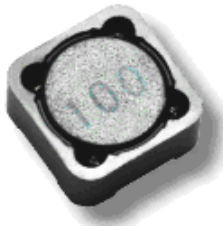
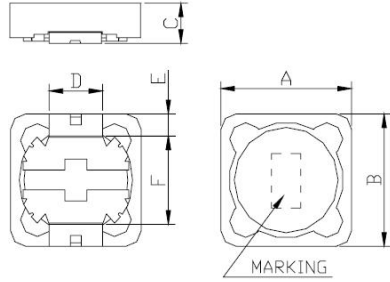
Chip Size	
A	12.80 max..
B	12.80 max..
C	8.50 max..
D	5.00 ref.
E	2.20 ref.
F	7.60 ref.

Units: mm

■ Specifications

Part Number	Inductance (uH)	Tolerance (%)	Test Frequency (Hz)	DCR (Ω) max.	IDC (A) max
TPRHC 1207F-1R2Y	1.2	± 30%	1V/100K	0.0070	9.80
TPRHC 1207F-2R4Y	2.4	± 30%	1V/100K	0.0115	8.00
TPRHC 1207F-3R5Y	3.5	± 30%	1V/100K	0.0135	7.50
TPRHC 1207F-4R7Y	4.7	± 30%	1V/100K	0.0158	6.80
TPRHC 1207F-6R1Y	6.1	± 30%	1V/100K	0.0176	6.60
TPRHC 1207F-100M	10	± 20%	1V/1K	0.0216	5.40
TPRHC 1207F-220M	22	± 20%	1V/1K	0.0432	3.60
TPRHC 1207F-330M	33	± 20%	1V/1K	0.0648	3.00
TPRHC 1207F-470M	47	± 20%	1V/1K	0.1000	2.50
TPRHC 1207F-680M	68	± 20%	1V/1K	0.1400	2.10
TPRHC 1207F-101M	100	± 20%	1V/1K	0.2200	1.70
TPRHC 1207F-221M	220	± 20%	1V/1K	0.3900	1.16
TPRHC 1207F-331M	330	± 20%	1V/1K	0.6400	0.95
TPRHC 1207F-471M	470	± 20%	1V/1K	0.9800	0.79
TPRHC 1207F-681M	680	± 20%	1V/1K	1.4600	0.67
TPRHC 1207F-102M	1000	± 20%	1V/1K	1.8200	0.55

Note:

Based on inductance change ($\Delta L/L0 : \leq -35\%$) @ ambient temp. 25°C

Based on temperature rise ($\Delta T : 40^\circ\text{C}$ typ.)

■ DC Bias Characteristics (Typical)

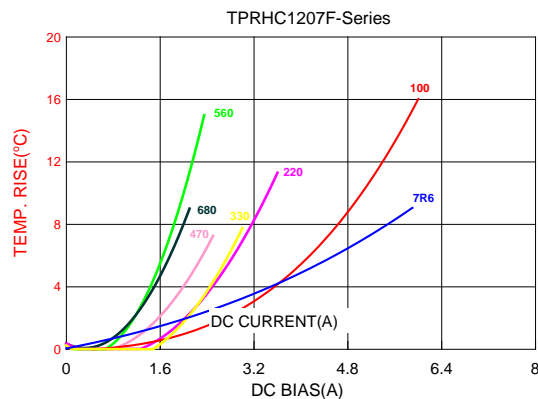
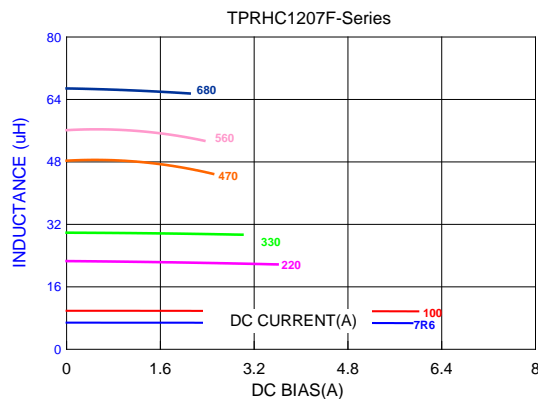





Hi-Current Power Inductors

- **Assembly Type High Current Power Inductors**
 - SLPI Series 181

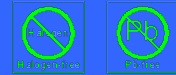
- **Molding Type High Current Power Inductors**
 - AWP Series 186
 - TMPC Series 198
 - TMPA Series 220
 - TMPF Series 234

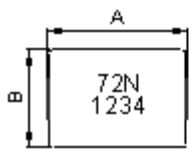
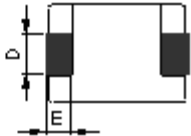

■ Dimensions

Chip Size	
A	7.00 Max
B	7.00 Max
C	4.96 Max.
D	2.49±0.25
E	1.52±0.25

Units: mm

■ Specifications

Part Number	Inductance (uH)	Tolerance (%)	Test Frequency (Hz)	DCR (Ω) max.	I sat (A) max	I rms (A) max
SLPI 070705MT-72NM-M32	0.072	±20%	0.25V/1M	0.32	58	31
SLPI 070705MT-R10M-M32	0.105	±20%	0.25V/1M	0.32	46	31
SLPI 070705MT-R15M-M32	0.150	±20%	0.25V/1M	0.32	30	24

Note :

1. Operating temperature -40°C ~ +125°C.
2. All test data is referenced to 25°C ambient.
3. I_{rms} (A) current will cause coil temperature rise approximately ΔT=40°C.
4. I_{sat} (A) current will cause L0 to drop approximately 20%.
5. The part temperature (ambient + temp rise) should not exceed 125°C under worst case operating conditions.

■ DC Bias Characteristics (Typical)

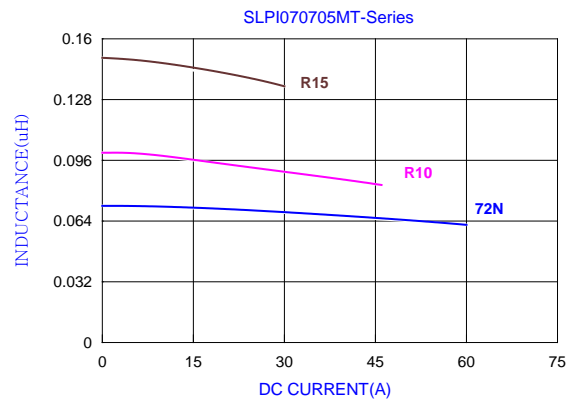
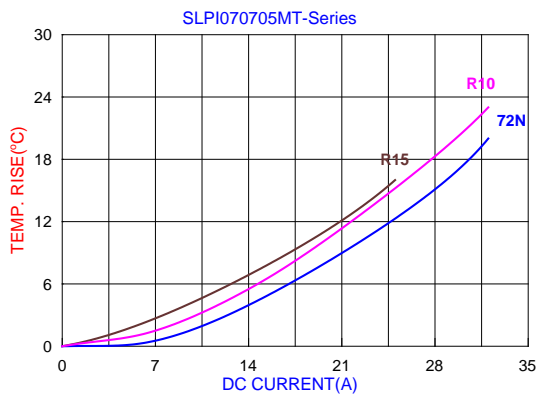

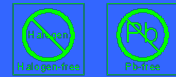

■ Dimensions

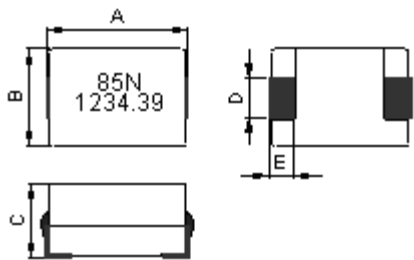
Chip Size	
A	10.20 Max
B	7.00 Max
C	4.96 Max.
D	2.49±0.25
E	1.52±0.25

Units: mm

■ Specifications

Part Number	Inductance (uH)	Tolerance (%)	Test Frequency (Hz)	DCR (Ω) max.	I sat (A) max	I rms (A) max
SLPI 100705MT-85NM-M39	0.085	±20%	0.25V/1M	0.39	70	31
SLPI 100705MT-R10M-M39	0.100	±20%	0.25V/1M	0.39	70	31
SLPI 100705MT-R12M-M39	0.120	±20%	0.25V/1M	0.39	52	31
SLPI 100705MT-R15M-M39	0.155	±20%	0.25V/1M	0.39	40	31
SLPI 100705MT-R22M-M39	0.220	±20%	0.25V/1M	0.39	33	25

Note :

1. Operating temperature -40°C ~ +125°C.
2. All test data is referenced to 25°C ambient.
3. I_{rms} (A) current will cause coil temperature rise approximately ΔT=40°C.
4. I_{sat} (A) current will cause L₀ to drop approximately 20% .
5. The part temperature (ambient + temp rise) should not exceed 125°C under worst case operating conditions.

■ DC Bias Characteristics (Typical)

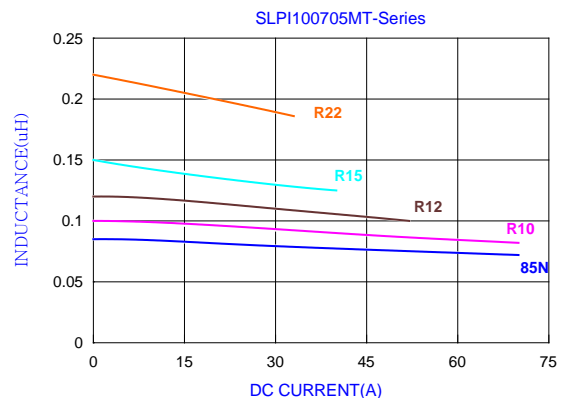
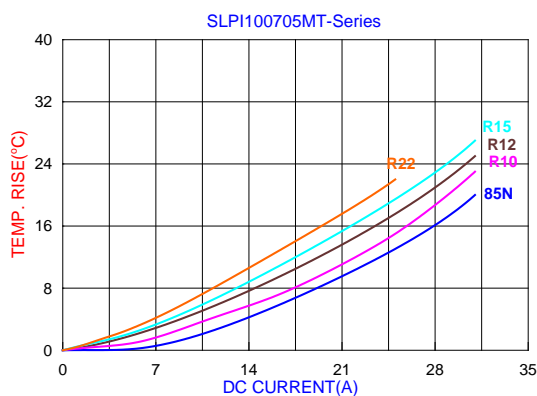

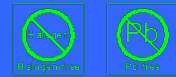

■ Dimensions

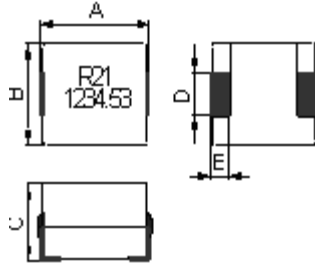
Chip Size	
A	13.46 Max
B	12.95 Max
C	8.00 Max.
D	5.08 ± 0.25
E	2.54 ± 0.25

Units: mm

■ Specifications

Part Number	Inductance (uH)	Tolerance (%)	Test Frequency (Hz)	DCR (Ω) max.	I sat (A) max	I rms (A) max
SLPI 131308MT-R21M-M53	0.21	±20%	0.25V/1M	0.53	71	45
SLPI 131308MT-R26M-M53	0.26	±20%	0.25V/1M	0.53	60	45
SLPI 131308MT-R32M-M53	0.32	±20%	0.25V/1M	0.53	50	41
SLPI 131308MT-R44M-M53	0.44	±20%	0.25V/1M	0.53	35	30

Note :

1. Operating temperature -40°C ~ +125°C.
2. All test data is referenced to 25°C ambient.
3. I_{rms} (A) current will cause coil temperature rise approximately ΔT=40°C.
4. I_{sat} (A) current will cause L0 to drop approximately 20% .
5. The part temperature (ambient + temp rise) should not exceed 125°C under worst case operating conditions.

■ DC Bias Characteristics (Typical)

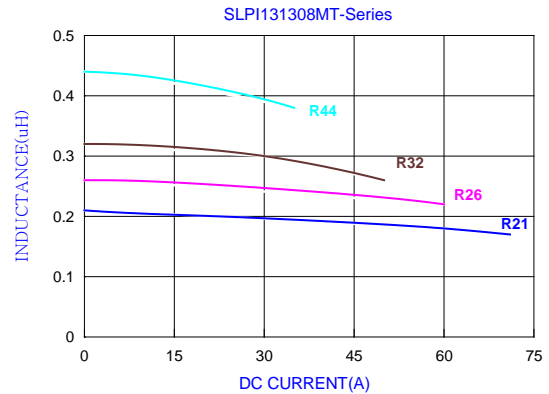
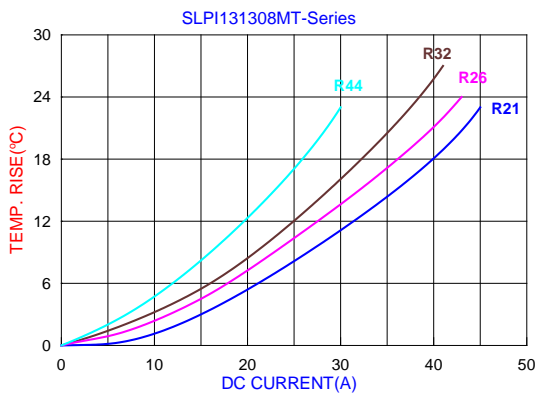

SLPI361108P4-Series-M28 (14444 inch)

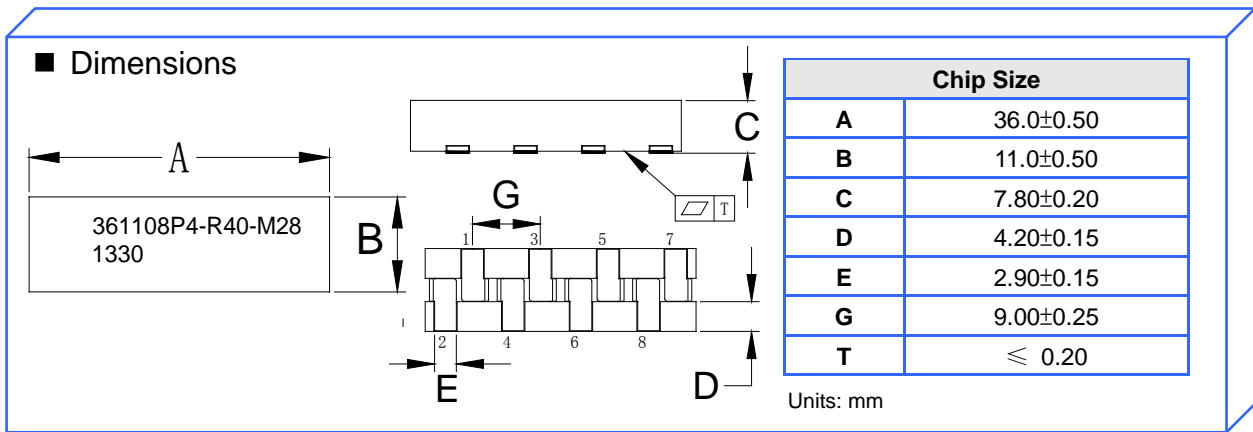
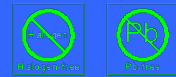

■ Specifications

Functional						Test				
Part Number	Inductor Phases	DCR (mΩ) @25°C	Rated Inductance Per Phase (uH)	I Rated per Phase (Adc)	I max Peak per Phase (Adc)	Pin No.	OCL (uH)	Pin No.	OCL (uH)	Magnetized Inductance (uH)@ 10Adc (25°C)
SLPI361108P4-R40M-M28	4	0.28 ± 10%	0.05±20%	50	80	(3-4), (5-6)	0.40 ± 20%	(1-2), (7-8)	0.38 ± 20%	0.30

Note:

1. Testing frequency: 1MHz/0.1v.
2. Testing Instrument: L: HP4284A, CH3302, CH1320, CH-1320S LCR METER /Dcr: HIOKI3540/CH502B.
3. Operating temperature -40°C ~ +125°C
4. All test data is referenced to 25°C ambient.
5. The rated current, I_{max} peak current, and rated inductance per phase is determined by Volterra's testing and circuit design, Additional information can be provided by contacting Volterra.



SLPI451108P5-Series-M28 (18044 inch)



■ Dimensions

Chip Size	
A	45.0±0.80
B	11.0±0.50
C	7.80±0.20
D	4.20±0.15
E	2.90±0.15
G	9.00±0.25
T	≤ 0.20

Units: mm

■ Specifications

Functional						Test				
Part Number	Inductor Phases	DCR (mΩ) @25°C	Rated Inductance Per Phase ±20% (uH)	I Rated per Phase (Adc)	I max Peak per Phase (Adc)	Pin No.	OCL (uH)	Pin No.	OCL (uH)	Magnetized Inductance (uH)@ 10Adc (25°C)
SLPI451108P5-R40M-M28	5	0.28 ± 10%	0.05	50	80	(3-4), (5-6), (7-8)	0.40 ± 20%	(1-2), (9-10)	0.38 ± 20%	0.30

Note:

1. Testing frequency: 1MHz/0.1v.
2. Testing Instrument: L: HP4284A, CH3302, CH1320, CH-1320S LCR METER /Dcr: HIOKI3540/CH502B.
3. Operating temperature -40°C ~ +125°C
4. All test data is referenced to 25°C ambient.
5. The rated current, I_{max} peak current, and rated inductance per phase is determined by Volterra's testing and circuit design. Additional information can be provided by contacting Volterra.



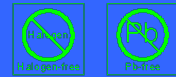

■ Dimensions

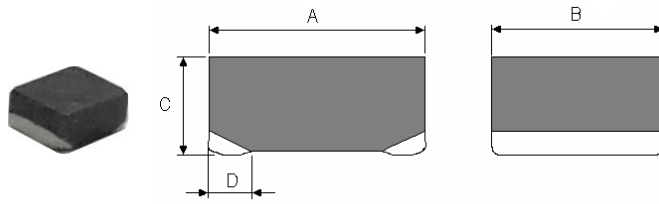

Dimensions	
A	2.00±0.20
B	1.60±0.20
C	1.00 max.
D	0.50±0.30

Units:mm

■ Specifications

TAI-TECH Part Number	Inductance (uH)	Test Frequency (Hz)	DCR (Ω)		I sat (A)		I rms (A)	
			max.	typ.	max.	typ.	max.	typ.
AWP201610AF-R24M	0.24±20%	1V/1M	0.048	0.040	4.20	4.70	3.00	3.30
AWP201610AF-R47M	0.47±20%	1V/1M	0.053	0.044	2.70	3.60	2.80	3.00
AWP201610AF-R68M	0.68±20%	1V/1M	0.073	0.061	2.35	2.60	2.35	2.90
AWP201610AF-1R0M	1.0±20%	1V/1M	0.084	0.070	2.20	2.50	2.20	2.50
AWP201610AF-1R5M	1.5±20%	1V/1M	0.138	0.115	1.60	1.90	1.65	1.90
AWP201610AF-2R2M	2.2±20%	1V/1M	0.186	0.155	1.50	1.80	1.50	1.60
AWP201610AF-3R3M	3.3±20%	1V/1M	0.276	0.230	1.15	1.40	1.20	1.45
AWP201610AF-4R7M	4.7±20%	1V/1M	0.396	0.330	1.00	1.20	0.95	1.15

Note:

Isat : Based on inductance change ($\Delta L/L0 : \cong -30\%$) @ ambient temp. 25°C

Irms : Based on temperature rise ($\Delta T : 40^\circ\text{C}.$) Max

■ Inductance-Frequency, DC Dias Characteristics (Typical)

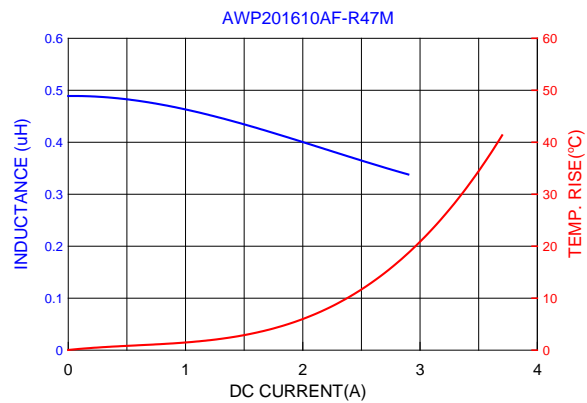
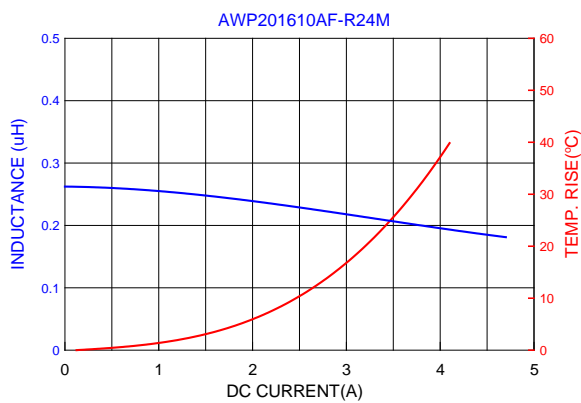

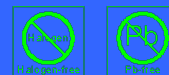

■ Inductance-Frequency, DC Bias Characteristics (Typical)

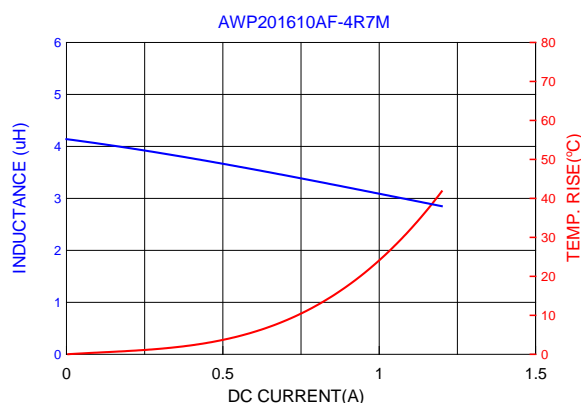
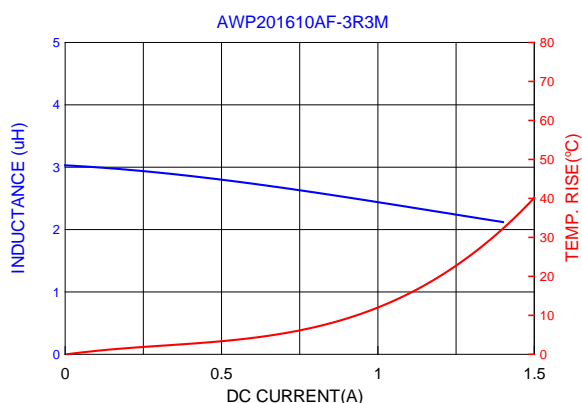
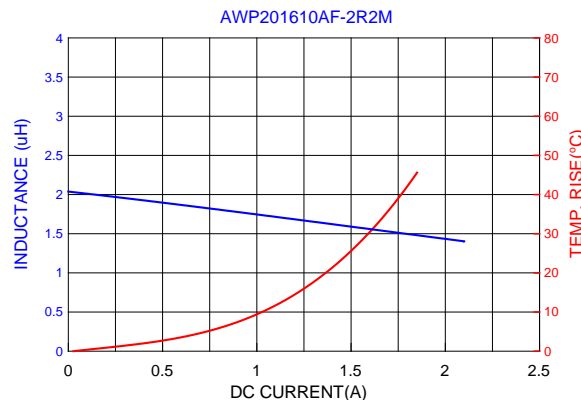
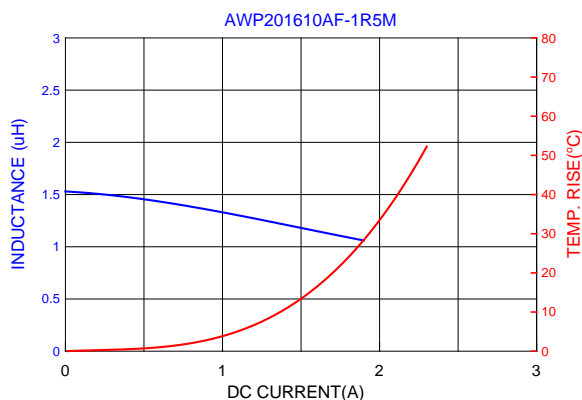
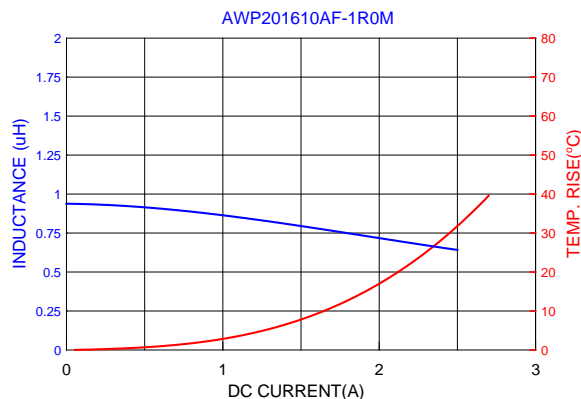
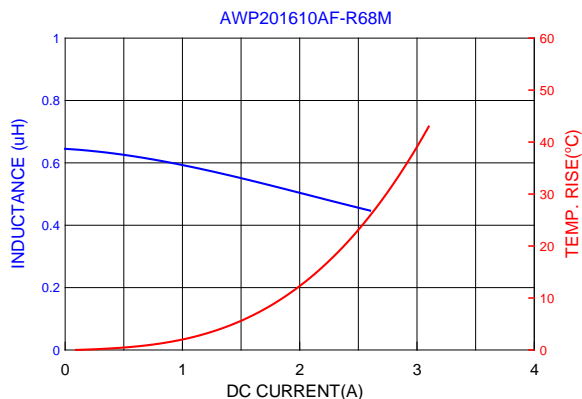

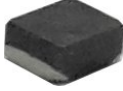
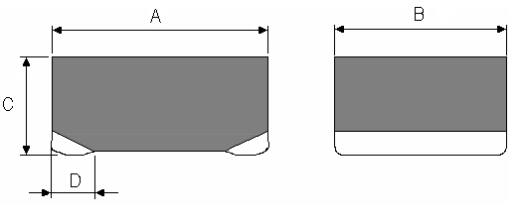

■ Dimensions

Dimensions	
A	2.50±0.20
B	2.00±0.20
C	1.00 max.
D	0.50±0.30

Units: mm

■ Specifications

TAI-TECH Part Number	Inductance (uH)	Test Frequency (Hz)	DCR (Ω)		I sat (A)		I rms (A)	
			max.	typ.	max.	typ.	max.	typ.
AWP252010AF-R47M	0.47±20%	1V/1M	0.048	0.040	4.00	4.50	3.20	3.60
AWP252010AF-R68M	0.68±20%	1V/1M	0.070	0.058	3.70	4.00	2.90	3.20
AWP252010AF-1R0M	1.0±20%	1V/1M	0.079	0.066	2.70	3.00	2.50	2.70
AWP252010AF-2R2M	2.2±20%	1V/1M	0.168	0.140	1.90	2.10	1.50	1.80
AWP252010AF-4R7M	4.7±20%	1V/1M	0.324	0.270	1.30	1.50	1.10	1.30

Note:

I_{sat} : Based on inductance change (ΔL/L₀ : ≦-30%) @ ambient temp. 25°C

I_{rms} : Based on temperature rise (ΔT : 40°C.) Max

■ Inductance-Frequency, DC Dias Characteristics (Typical)

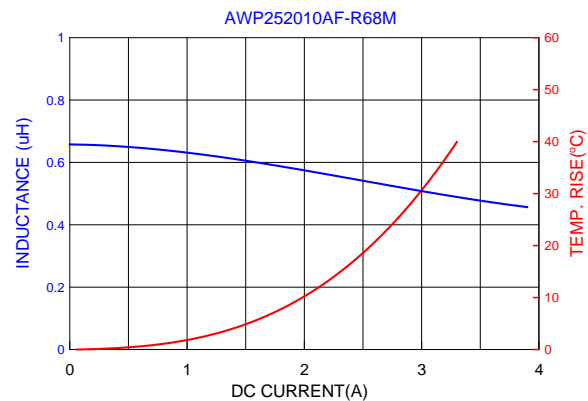
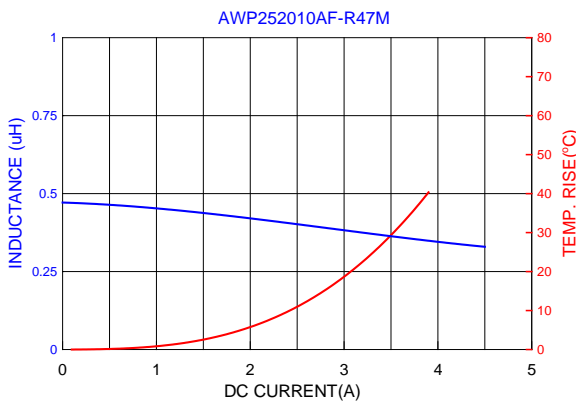



■ Inductance-Frequency, DC Bias Characteristics (Typical)

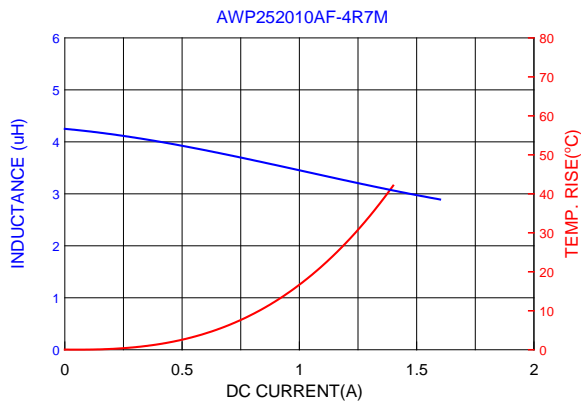
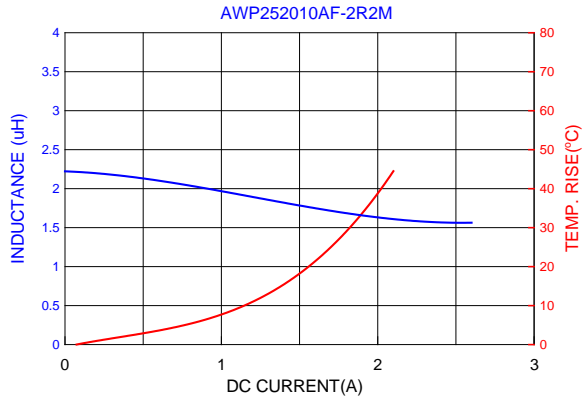
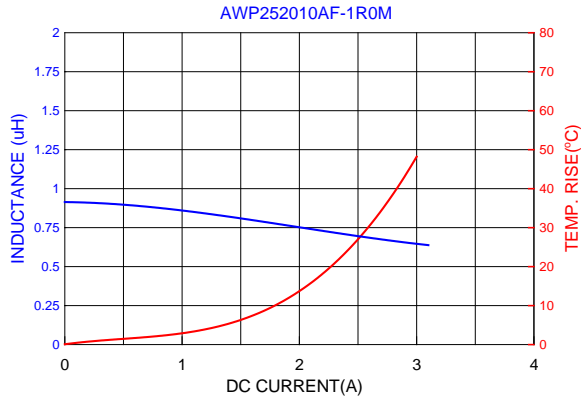

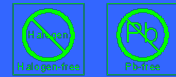

■ Dimensions

Dimensions	
A	2.50±0.20
B	2.00±0.20
C	1.20 max.
D	0.50±0.30

Units: mm

■ Specifications

TAI-TECH Part Number	Inductance (uH)	Test Frequency (Hz)	DCR (Ω)		I sat (A)		I rms (A)	
			max.	typ.	max.	typ.	max.	typ.
AWP252012AF-R47M	0.47±20%	1V/1M	0.039	0.029	4.00	4.50	3.50	3.80
AWP252012AF-R68M	0.68±20%	1V/1M	0.056	0.046	3.10	3.50	3.00	3.30
AWP252012AF-1R0M	1.0±20%	1V/1M	0.065	0.054	2.70	3.00	2.70	2.90
AWP252012AF-2R2M	2.2±20%	1V/1M	0.125	0.104	2.20	2.50	2.00	2.20
AWP252012AF-3R3M	3.3±20%	1V/1M	0.167	0.139	1.70	1.90	1.70	1.90
AWP252012AF-4R7M	4.7±20%	1V/1M	0.260	0.198	1.40	1.60	1.40	1.60

Note:

I_{sat} : Based on inductance change (ΔL/L0 : ≦-30%) @ ambient temp. 25°C

I_{rms} : Based on temperature rise (ΔT : 40°C.) Max

■ Inductance-Frequency, DC Dias Characteristics (Typical)

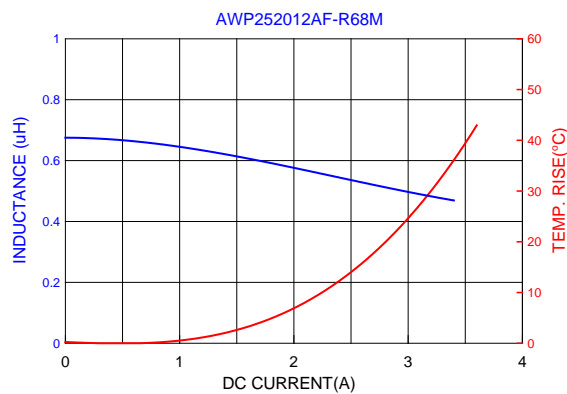
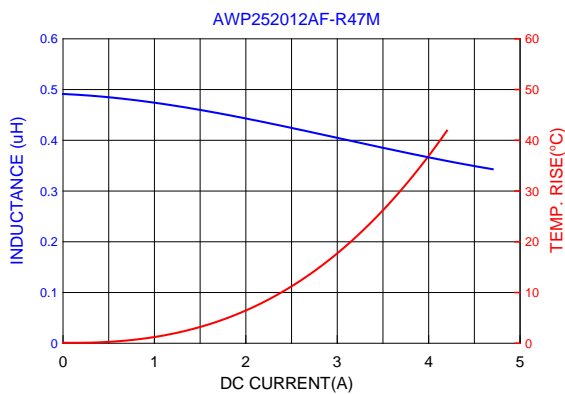



■ Inductance-Frequency, DC Bias Characteristics (Typical)

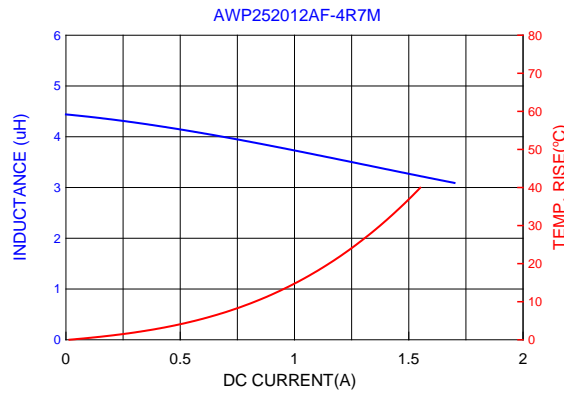
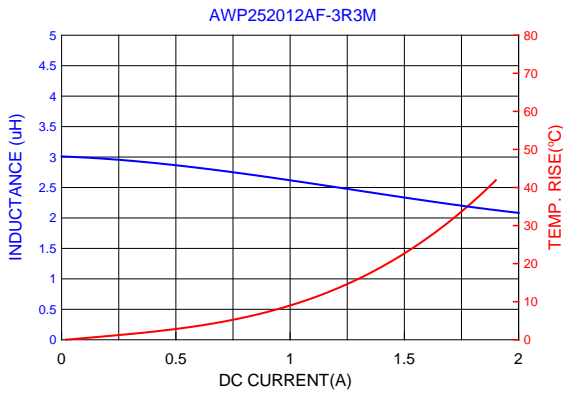
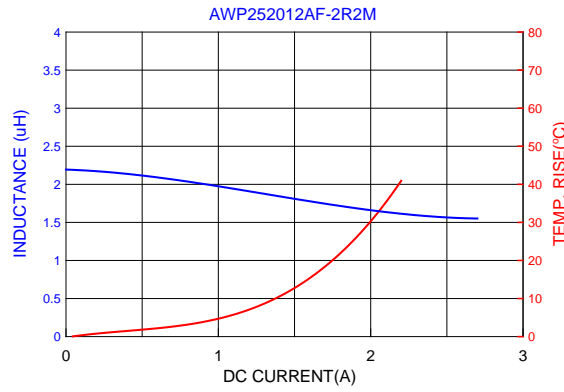
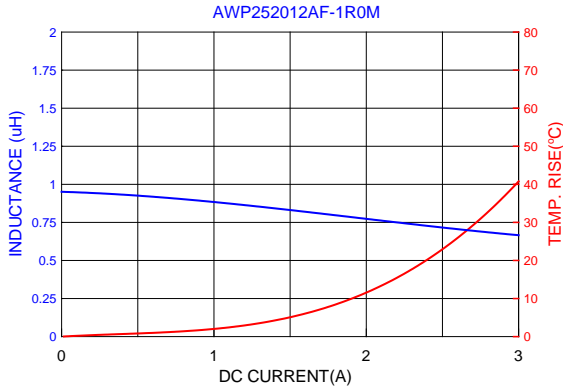

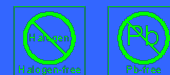

■ Dimensions

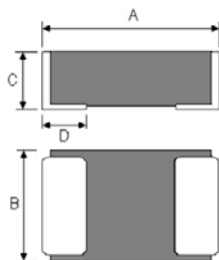

Dimensions

A	2.00±0.20
B	1.60±0.20
C	1.00 max.
D	0.50±0.30

Units: mm

■ Specifications

TAI-TECH Part Number	Inductance (uH)	Test Frequency (Hz)	DCR (Ω)		I sat (A)		I rms (A)	
			max.	typ.	max.	typ.	max.	typ.
AWP201610BF-R24M	0.24±20%	1V/1M	0.022	0.018	5.05	5.50	4.50	5.00
AWP201610BF-R33M	0.33±20%	1V/1M	0.033	0.027	4.50	5.00	3.70	4.00
AWP201610BF-R47M	0.47±20%	1V/1M	0.045	0.037	4.00	4.40	3.15	3.50
AWP201610BF-R68M	0.68±20%	1V/1M	0.054	0.045	3.30	3.60	3.00	3.30
AWP201610BF-1R0M	1.0±20%	1V/1M	0.077	0.064	2.60	2.90	2.25	2.50
AWP201610BF-1R5M	1.5±20%	1V/1M	0.144	0.120	2.25	2.40	1.65	1.90
AWP201610BF-2R2M	2.2±20%	1V/1M	0.173	0.144	1.70	1.90	1.50	1.70

Note:

I_{sat} : Based on inductance change (ΔL/L₀ : ≦ -30%) @ ambient temp. 25°C

I_{rms} : Based on temperature rise (ΔT : 40°C.) Max

■ Inductance-Frequency, DC Bias Characteristics (Typical)

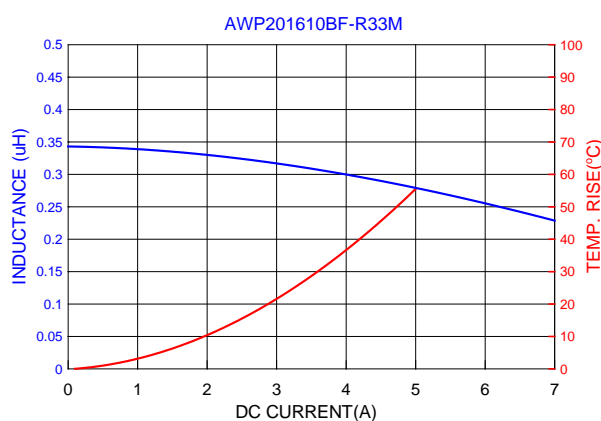
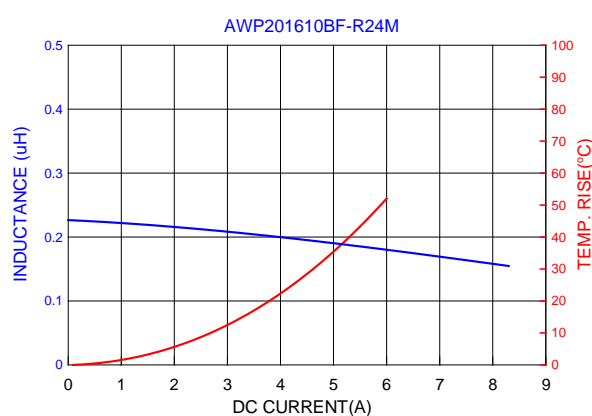



■ Inductance-Frequency, DC Bias Characteristics (Typical)

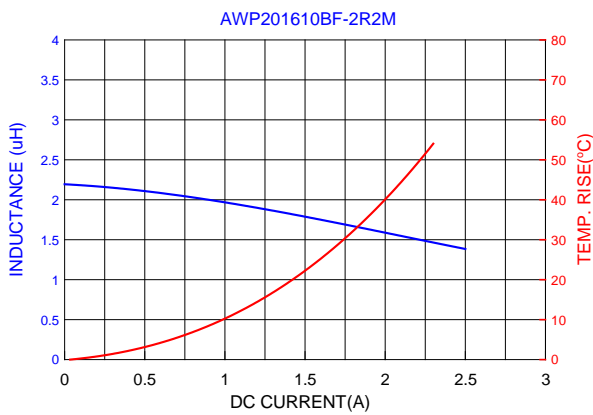
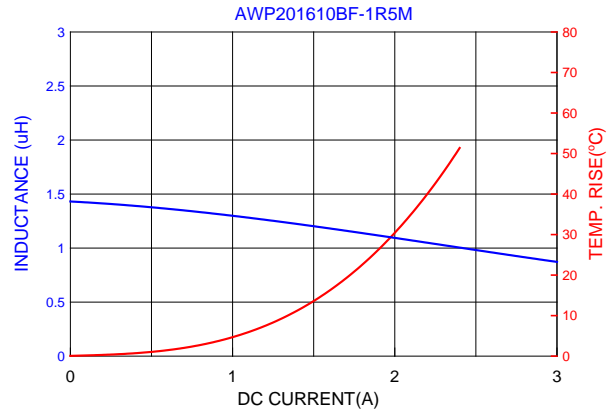
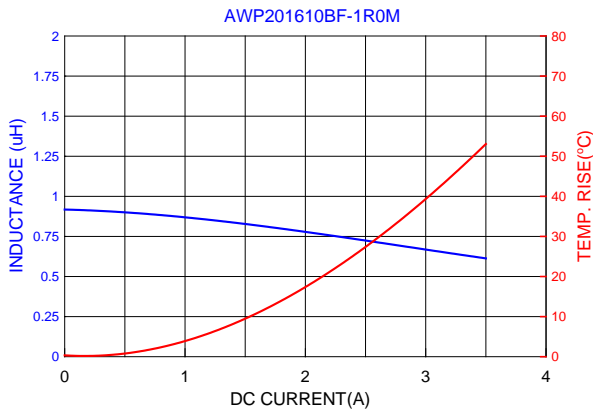
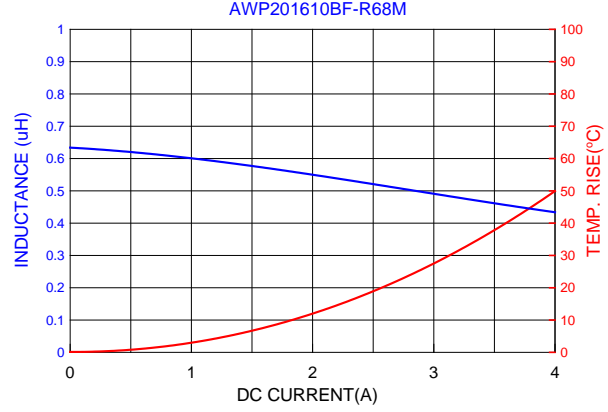
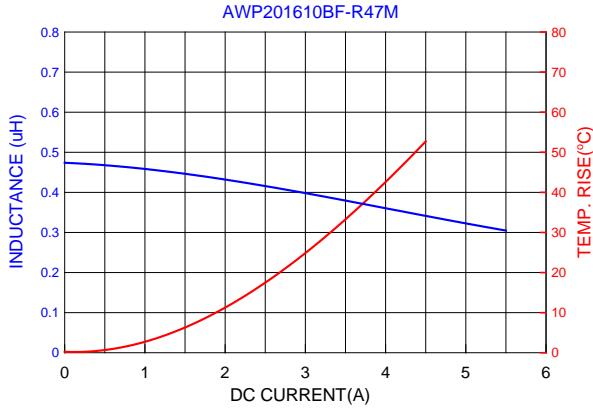

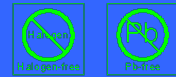

■ Dimensions

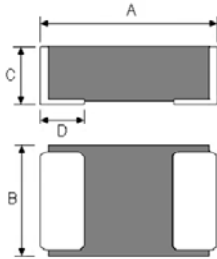

Dimensions	
A	2.50±0.20
B	2.00±0.20
C	1.00 max.
D	0.60±0.30

Units: mm

■ Specifications

TAI-TECH Part Number	Inductance (uH)	Test Frequency (Hz)	DCR (Ω)		I sat (A)		I rms (A)	
			max.	typ.	max.	typ.	max.	typ.
AWP252010IF-R22M	0.22±20%	1V/1M	0.0125	0.009	7.20	7.90	5.30	5.90
AWP252010IF-R33M	0.33±20%	1V/1M	0.026	0.021	6.00	6.60	4.00	4.40
AWP252010IF-R47M	0.47±20%	1V/1M	0.032	0.027	4.50	5.00	3.51	3.90
AWP252010IF-R68M	0.68±20%	1V/1M	0.044	0.037	3.87	4.30	3.06	3.40
AWP252010IF-1R0M	1.0±20%	1V/1M	0.054	0.045	3.15	3.50	2.70	3.00
AWP252010IF-1R5M	1.5±20%	1V/1M	0.092	0.076	2.35	2.60	2.25	2.50
AWP252010IF-2R2M	2.2±20%	1V/1M	0.130	0.108	2.15	2.30	2.05	2.30
AWP252010IF-4R7M	4.7±20%	1V/1M	0.262	0.220	1.62	1.80	1.22	1.36

Note:

I_{sat} : Based on inductance change (ΔL/L₀ : ≦-30%) @ ambient temp. 25°C

I_{rms} : Based on temperature rise (ΔT : 40°C.) Max

■ Inductance-Frequency, DC Dias Characteristics (Typical)

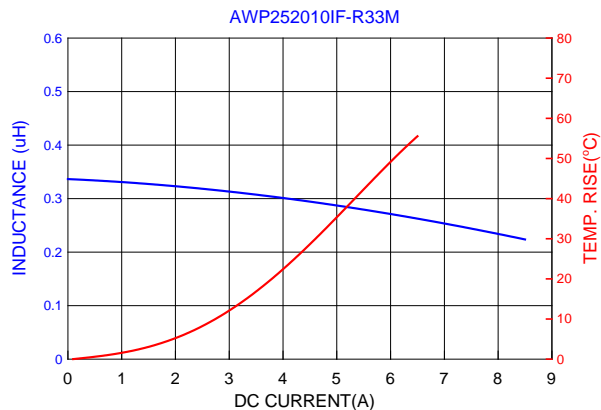
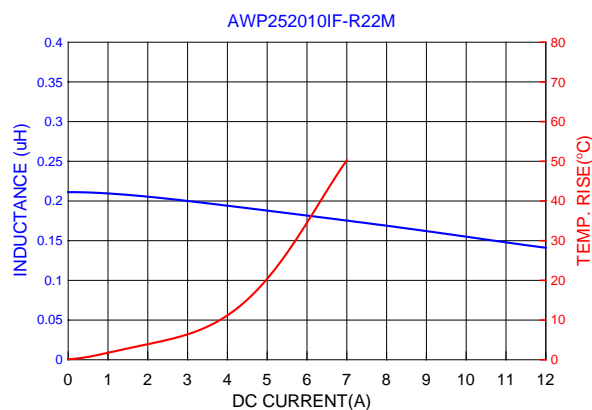



■ Inductance-Frequency, DC Bias Characteristics (Typical)

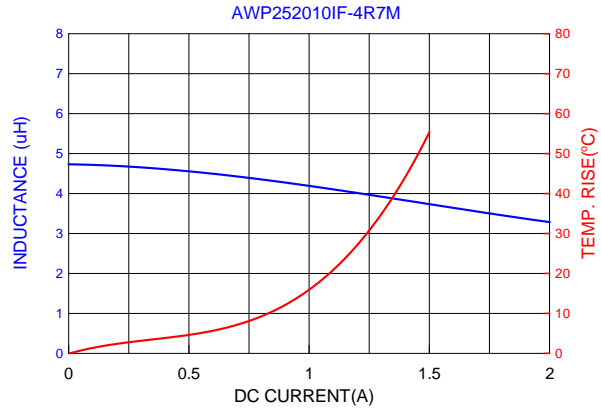
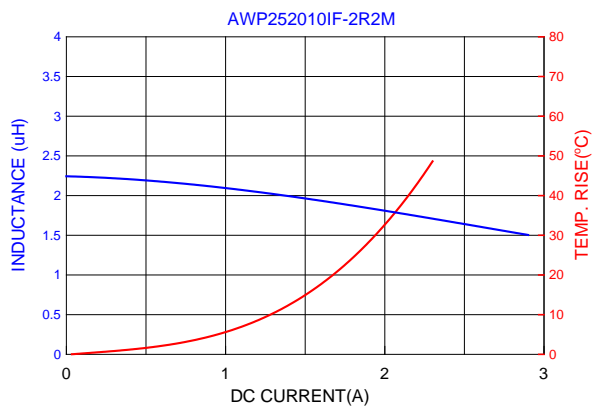
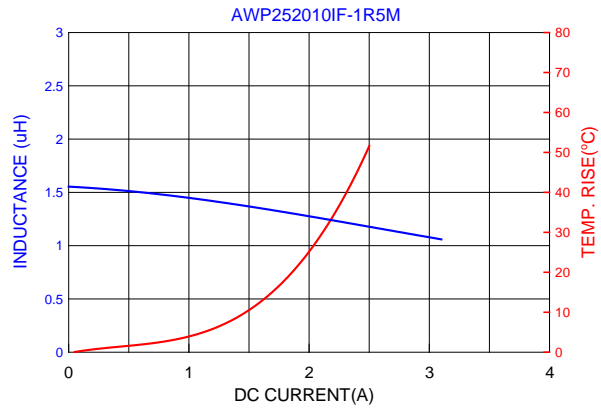
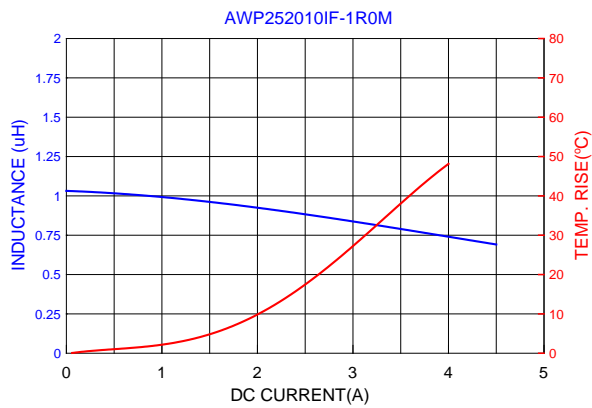
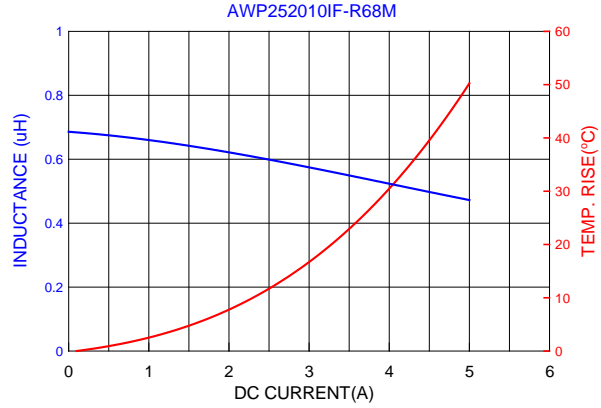
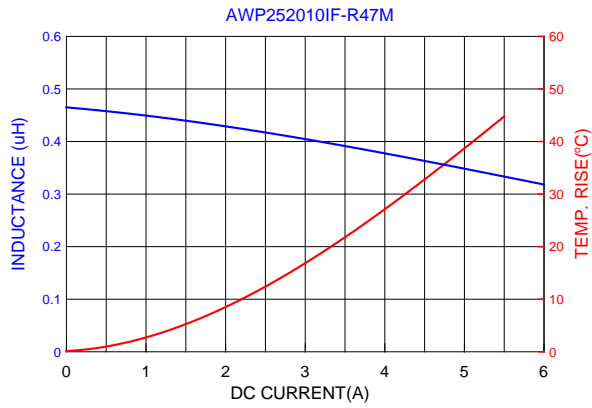

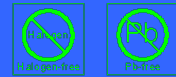

■ Dimensions

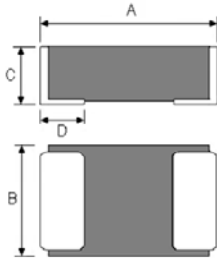

Dimensions	
A	2.50±0.20
B	2.00±0.20
C	1.20 max.
D	0.60±0.30

Units: mm

■ Specifications

TAI-TECH Part Number	Inductance (uH)	Test Frequency (Hz)	DCR (Ω)		I sat (A)		I rms (A)	
			max.	typ.	max.	typ.	max.	typ.
AWP252012IF-R47M	0.47±20%	1V/1M	0.025	0.021	4.95	5.30	4.18	4.60
AWP252012IF-R68M	0.68±20%	1V/1M	0.035	0.029	4.63	5.00	3.36	3.70
AWP252012IF-1R0M	1.0±20%	1V/1M	0.057	0.048	3.50	4.00	3.18	3.50
AWP252012IF-1R5M	1.5±20%	1V/1M	0.077	0.064	2.91	3.20	2.27	2.50
AWP252012IF-2R2M	2.2±20%	1V/1M	0.105	0.088	2.50	2.70	2.06	2.27
AWP252012IF-4R7M	4.7±20%	1V/1M	0.235	0.196	1.58	1.90	1.40	1.55

■ Inductance-Frequency, DC Dias Characteristics (Typical)

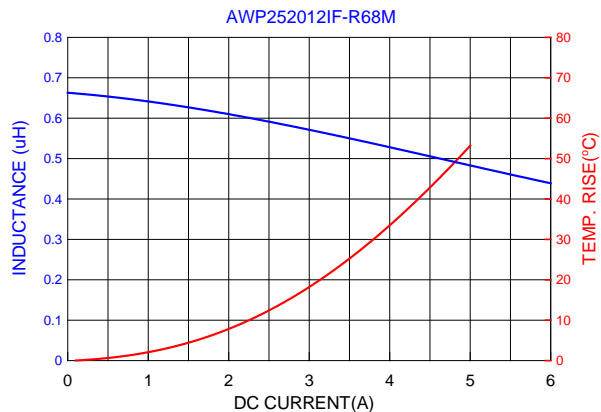
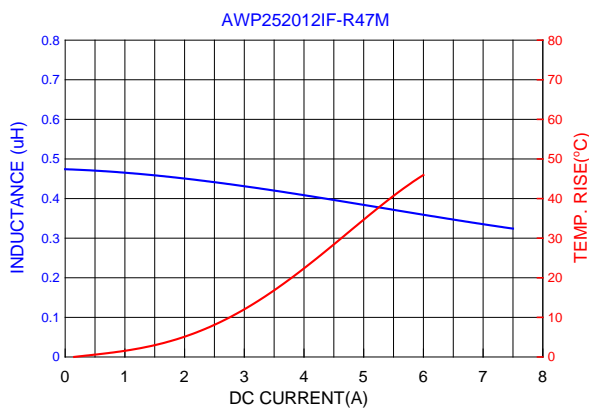



■ Inductance-Frequency, DC Bias Characteristics (Typical)

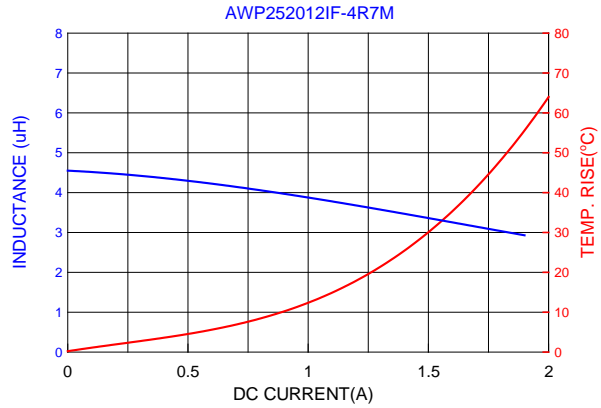
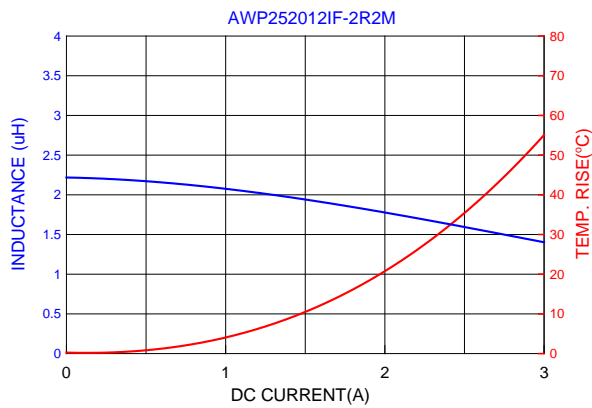
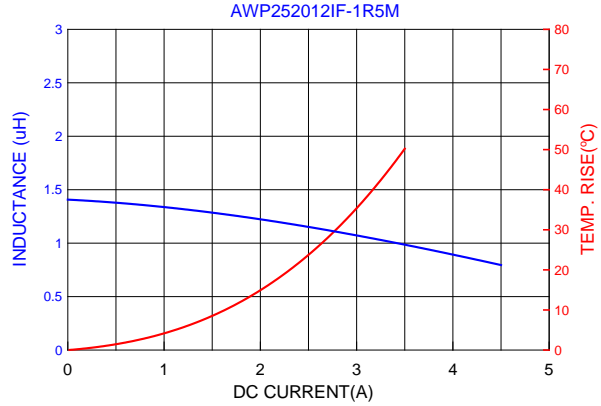
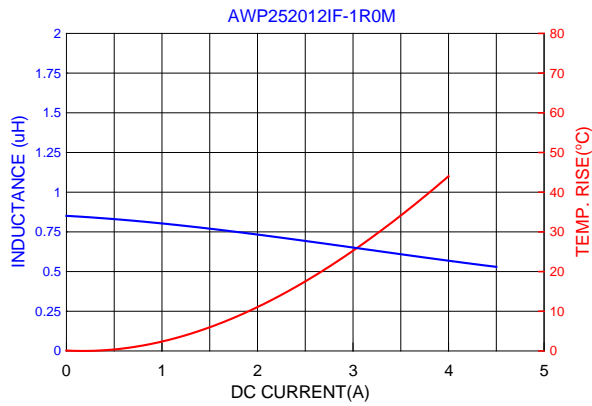

Molding Type High Current Power Inductors

TMPC 0312H Series (1212 inch)

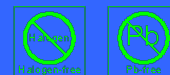

■ Dimensions

Chip Size	
A	3.50±0.20
B	3.20±0.20
C	1.00±0.20
D	0.70±0.20
E	1.20±0.20

Units: mm

■ Specifications

Part Number	Inductance L0 (uH)	I rms (A) typ.	I sat (A) typ.	DCR(mΩ) typ. @25°C	DCR(mΩ) max. @25°C
TMPC0312H-R47MG	0.47±20%	5.00	7.20	25	30
TMPC0312H-R56MG	0.56±20%	4.50	6.60	31	36
TMPC0312H-R68MG	0.68±20%	4.00	6.10	34	40
TMPC0312H-R82MG	0.82±20%	3.50	5.80	41	48
TMPC0312H-1R0MG	1.00±20%	3.30	5.50	50	60
TMPC0312H-1R5MG	1.50±20%	3.00	4.00	71	85
TMPC0312H-2R2MG	2.20±20%	2.70	3.40	98	115
TMPC0312H-3R3MG	3.30±20%	2.00	3.10	191	210
TMPC0312H-4R7MG	4.70±20%	1.60	2.80	266	293
TMPC0312H-5R6MG	5.60±20%	1.50	2.20	310	360
TMPC0312H-6R8MG	6.80±20%	1.40	2.00	360	400
TMPC0312H-8R2MG	8.20±20%	1.20	1.70	420	463
TMPC0312H-100MG	10.0±20%	1.00	1.40	498	550

Note:

1. Test frequency : L : 100KHz /1.0V.
2. All test data referenced to 25°C ambient.
3. Heat Rated Current (I_{rms}) will cause the coil temperature rise approximately Δt of 40°C
4. Saturation Current (I_{sat}) will cause L₀ to drop 30% typical.
5. Special inquiries besides the above common used types can be met on your requirement.

■ DC Bias Characteristics (Typical)

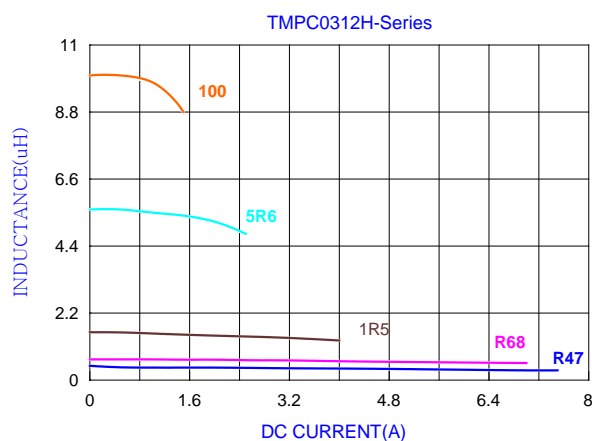
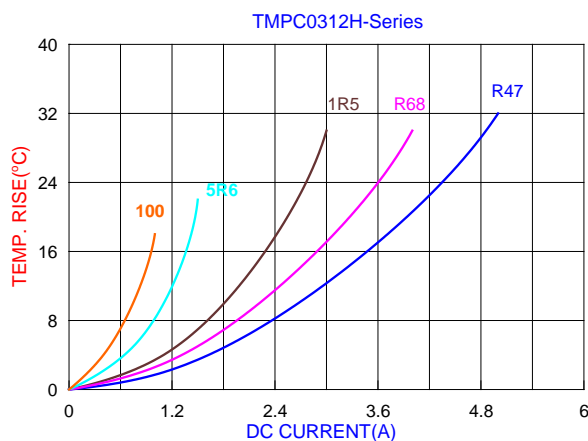

Molding Type High Current Power Inductors

TMPC 0302H Series (1212 inch)

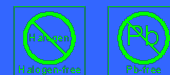

■ Dimensions

Chip Size	
A	3.50±0.20
B	3.20±0.20
C	1.80±0.20
D	0.70±0.20
E	1.20±0.20

Units: mm

■ Specifications

Part Number	Inductance L0 (uH)	I rms (A) typ.	I sat (A) typ.	DCR(mΩ) typ. @25°C	DCR(mΩ) max. @25°C
TMPC0302H-R10YG	0.10±30%	10.50	14.00	6.6	9.0
TMPC0302H-R47MG	0.47±20%	7.00	9.00	19.7	23.0
TMPC0302H-R68MG	0.68±20%	5.50	7.00	25.5	29.0
TMPC0302H-1R0MG	1.00±20%	4.00	5.00	32.0	38.0
TMPC0302H-2R2MG	2.20±20%	3.50	3.70	65.0	75.0
TMPC0302H-3R3MG	3.30±20%	3.00	3.50	125	145
TMPC0302H-4R7MG	4.70±20%	2.60	3.00	172	200
TMPC0302H-5R6MG	5.60±20%	2.20	2.60	205	238
TMPC0302H-6R8MG	6.80±20%	1.90	2.20	260	300
TMPC0302H-100MG	10.0±20%	1.40	1.60	366	422

Note:

1. Test frequency : L : 100KHz /1.0V.
2. All test data referenced to 25°C ambient.
3. Heat Rated Current (I_{rms}) will cause the coil temperature rise approximately Δt of 40°C.
4. Saturation Current (I_{sat}) will cause L₀ to drop 30% typical.
5. Special inquiries besides the above common used types can be met on your requirement.

■ DC Bias Characteristics (Typical)

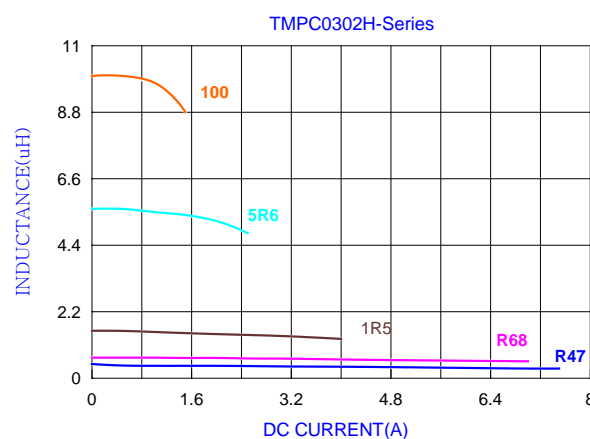
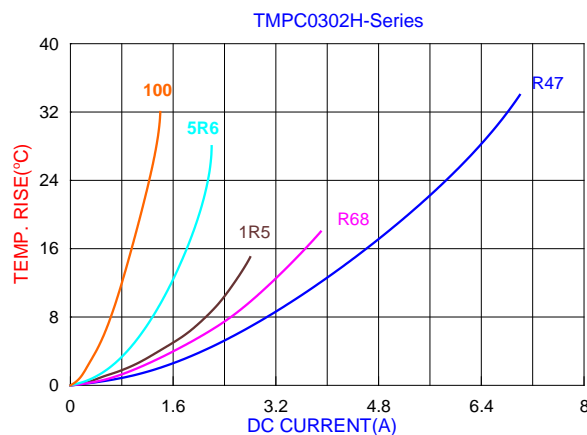

Molding Type High Current Power Inductors

TMPC 0412HP Series (1616 inch)

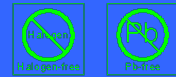

■ Dimensions

Chip Size	
A	4.45±0.25
B	4.06±0.25
C	1.00±0.20
D	0.76±0.30
E	2.00±0.20

Units: mm

■ Specifications

Part Number	Inductance L0 (uH)±20%	I rms (A)typ	I sat (A)typ	DCR (mΩ) typ. @25°C.	DCR (mΩ) max. @25°C.
TMPC0412HP-R10YG-Z02	0.10±30%	11.50	25.0	4.30	5.50
TMPC0412HP-R47MG-Z02	0.47±20%	6.00	6.50	18.0	20.0
TMPC0412HP-R68MG-Z02	0.68±20%	5.00	6.00	32.0	37.0
TMPC0412HP-1R0MG-Z02	1.00±20%	4.00	6.00	41.0	47.0
TMPC0412HP-2R2MG-Z02	2.20±20%	2.80	3.50	69.2	80.0
TMPC0412HP-3R3MG-Z02	3.30±20%	2.30	3.00	84.0	97.0
TMPC0412HP-4R7MG-Z02	4.70±20%	2.00	2.50	128	145
TMPC0412HP-5R6MG-Z02	5.60±20%	1.70	2.30	180	208
TMPC0412HP-6R8MG-Z02	6.80±20%	1.50	1.70	300	360
TMPC0412HP-100MG-Z02	10.0±20%	1.30	1.40	410	463

Note:

1. Test frequency : L : 100KHz /1.0V.
2. All test data referenced to 25°C ambient.
3. Heat Rated Current (I_{rms}) will cause the coil temperature rise approximately Δt of 40°C.
4. Saturation Current (I_{sat}) will cause L₀ to drop 30% typical.
5. Special inquiries besides the above common used types can be met on your requirement.

■ DC Bias Characteristics (Typical)

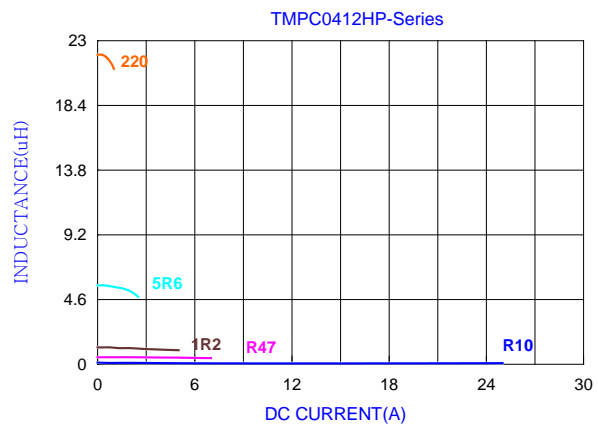
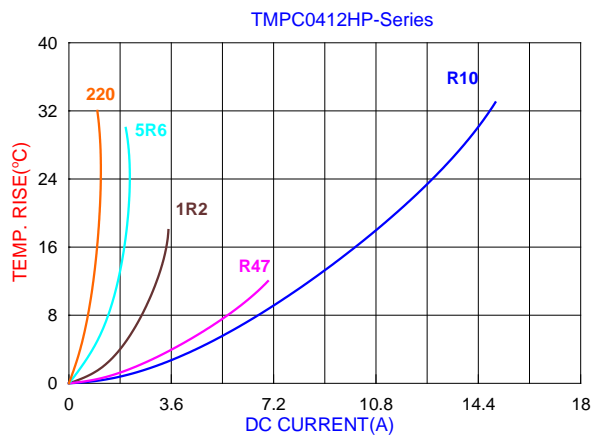

Molding Type High Current Power Inductors

TMPC 0402HP Series (1616 inch)

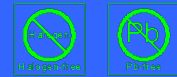

■ Dimensions

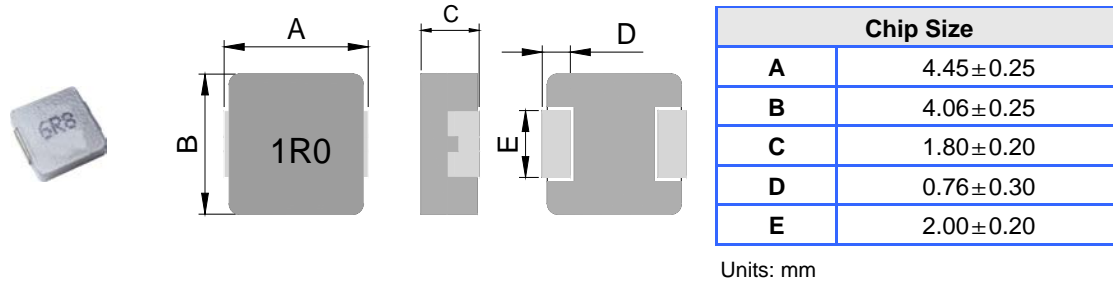

■ Specifications

Part Number	Inductance L0 (uH)±20%	I rms (A)typ	I sat (A)typ	DCR (mΩ) typ. @25°C.	DCR (mΩ) max. @25°C.
TMPC0402HP-R33MG-Z02	0.33	10.0	18.0	7.80	8.60
TMPC0402HP-R47MG-Z02	0.47	8.00	12.0	11.2	14.0
TMPC0402HP-R68MG-Z02	0.68	7.00	10.0	16.0	19.0
TMPC0402HP-1R0MG-Z02	1.00	5.00	8.50	22.0	27.0
TMPC0402HP-2R2MG-Z02	2.20	4.00	6.00	51.0	61.0
TMPC0402HP-3R3MG-Z02	3.30	3.50	4.00	69.0	76.0
TMPC0402HP-4R7MG-Z02	4.70	2.60	3.50	95.0	105
TMPC0402HP-6R8MG-Z02	6.80	2.10	2.80	150	172
TMPC0402HP-100MG-Z02	10.0	1.80	2.30	215	243
TMPC0402HP-220MG-Z02	22.0	1.20	1.40	470	500

Note:

1. Test frequency : L : 100KHz /1.0V.
2. All test data referenced to 25°C ambient.
3. Heat Rated Current (I_{rms}) will cause the coil temperature rise approximately Δt of 40°C.
4. Saturation Current (I_{sat}) will cause L₀ to drop 30% typical.
5. Special inquiries besides the above common used types can be met on your requirement.

■ DC Bias Characteristics (Typical)

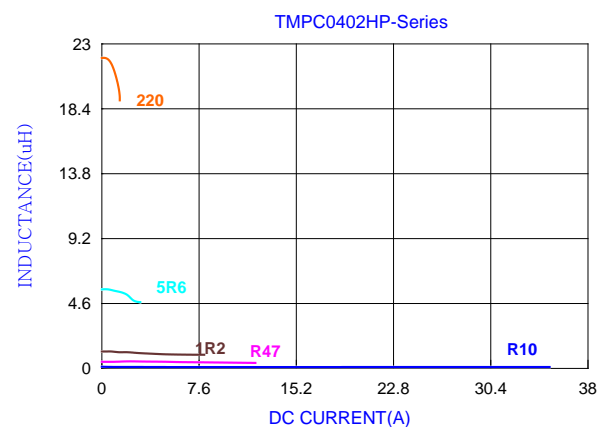
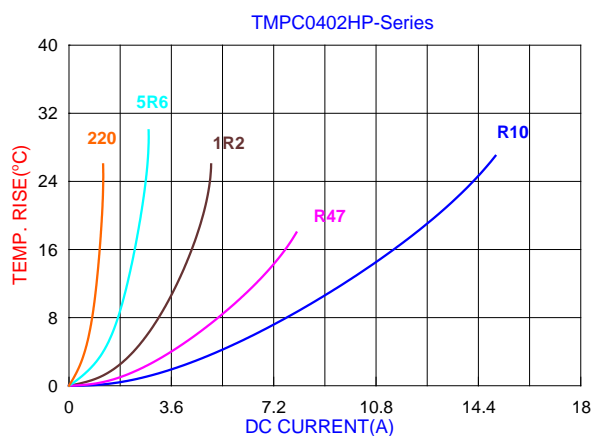

Molding Type High Current Power Inductors

TMPC 0512HP Series (2020 inch)



■ Dimensions

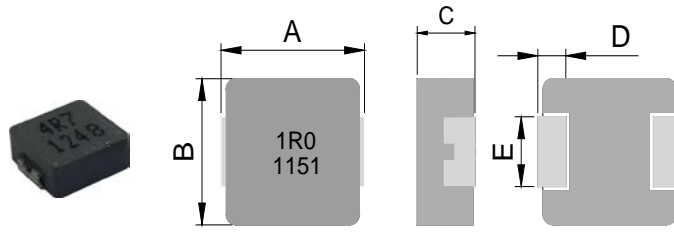

Chip Size	
A	5.70±0.30
B	5.20±0.20
C	1.00±0.20
D	1.10±0.30
E	2.50±0.30

Units: mm

■ Specifications

Part Number	Inductance L0 (uH)±20%	I rms (A)typ	I sat (A)typ	DCR (mΩ) typ. @25°C.	DCR (mΩ) max. @25°C.
TMPC0512HP-R10YG-D	0.10±30%	14.0	14.5	4.30	5.20
TMPC0512HP-R47MG-D	0.47	7.00	11.00	13.6	15.8
TMPC0512HP-R68MG-D	0.68	6.00	9.00	21.5	24.5
TMPC0512HP-1R0MG-D	1.00	5.00	6.00	26.0	30.0
TMPC0512HP-2R2MG-D	2.20	3.50	4.00	65.0	75.0
TMPC0512HP-3R3MG-D	3.30	3.00	3.80	75.0	86.0
TMPC0512HP-4R7MG-D	4.70	2.50	3.20	100	115
TMPC0512HP-5R6MG-D	5.60	2.40	3.20	175	201
TMPC0512HP-6R8MG-D	6.80	2.00	3.00	193	222
TMPC0512HP-100MG-D	10.0	1.50	1.80	335	385

Note:

1. Test frequency : L : 100KHz /1.0V.
2. All test data referenced to 25°C ambient.
3. Heat Rated Current (I_{rms}) will cause the coil temperature rise approximately Δt of 40°C.
4. Saturation Current (I_{sat}) will cause L₀ to drop 30% typical.
5. Special inquiries besides the above common used types can be met on your requirement.

■ DC Bias Characteristics (Typical)

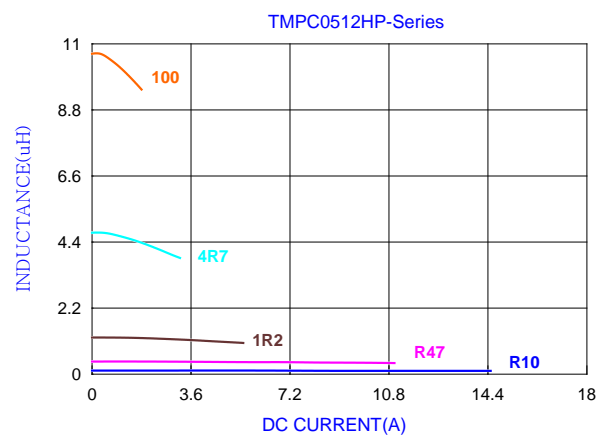
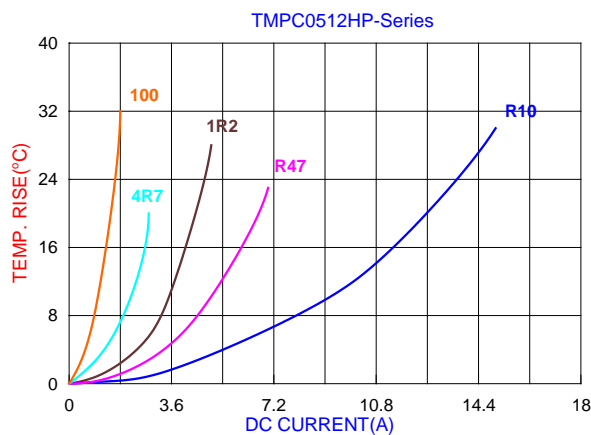

Molding Type High Current Power Inductors

TMPC 0515HP Series (2020 inch)

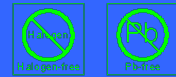

■ Dimensions

Chip Size	
A	5.70±0.30
B	5.20±0.20
C	1.30±0.20
D	1.10±0.30
E	2.50±0.30

Units: mm

■ Specifications

Part Number	Inductance L0 (uH)±20%	I rms (A)typ	I sat (A)typ	DCR (mΩ) typ. @25°C.	DCR (mΩ) max. @25°C.
TMPC0515HP-R20YG-D	0.20±30%	15.0	22.5	3.80	4.20
TMPC0515HP-R47MG-D	0.47	8.00	15.0	12.0	13.8
TMPC0515HP-R68MG-D	0.68	7.00	13.0	14.0	16.2
TMPC0515HP-1R0MG-D	1.00	6.00	9.00	22.0	25.3
TMPC0515HP-2R2MG-D	2.20	4.00	6.00	45.0	52.0
TMPC0515HP-3R3MG-D	3.30	3.20	4.50	78.0	90.0
TMPC0515HP-4R7MG-D	4.70	2.70	4.00	103	118
TMPC0515HP-5R6MG-D	5.60	2.40	3.20	126	152
TMPC0515HP-6R8MG-D	6.80	2.30	3.00	142	171
TMPC0515HP-100MG-D	10.0	2.00	2.30	210	235
TMPC0515HP-220MG-D	22.0	1.20	1.70	405	466

- Note:
1. Test frequency : L : 100KHz /1.0V.
 2. All test data referenced to 25°C ambient.
 3. Heat Rated Current (I_{rms}) will cause the coil temperature rise approximately Δt of 40°C.
 4. Saturation Current (I_{sat}) will cause L0 to drop 30% typical.
 5. Special inquiries besides the above common used types can be met on your requirement.

■ DC Bias Characteristics (Typical)

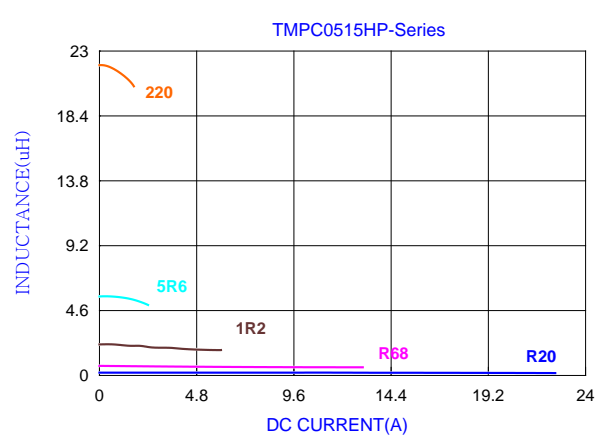
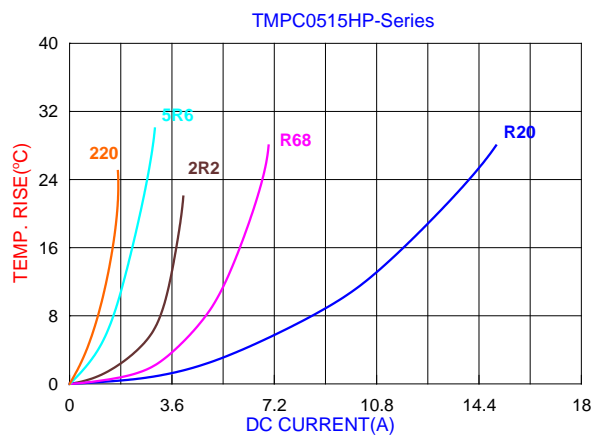

Molding Type High Current Power Inductors

TMPC 0518HP Series (2020 inch)

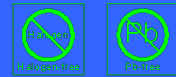

■ Dimensions

Chip Size	
A	5.70±0.30
B	5.20±0.20
C	1.60±0.20
D	1.10±0.30
E	2.50±0.30

Units: mm

■ Specifications

Part Number	Inductance L0 (uH)±20%	I rms (A)typ	I sat (A)typ	DCR (mΩ) Typ. @25°C.	DCR (mΩ) max. @25°C.
TMPC0518HP-R33MG-D	0.33	11.0	15.0	7.50	8.60
TMPC0518HP-R47MG-D	0.47	10.0	14.0	9.80	11.3
TMPC0518HP-R68MG-D	0.68	9.00	13.0	12.4	14.3
TMPC0518HP-1R0MG-D	1.0	6.80	10.0	18.2	21.0
TMPC0518HP-2R2MG-D	2.2	4.50	7.50	42.0	48.3
TMPC0518HP-3R3MG-D	3.3	3.50	5.00	60.0	69.0
TMPC0518HP-4R7MG-D	4.7	3.00	4.50	85.0	98.0
TMPC0518HP-5R6MG-D	5.6	2.50	4.00	110	127
TMPC0518HP-6R8MG-D	6.8	2.40	3.50	118	137
TMPC0518HP-100MG-D	10.0	2.30	2.80	165	190
TMPC0518HP-150MG-D	15.0	1.70	2.30	275	318

Note:

1. Test frequency : L : 100KHz /1.0V.
2. All test data referenced to 25°C ambient.
3. Heat Rated Current (I_{rms}) will cause the coil temperature rise approximately Δt of 40°C .
4. Saturation Current (I_{sat}) will cause L0 to drop 30% typical.
5. Special inquiries besides the above common used types can be met on your requirement.

■ DC Bias Characteristics (Typical)

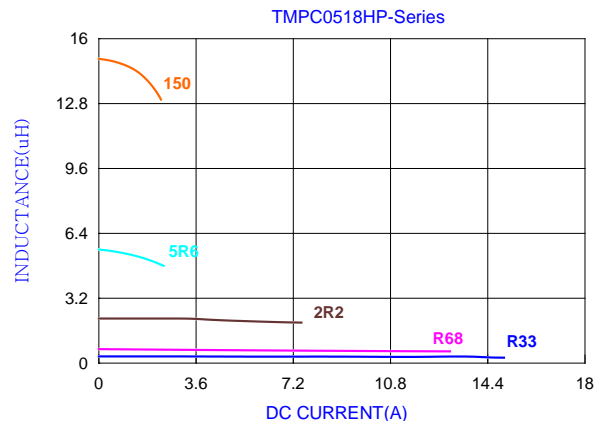
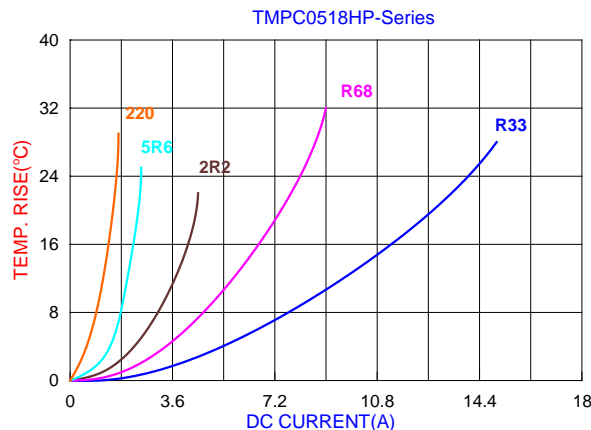

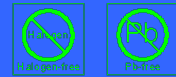

■ Dimensions

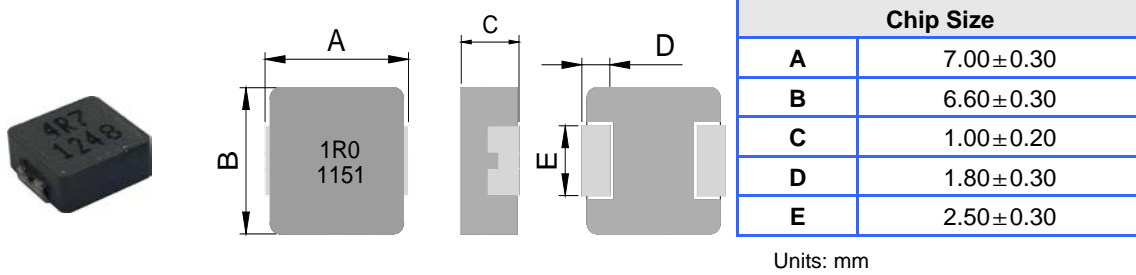

■ Specifications

Part Number	Inductance L0 (uH)±20%	I rms (A)typ	I sat (A)typ	DCR (mΩ) typ. @25°C.	DCR (mΩ) max. @25°C.
TMPC0612H-R22YG-D	0.22±30%	11.0	19.0	6.50	7.50
TMPC0612H-R47MG-D	0.47	8.50	12.0	13.0	17.0
TMPC0612H-R68MG-D	0.68	7.00	9.00	17.0	19.0
TMPC0612H-1R0MG-D	1.00	6.00	7.00	27.0	30.0
TMPC0612H-2R2MG-D	2.20	4.00	5.00	53.0	61.0
TMPC0612H-3R3MG-D	3.30	3.20	4.00	90.0	103
TMPC0612H-4R7MG-D	4.70	2.50	3.80	130	150
TMPC0612H-6R8MG-D	6.80	2.10	3.00	172	198
TMPC0612H-100MG-D	10.0	1.80	2.50	280	290

Note:

1. Test frequency : L : 100KHz /1.0V.
2. All test data referenced to 25°C ambient.
3. Heat Rated Current (I_{rms}) will cause the coil temperature rise approximately Δt of 40°C.
4. Saturation Current (I_{sat}) will cause L0 to drop 30% typical.
5. Special inquiries besides the above common used types can be met on your requirement.

■ DC Bias Characteristics (Typical)

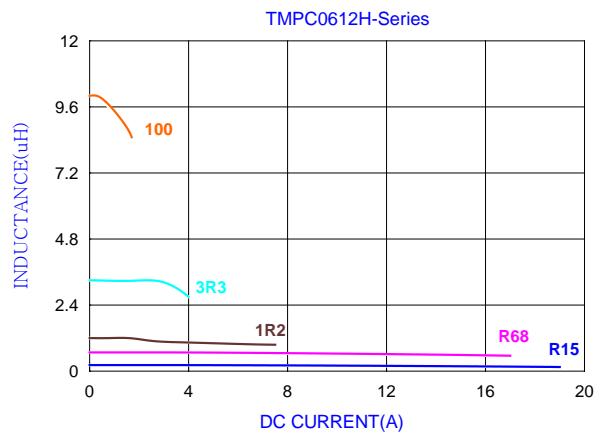
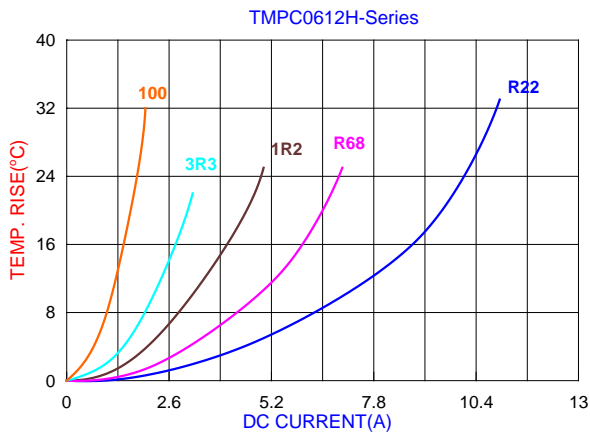



■ Dimensions

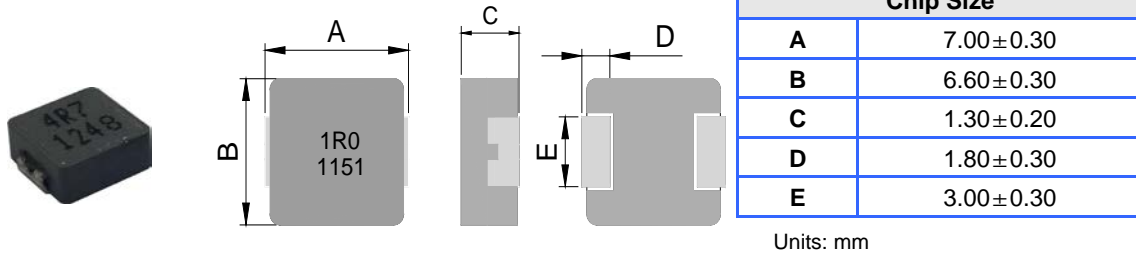

■ Specification

Part Number	Inductance L0 (uH)±20%	I rms (A)typ	I sat (A)typ	DCR (mΩ) typ. @25°C.	DCR (mΩ) max. @25°C.
TMPC0615H-R22YG-D	0.22±30%	14.0	22.0	4.30	5.20
TMPC0615H-R47MG-D	0.47	9.50	16.0	9.00	10.3
TMPC0615H-R68MG-D	0.68	7.50	15.0	13.8	15.2
TMPC0615H-1R0MG-D	1.00	6.50	12.0	23.0	25.8
TMPC0615H-2R2MG-D	2.20	4.50	6.50	48.0	55.0
TMPC0615H-3R3MG-D	3.30	4.20	6.00	62.0	74.0
TMPC0615H-4R7MG-D	4.70	3.80	5.00	96.0	111
TMPC0615H-5R6MG-D	5.60	3.00	4.50	115	138
TMPC0615H-6R8MG-D	6.80	2.60	3.50	128	148
TMPC0615H-100MG-D	10.0	2.30	2.80	180	216
TMPC0615H-220MG-D	22.0	1.50	2.50	420	504

Note:

1. Test frequency : L : 100KHz /1.0V.
2. All test data referenced to 25°C ambient.
3. Heat Rated Current (I_{rms}) will cause the coil temperature rise approximately Δt of 40°C.
4. Saturation Current (I_{sat}) will cause L0 to drop 30% typical.
5. Special inquiries besides the above common used types can be met on your requirement.

■ DC Bias Characteristics (Typical)

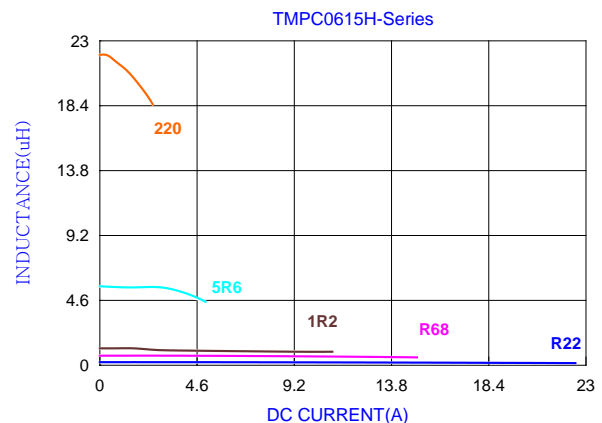
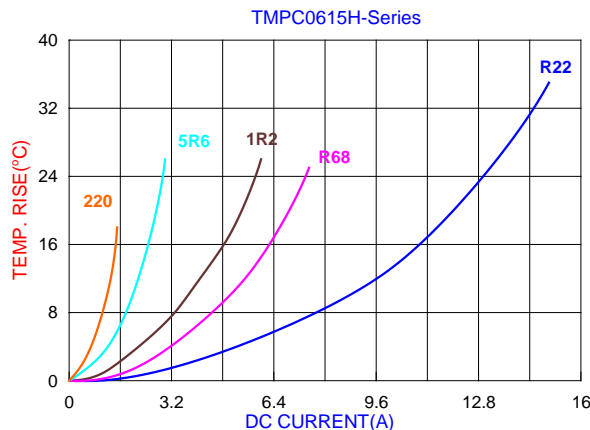



■ Dimensions

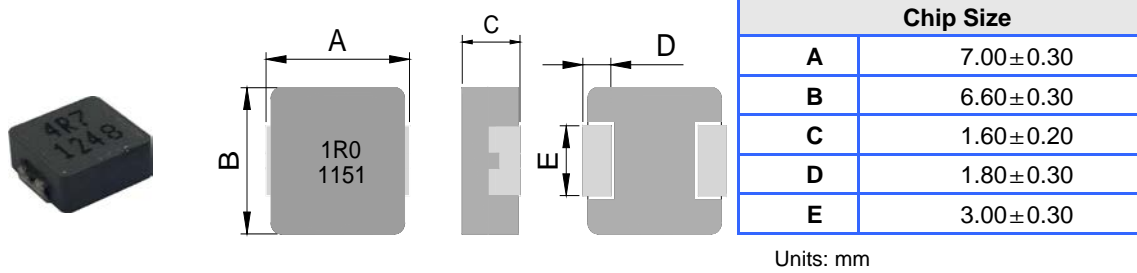

■ Specification

Part Number	Inductance L0 (uH)±20%	I rms (A)typ	I sat (A)typ	DCR (mΩ) typ. @25°C.	DCR (mΩ) max. @25°C.
TMPC0618H-R22MG-D	0.22	16.0	26.0	2.50	3.00
TMPC0618H-R47MG-D	0.47	12.0	18.0	6.40	7.40
TMPC0618H-R68MG-D	0.68	10.0	17.0	9.50	11.0
TMPC0618H-1R0MG-D	1.00	7.00	14.0	14.5	17.0
TMPC0618H-2R2MG-D	2.20	6.00	11.0	31.0	35.0
TMPC0618H-3R3MG-D	3.30	5.00	9.00	40.0	46.0
TMPC0618H-4R7MG-D	4.70	4.00	7.00	68.0	76.0
TMPC0618H-5R6MG-D	5.60	3.50	6.00	78.0	86.0
TMPC0618H-6R8MG-D	6.80	3.00	5.50	93.0	104
TMPC0618H-100MG-D	10.0	2.30	3.50	143	160

Note:

1. Test frequency : L : 100KHz /1.0V.
2. All test data referenced to 25°C ambient.
3. Heat Rated Current (I_{rms}) will cause the coil temperature rise approximately Δt of 40°C
4. Saturation Current (I_{sat}) will cause L₀ to drop 30% typical.
5. Special inquiries besides the above common used types can be met on your requirement.

■ DC Bias Characteristics (Typical)

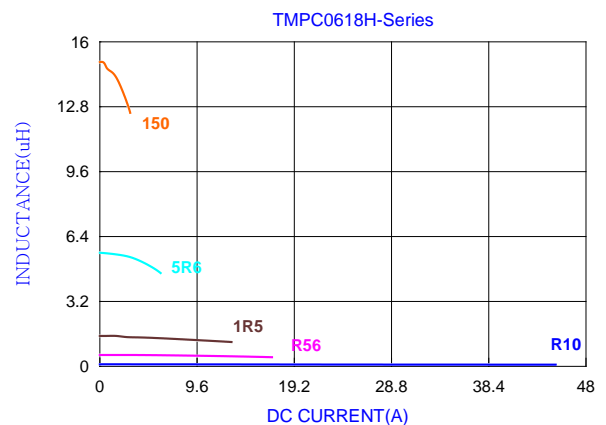
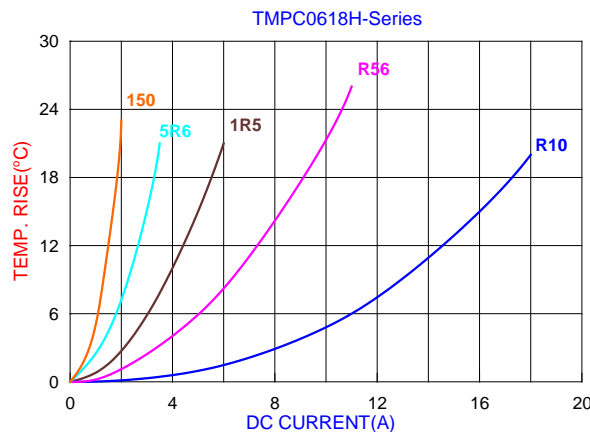

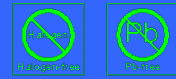

■ Dimensions

Chip Size	
A	7.00±0.30
B	6.60±0.30
C	1.80±0.20
D	1.80±0.30
E	3.00±0.30

Units: mm

■ Specification

Part Number	Inductance L0 (uH)±20%	I rms (A)typ	I sat (A)typ	DCR (mΩ) typ. @25°C.	DCR (mΩ) max. @25°C.
TMPC0602H-R10YG-D	0.10±30%	21.0	40.0	2.00	2.40
TMPC0602H-R47MG-D	0.47±20%	11.7	20.0	7.10	8.30
TMPC0602H-R68MG-D	0.68±20%	10.5	16.0	8.30	10.0
TMPC0602H-1R0MG-D	1.00±20%	8.00	14.0	16.5	18.0
TMPC0602H-2R2MG-D	2.20±20%	6.00	10.0	32.0	37.0
TMPC0602H-3R3MG-D	3.30±20%	5.00	8.00	43.0	48.0
TMPC0602H-4R7MG-D	4.70±20%	4.50	7.00	53.0	60.0
TMPC0602H-5R6MG-D	5.60±20%	4.00	6.00	59.0	68.0
TMPC0602H-6R8MG-D	6.80±20%	4.00	5.50	63.0	73.0
TMPC0602H-100MG-D	10.0±20%	2.80	4.00	134	154
TMPC0602H-220MG-D	22.0±20%	1.50	2.50	236	280

Note:

1. Test frequency : L : 100KHz /1.0V.
2. All test data referenced to 25°C ambient.
3. Heat Rated Current (I_{rms}) will cause the coil temperature rise approximately Δt of 40°C.
4. Saturation Current (I_{sat}) will cause L0 to drop 30% typical.
5. Special inquiries besides the above common used types can be met on your requirement.

■ DC Bias Characteristics (Typical)

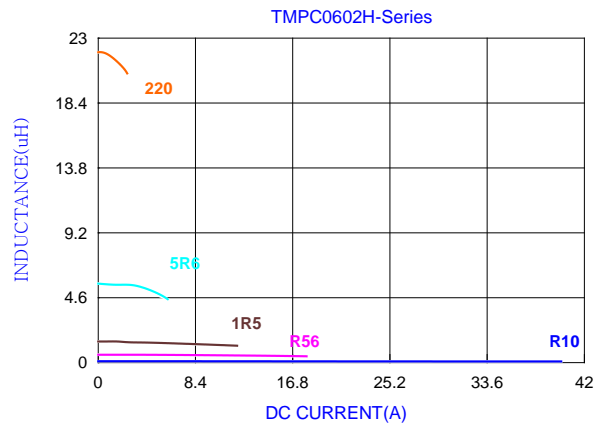
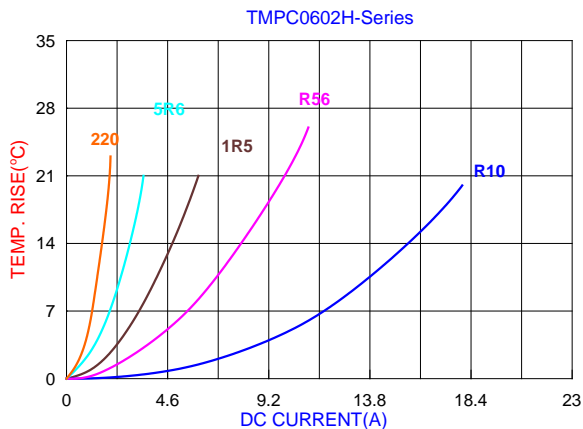

Molding Type High Current Power Inductors

TMPC 0624H Series

(2525 inch)



■ Dimensions

Chip Size	
A	7.00±0.30
B	6.60±0.30
C	2.20±0.20
D	1.80±0.30
E	3.00±0.30

Units: mm

■ Specification

Part Number	Inductance L0 (uH)	I rms (A)typ	I sat (A)typ	DCR (mΩ) typ. @25°C.	DCR (mΩ) max. @25°C.
TMPC0624H-R22MG-D	0.22±20%	21.0	34.0	2.00	3.20
TMPC0624H-R47MG-D	0.47±20%	15.0	26.0	4.80	5.10
TMPC0624H-R68MG-D	0.68±20%	13.0	21.0	6.40	7.20
TMPC0624H-1R0MG-D	1.00±20%	11.0	16.0	10.5	13.5
TMPC0624H-2R2MG-D	2.20±20%	7.0	14.0	23.0	28.0
TMPC0624H-3R3MG-D	3.30±20%	6.0	10.0	34.0	39.0
TMPC0624H-4R7MG-D	4.70±20%	5.5	9.0	41.0	50.0
TMPC0624H-5R6MG-D	5.60±20%	5.0	8.0	56.0	62.0
TMPC0624H-6R8MG-D	6.80±20%	4.0	7.0	65.0	72.0
TMPC0624H-100MG-D	10.0±20%	3.2	5.0	92.0	101

Note:

1. Test frequency : L : 100KHz /1.0V.
2. All test data referenced to 25°C ambient.
3. Heat Rated Current (I_{rms}) will cause the coil temperature rise approximately Δt of 40°C .
4. Saturation Current (I_{sat}) will cause L₀ to drop 30% typical.
5. Special inquiries besides the above common used types can be met on your requirement.

■ DC Bias Characteristics (Typical)

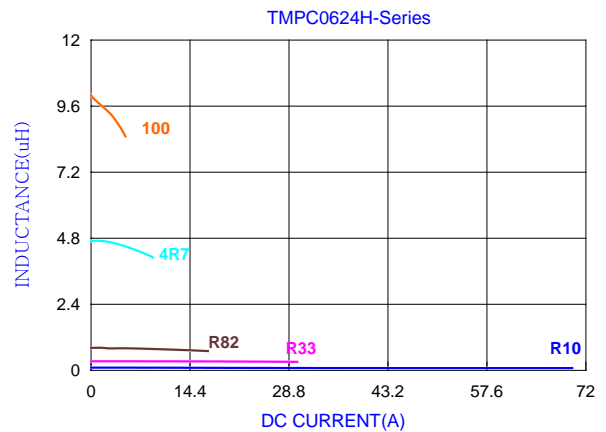
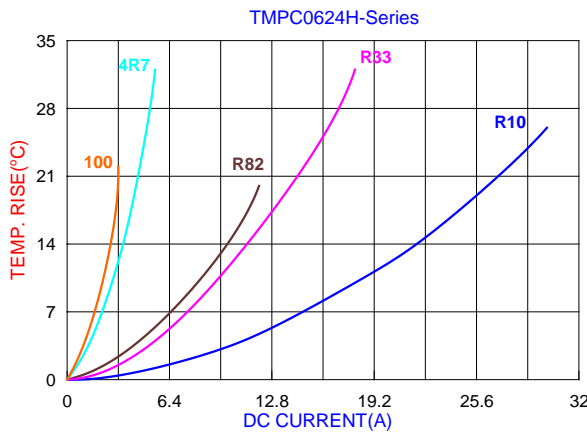

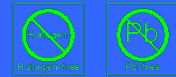

■ Dimensions

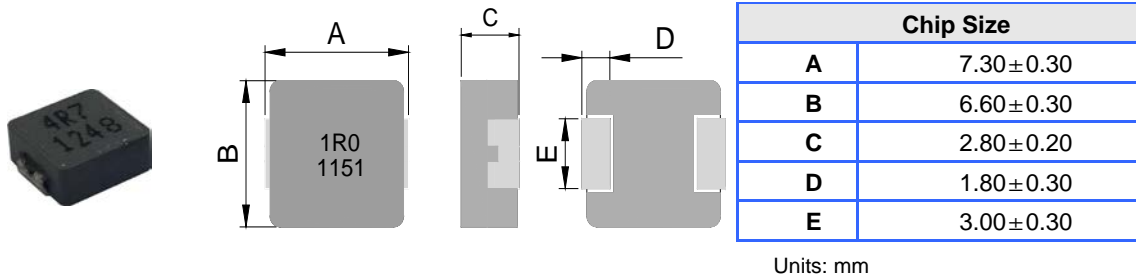

■ Specification

Part Number	Inductance L0 (uH)±20%	I rms (A)typ	I sat (A)typ	DCR (mΩ) typ. @25°C.	DCR (mΩ) max. @25°C.
TMPC0603H-R10YG-D	0.10±30%	32.5	60.0	1.2	1.7
TMPC0603H-R22YG-D	0.22±30%	23.0	40.0	2.1	2.8
TMPC0603H-R47MG-D	0.47	17.5	26.0	4.0	4.2
TMPC0603H-R68MG-D	0.68	15.5	25.0	4.8	5.5
TMPC0603H-1R0MG-D	1.00	11.0	22.0	8.3	10.0
TMPC0603H-2R2MG-D	2.20	8.0	14.0	18.0	20.0
TMPC0603H-3R3MG-D	3.30	6.0	13.5	28.0	30.0
TMPC0603H-4R7MG-D	4.70	5.5	10.0	37.0	40.0
TMPC0603H-5R6MG-D	5.60	5.0	9.0	43.0	48.0
TMPC0603H-6R8MG-D	6.80	4.5	8.0	54.0	60.0
TMPC0603H-100MG-D	10.0	3.5	6.0	75.0	85.0

Note:

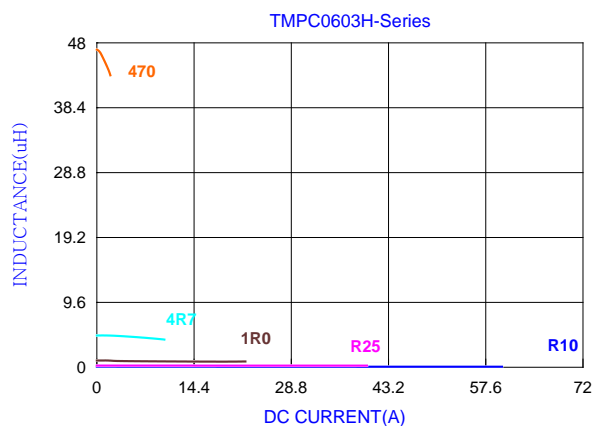
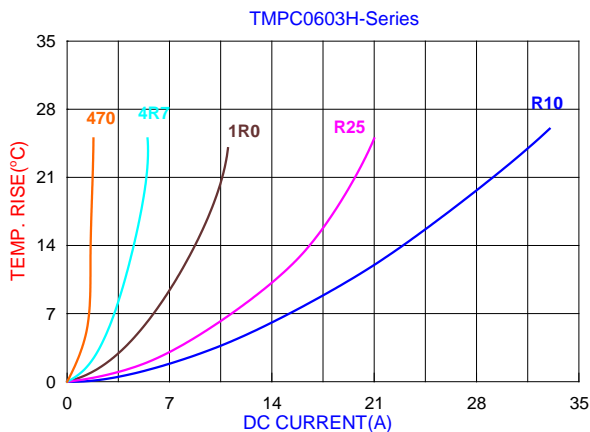

1. Test frequency : L : 100KHz /1.0V.
2. All test data referenced to 25°C ambient.
3. Heat Rated Current (I_{rms}) will cause the coil temperature rise approximately Δt of 40°C
4. Saturation Current (I_{sat}) will cause L0 to drop 30% typical.
5. Special inquiries besides the above common used types can be met on your requirement.

■ DC Bias Characteristics (Typical)

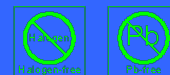

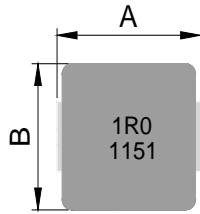

■ Dimensions

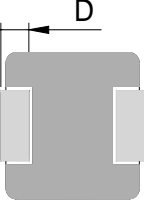
Chip Size	
A	7.30±0.30
B	6.60±0.30
C	3.80±0.20
D	1.80±0.30
E	3.00±0.30

Units: mm

■ Specification

Part Number	Inductance L0 (uH)±20%	I rms (A)typ	I sat (A)typ	DCR (mΩ) typ. @25°C.	DCR (mΩ) max. @25°C.
TMPC0604H-R15YG-D	0.15	30.0	55.0	0.9	1.2
TMPC0604H-R47MG-D	0.47	23.0	28.0	3.0	3.4
TMPC0604H-R68MG-D	0.68	16.0	24.0	4.1	4.5
TMPC0604H-1R0MG-D	1.00	14.0	22.0	6.8	8.0
TMPC0604H-2R2MG-D	2.20	9.0	14.0	11.5	14.0
TMPC0604H-3R3MG-D	3.30	8.0	12.0	24.0	27.0
TMPC0604H-4R7MG-D	4.70	6.0	11.0	28.0	32.5
TMPC0604H-5R6MG-D	5.60	5.0	9.0	33.0	38.0
TMPC0604H-6R8MG-D	6.80	4.5	8.5	44.0	50.0
TMPC0604H-100MG-D	10.0	4.0	7.0	64.0	72.0
TMPC0604H-150MG-D	15.0	3.0	3.5	80.0	90.0

Note:

1. Test frequency : L : 100KHz /1.0V.
2. All test data referenced to 25°C ambient.
3. Heat Rated Current (I_{rms}) will cause the coil temperature rise approximately Δt of 40°C
4. Saturation Current (I_{sat}) will cause L0 to drop 30% typical.
5. Special inquiries besides the above common used types can be met on your requirement.

■ DC Bias Characteristics (Typical)

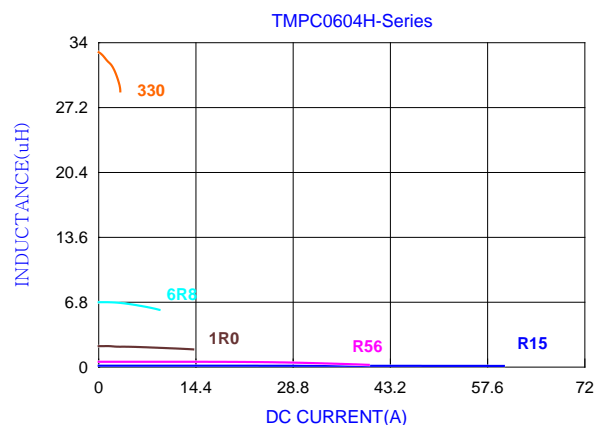
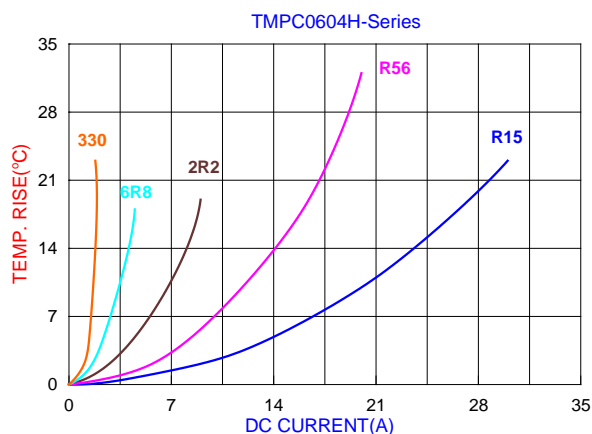

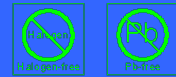

■ Dimensions

Chip Size	
A	7.30±0.30
B	6.60±0.30
C	4.80±0.20
D	1.80±0.30
E	3.00±0.30

Units: mm

■ Specification

Part Number	Inductance L0 (uH)±20%	I rms (A)typ	I sat (A)typ	DCR (mΩ) typ. @25°C.	DCR (mΩ) max. @25°C.
TMPC0605H-R33MG-D	0.33	25.0	32.0	2.5	3.0
TMPC0605H-R47MG-D	0.47	22.0	30.0	3.5	3.9
TMPC0605H-R68MG-D	0.68	18.0	24.0	4.0	4.5
TMPC0605H-1R0MG-D	1.00	15.0	20.0	6.1	6.5
TMPC0605H-2R2MG-D	2.20	10.0	14.0	11.2	12.0
TMPC0605H-3R3MG-D	3.30	8.0	12.0	19.0	20.9
TMPC0605H-4R7MG-D	4.70	6.5	10.0	28.0	30.8
TMPC0605H-5R6MG-D	5.60	6.0	9.0	43.5	49.0
TMPC0605H-6R8MG-D	6.80	5.5	8.5	46.0	51.5
TMPC0605H-100MG-D	10.0	4.0	7.5	60.0	69.0
TMPC0605H-220MG-D	22.0	2.5	5.5	140	170

Note:

1. Test frequency : L : 100KHz /1.0V.
2. All test data referenced to 25°C ambient.
3. Heat Rated Current (I_{rms}) will cause the coil temperature rise approximately Δt of 40°C
4. Saturation Current (I_{sat}) will cause L0 to drop 30% typical.
5. Special inquiries besides the above common used types can be met on your requirement.

■ DC Bias Characteristics (Typical)

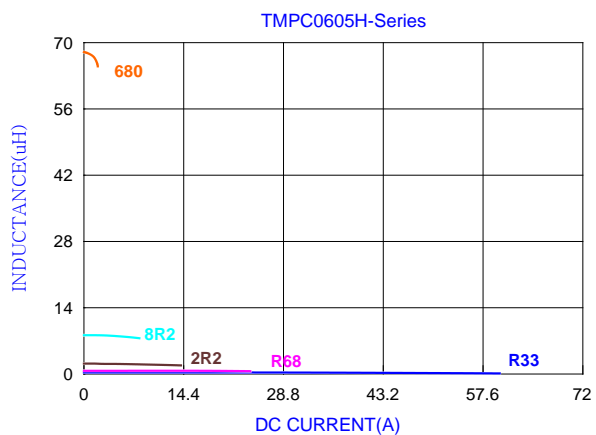
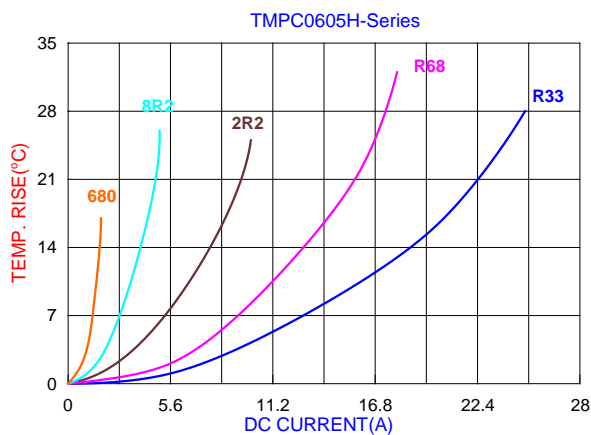

Molding Type High Current Power Inductors

TMPC 1004H Series (4040 inch)

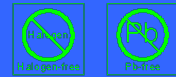

■ Dimensions

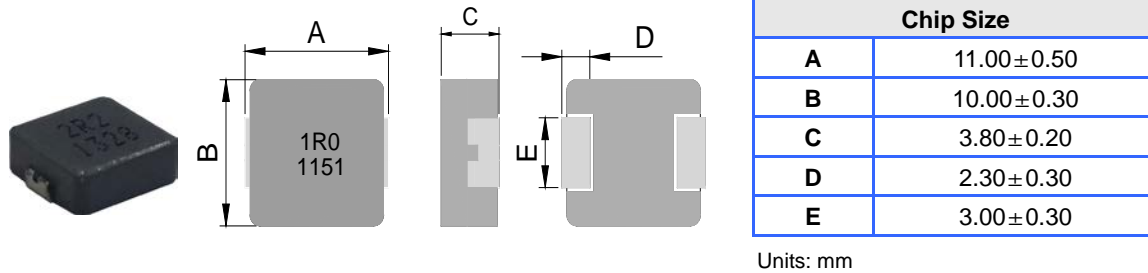

■ Specifications

Part Number	Inductance L0 (uH) ±20%	I rms (A)typ	I sat (A)typ	DCR (mΩ) typ. @25°C.	DCR (mΩ) max. @25°C.
TMPC1004H-R15YG-D	0.15±30%	43.0	75.0	0.5	0.6
TMPC1004H-R47MG-D	0.47	28.0	43.0	1.3	1.5
TMPC1004H-R68MG-D	0.68	22.0	39.0	2.4	2.7
TMPC1004H-1R0MG-D	1.00	18.0	36.0	3.0	3.3
TMPC1004H-2R2MG-D	2.20	12.0	27.0	6.5	7.0
TMPC1004H-3R3MG-D	3.30	11.0	20.0	10.8	11.8
TMPC1004H-4R7MG-D	4.70	10.0	17.0	15.0	15.5
TMPC1004H-5R6MG-D	5.60	9.0	14.0	17.0	19.3
TMPC1004H-6R8MG-D	6.80	8.5	13.5	17.5	23.3
TMPC1004H-8R2MG-D	8.20	8.0	12.5	20.0	22.5
TMPC1004H-100MG-D	10.0	7.5	12.0	27.0	30.0
TMPC1004H-220MG-D	22.0	5.0	7.0	64.0	74.0

Note:

1. Test frequency : L : 100KHz /1.0V.
2. All test data referenced to 25°C ambient.
3. Heat Rated Current (I_{rms}) will cause the coil temperature rise approximately Δt of 40°C
4. Saturation Current (I_{sat}) will cause L₀ to drop 30% typical.
5. Special inquiries besides the above common used types can be met on your requirement.

■ DC Bias Characteristics (Typical)

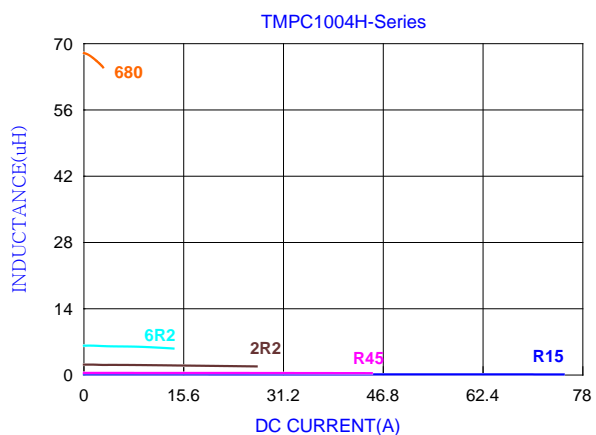
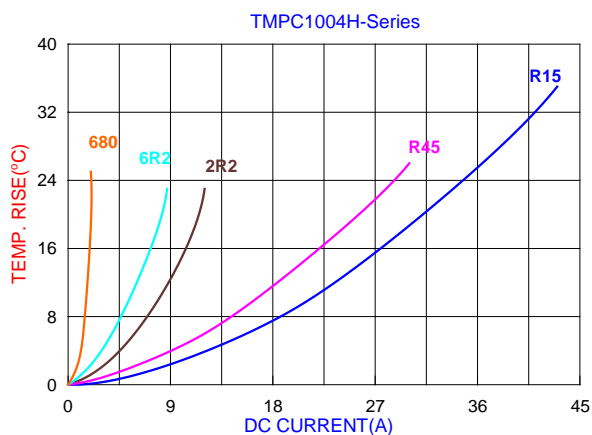

Molding Type High Current Power Inductors

TMPC 1005H Series (4040 inch)

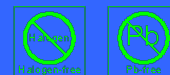

■ Dimensions

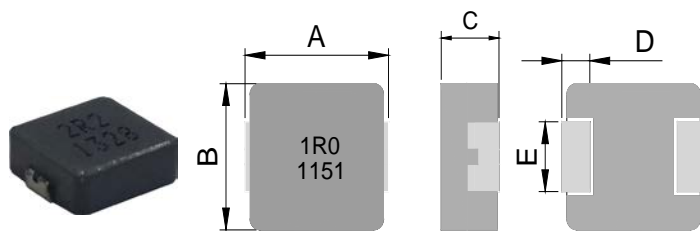

Chip Size	
A	11.00±0.50
B	10.00±0.30
C	4.80±0.20
D	2.30±0.30
E	3.00±0.30

Units: mm

■ Specifications

Part Number	Inductance L0 (uH) ±20%	I rms (A)typ	I sat (A)typ	DCR (mΩ) typ. @25°C.	DCR (mΩ) max. @25°C.
TMPC1005H-R30MG-D	0.30	38.0	65.0	0.57	0.61
TMPC1005H-R90MG-D	0.90	25.0	32.0	2.2	3.0
TMPC1005H-1R0MG-D	1.00	22.0	30.0	2.8	3.5
TMPC1005H-2R2MG-D	2.20	16.0	24.0	5.4	6.0
TMPC1005H-3R3MG-D	3.30	14.0	22.0	9.0	10.4
TMPC1005H-5R6MG-D	5.60	10.0	16.0	14.0	16.8
TMPC1005H-100MG-D	10.0	8.0	13.5	25.0	29.0
TMPC1005H-330MG-D	33.0	4.3	7.5	80.0	92.0
TMPC1005H-470MG-D	47.0	3.8	6.5	125	145
TMPC1005H-680MG-D	68.0	2.5	4.0	176	205

Note:

1. Test frequency : L : 100KHz / 1.0V.
2. All test data referenced to 25°C ambient.
3. Heat Rated Current (I_{rms}) will cause the coil temperature rise approximately Δt of 40°C
4. Saturation Current (I_{sat}) will cause L0 to drop 30% typical.
5. Special inquiries besides the above common used types can be met on your requirement.

■ DC Bias Characteristics (Typical)

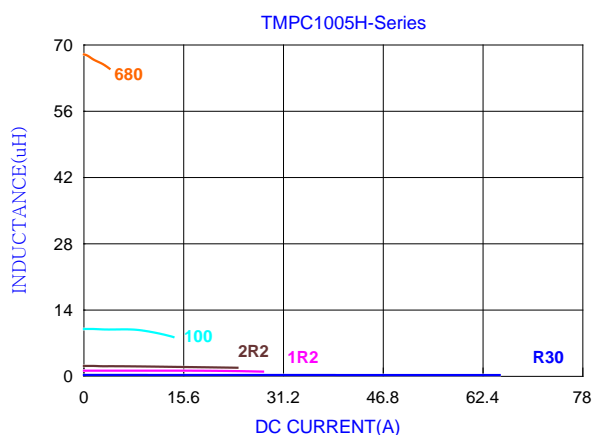
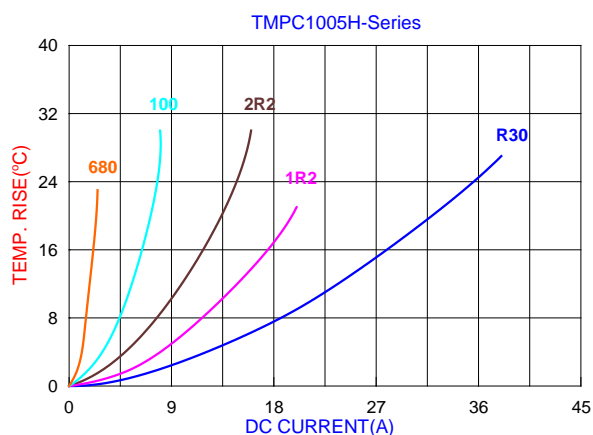

Molding Type High Current Power Inductors

TMPC 1235HP Series (5050 inch)

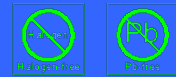

■ Dimensions

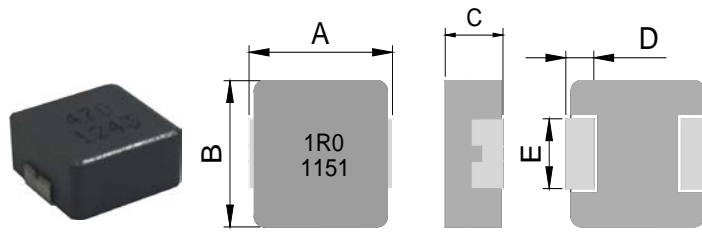

Chip Size	
A	13.5 ±0.5
B	12.5 ±0.3
C	3.3 ±0.2
D	2.3 ±0.3
E	4.7 ±0.3

Units: mm

■ Specifications

Part Number	Inductance L0 (uH) ±20%	I rms (A)typ	I sat (A)typ	DCR (mΩ) typ. @25°C.	DCR (mΩ) max. @25°C.
TMPC1235HP-R10YG-D	0.10±30%	43.0	84.0	0.36	0.43
TMPC1235HP-R47MG-D	0.47	32.0	55.0	1.20	1.80
TMPC1235HP-R68MG-D	0.68	28.0	49.0	1.90	2.50
TMPC1235HP-1R0MG-D	1.00	24.0	40.0	2.70	3.50
TMPC1235HP-2R2MG-D	2.20	16.0	29.0	6.30	8.00
TMPC1235HP-3R3MG-D	3.30	12.0	27.0	11.00	13.50
TMPC1235HP-4R7MG-D	4.70	10.0	24.0	15.30	18.50
TMPC1235HP-5R6MG-D	5.60	9.5	19.0	18.00	22.00
TMPC1235HP-6R8MG-D	6.80	9.0	18.0	20.00	24.00
TMPC1235HP-8R2MG-D	8.20	8.5	16.0	23.00	28.00
TMPC1235HP-100MG-D	10.0	7.0	14.0	29.00	34.00

Note:

1. Test frequency : L : 100KHz /1.0V.
2. All test data referenced to 25°C ambient.
3. Heat Rated Current (I_{rms}) will cause the coil temperature rise approximately Δt of 40°C
4. Saturation Current (I_{sat}) will cause L0 to drop 30% typical.
5. Special inquiries besides the above common used types can be met on your requirement.

■ DC Bias Characteristics (Typical)

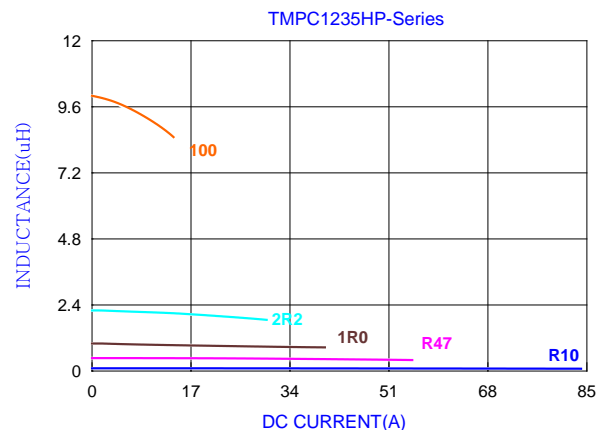
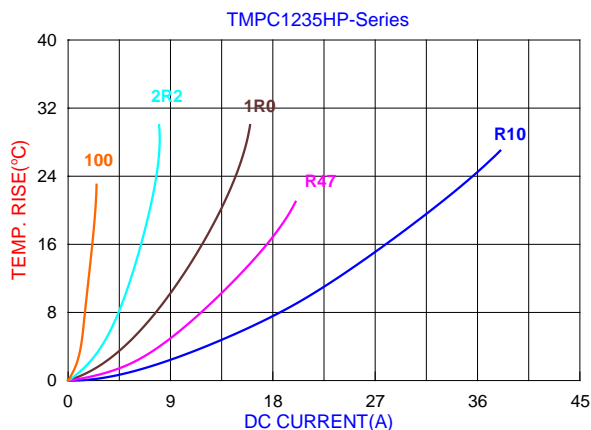

Molding Type High Current Power Inductors

TMPC 1205HP Series (5050 inch)

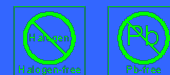

■ Dimensions

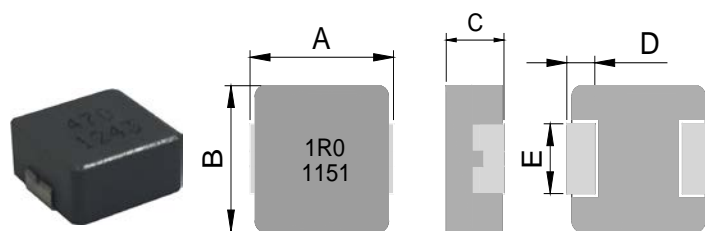

Chip Size	
A	13.50±0.50
B	12.50±0.30
C	4.80±0.20
D	2.30±0.30
E	4.70±0.30

Units: mm

■ Specifications

Part Number	Inductance L0 (uH) ±20%	I rms (A)typ	I sat (A)typ	DCR (mΩ) typ. @25°C.	DCR (mΩ) max. @25°C.
TMPC1205HP-R20MG-D	0.20	52.0	110.0	0.45	0.55
TMPC1205HP-R47MG-D	0.47	38.0	65.0	0.86	1.10
TMPC1205HP-R68MG-D	0.68	34.0	54.0	1.40	1.70
TMPC1205HP-1R0MG-D	1.00	29.0	50.0	1.85	2.50
TMPC1205HP-2R2MG-D	2.20	20.0	32.0	4.20	5.50
TMPC1205HP-3R3MG-D	3.30	15.0	32.0	6.80	9.20
TMPC1205HP-4R7MG-D	4.70	12.0	27.0	11.40	15.00
TMPC1205HP-6R8MG-D	6.80	11.0	21.0	14.50	18.50
TMPC1205HP-8R2MG-D	8.20	9.5	18.0	16.80	22.50
TMPC1205HP-100MG-D	10.0	9.0	16.0	21.40	25.50
TMPC1205HP-220MG-D	22.0	6.5	10.0	50.00	58.00

Note:

1. Test frequency : L : 100KHz /1.0V.
2. All test data referenced to 25°C ambient.
3. Heat Rated Current (I_{rms}) will cause the coil temperature rise approximately Δt of 40°C
4. Saturation Current (I_{sat}) will cause L0 to drop 30% typical.
5. Special inquiries besides the above common used types can be met on your requirement.

■ DC Bias Characteristics (Typical)

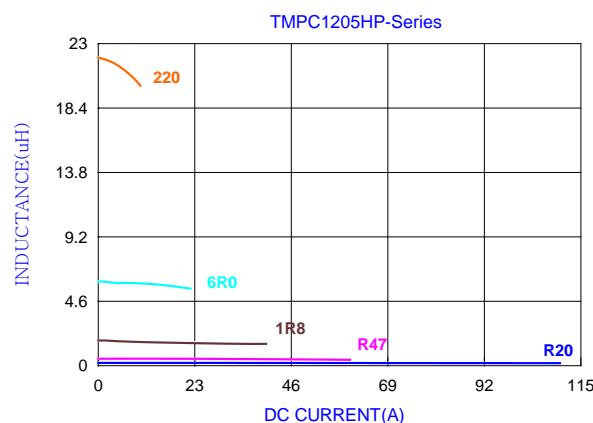
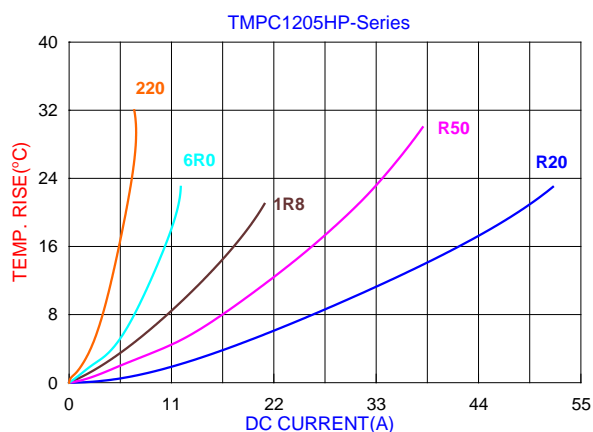

Molding Type High Current Power Inductors

TMPC 1206HP Series (5050 inch)

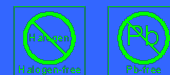

■ Dimensions

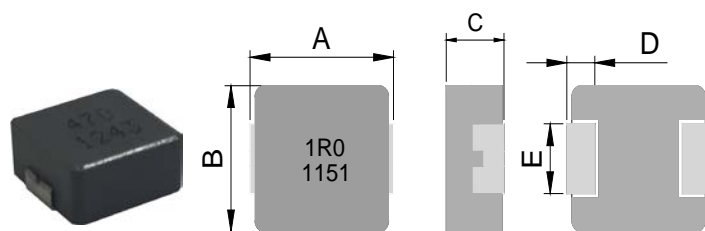

Chip Size	
A	13.50±0.50
B	12.50±0.30
C	5.70±0.30
D	2.30±0.30
E	4.70±0.30

Units: mm

■ Specifications

Part Number	Inductance L0 (uH)±20%	I rms (A)typ	I sat (A)typ	DCR (mΩ) typ. @25°C.	DCR (mΩ) max. @25°C.
TMPC1206HP-1R0MG-D	1.00	29.0	45.0	1.80	2.40
TMPC1206HP-2R2MG-D	2.20	21.0	34.0	4.00	4.70
TMPC1206HP-3R3MG-D	3.30	17.0	28.0	5.80	7.10
TMPC1206HP-4R7MG-D	4.70	16.0	25.0	9.50	11.50
TMPC1206HP-5R6MG-D	5.60	15.5	22.0	10.80	12.60
TMPC1206HP-6R8MG-D	6.80	15.0	19.0	12.00	13.80
TMPC1206HP-100MG-D	10.0	11.0	15.5	18.00	20.70
TMPC1206HP-220MG-D	22.0	8.0	11.0	34.00	39.50
TMPC1206HP-330MG-D	33.0	6.0	8.0	65.00	75.00
TMPC1206HP-470MG-D	47.0	5.5	7.0	80.00	90.00

Note:

1. Test frequency : L : 100KHz /1.0V.
2. All test data referenced to 25°C ambient.
3. Heat Rated Current (I_{rms}) will cause the coil temperature rise approximately Δt of 40°C
4. Saturation Current (I_{sat}) will cause L0 to drop 30% typical.
5. Special inquiries besides the above common used types can be met on your requirement.

■ DC Bias Characteristics (Typical)

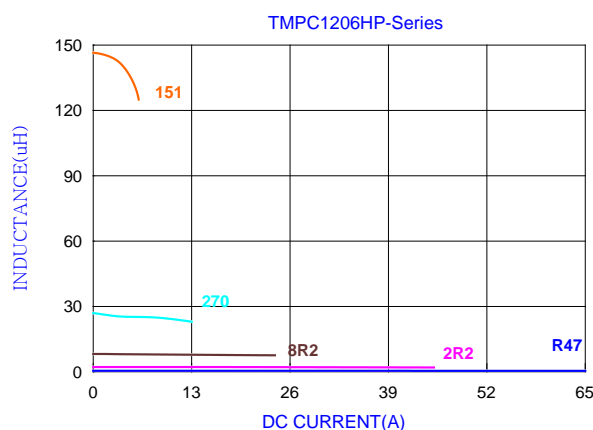
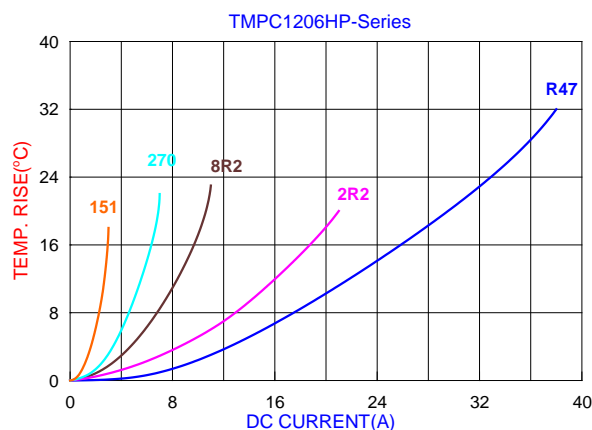

Molding Type High Current Power Inductors

TMPC 1265HP Series (5050 inch)

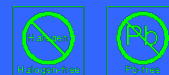

■ Dimensions

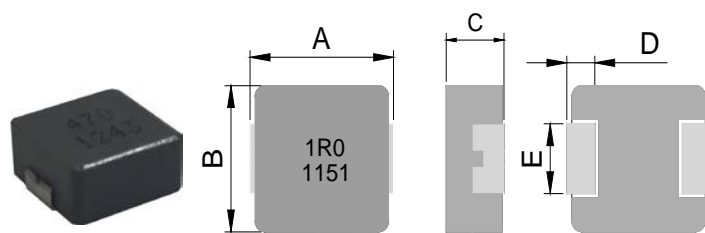

Chip Size	
A	13.50±0.50
B	12.50±0.30
C	6.20±0.30
D	2.30±0.30
E	4.70±0.30

Units: mm

■ Specifications

Part Number	Inductance L0 (uH)±20%	I rms (A)typ	I sat (A)typ	DCR (mΩ) typ. @25°C.	DCR (mΩ) max. @25°C.
TMPC1265HP-R15MG-D	0.15	55.0	118.0	0.49	0.60
TMPC1265HP-R47MG-D	0.47	41.0	63.0	0.90	1.20
TMPC1265HP-1R0MG-D	1.00	30.0	48.0	1.70	2.30
TMPC1265HP-2R2MG-D	2.20	22.0	37.0	3.80	4.20
TMPC1265HP-3R3MG-D	3.30	18.0	30.0	5.70	6.80
TMPC1265HP-4R7MG-D	4.70	13.5	28.0	7.00	8.40
TMPC1265HP-5R6MG-D	5.60	12.5	23.0	8.50	10.00
TMPC1265HP-6R8MG-D	6.80	11.5	18.0	9.50	11.50
TMPC1265HP-100MG-D	10.0	10.0	15.5	13.20	16.50
TMPC1265HP-220MG-D	22.0	9.0	12.0	32.50	37.00
TMPC1265HP-330MG-D	33.0	8.0	11.0	48.00	58.00
TMPC1265HP-470MG-D	47.0	6.5	9.5	76.00	90.00

Note:

1. Test frequency : L : 100KHz / 1.0V.
2. All test data referenced to 25°C ambient.
3. Heat Rated Current (I_{rms}) will cause the coil temperature rise approximately Δt of 40°C
4. Saturation Current (I_{sat}) will cause L0 to drop 30% typical.
5. Special inquiries besides the above common used types can be met on your requirement.

■ DC Bias Characteristics (Typical)

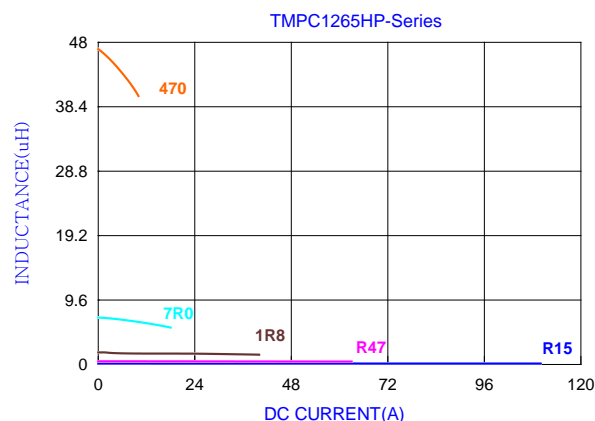
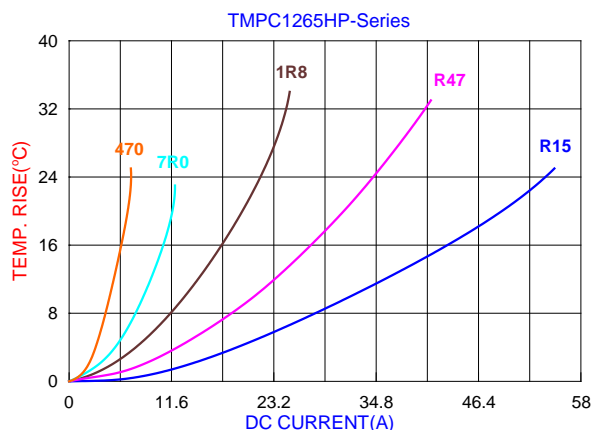

Molding Type High Current Power Inductors

TMPC 1707HP Series (6868 inch)

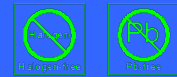

■ Dimensions

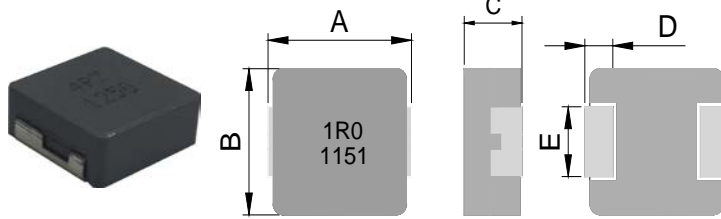

Chip Size	
A	17.60±0.40
B	16.90±0.30
C	6.70±0.30
D	2.10±0.30
E	11.90±0.30

Units: mm

■ Specifications

Part Number	Inductance L0 (uH)±20%	I rms (A)typ	I sat (A)typ	DCR (mΩ) typ. @25°C.	DCR (mΩ) max. @25°C.
TMPC1707HP-1R0MG-D	1.00	52.0	60.0	1.6	2.0
TMPC1707HP-2R2MG-D	2.20	43.5	47.0	2.4	2.7
TMPC1707HP-3R3MG-D	3.30	28.0	45.0	3.5	3.9
TMPC1707HP-4R7MG-D	4.70	25.0	41.0	4.8	5.5
TMPC1707HP-5R6MG-D	5.60	21.0	40.0	5.8	7.05
TMPC1707HP-6R8MG-D	6.80	19.0	32.0	8.4	9.2
TMPC1707HP-100MG-D	10.0	16.5	24.0	11.8	13.0
TMPC1707HP-220MG-D	22.0	12.0	18.0	25.1	26.5
TMPC1707HP-330MG-D	33.0	10.7	15.0	38.0	44.0
TMPC1707HP-470MG-D	47.0	8.7	9.5	48.0	55.0
TMPC1707HP-680MG-D	68.0	7.0	8.0	68.0	80.0
TMPC1707HP-101MG-D	100	5.3	6.5	102.0	118.0

Note:

1. Test frequency : L : 100KHz /1.0V.
2. All test data referenced to 25°C ambient.
3. Heat Rated Current (I_{rms}) will cause the coil temperature rise approximately Δt of 40°C
4. Saturation Current (I_{sat}) will cause L0 to drop 30% typical.
5. Special inquiries besides the above common used types can be met on your requirement.

■ DC Bias Characteristics (Typical)

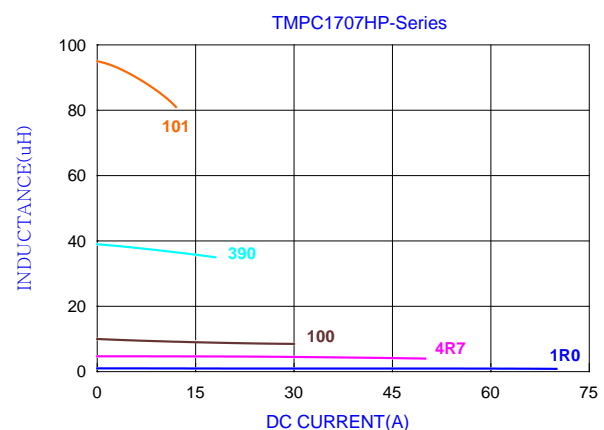
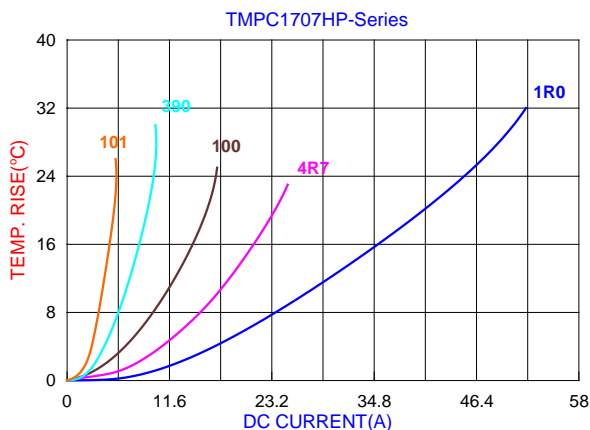

Molding Type High Current Power Inductors

TMPA 0503S Series (2020 inch)

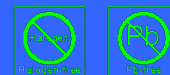

■ Dimensions

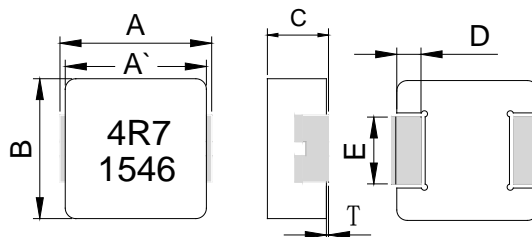

Series	A	A'	B	C	D	E	T
TMPA0503	5.7±0.3	5.2±0.3	5.2±0.2	2.8±0.2	1.0±0.3	2.0±0.2	0~0.15

Units: mm

■ Specifications

Part Number	Inductance L0 A(uH) ±20%	Heat Rating Current DC Typ (A) Irms.		Saturation Current DC Typ (A) Isat		DCR (mΩ) Typ	DCR (mΩ) Max
		Typ	Max	Typ	Max		
TMPA0503S-R47MN-D	0.47	13.5	12	10	9.0	5.2	6.0
TMPA0503S-R68MN-D	0.68	12.5	11	9.0	8.0	7.4	8.5
TMPA0503S-R82MN-D	0.82	10	9.0	8.8	7.7	8.0	9.2
TMPA0503S-1R0MN-D	1.00	9.0	8.0	8.5	7.5	10.5	12.0
TMPA0503S-1R5MN-D	1.50	8.0	7.0	7.5	6.5	13.6	15.7
TMPA0503S-2R2MN-D	2.20	7.0	6.5	6.5	5.8	21.6	25
TMPA0503S-3R3MN-D	3.30	6.3	5.8	6.0	5.3	28	33
TMPA0503S-4R7MN-D	4.70	5.5	4.8	5.3	4.6	38	44
TMPA0503S-5R6MN-D	5.60	5.0	4.3	4.6	4.0	50	58
TMPA0503S-6R8MN-D	6.80	4.3	3.7	3.5	3.1	57	66
TMPA0503S-100MN-D	10.0	3.8	3.4	2.5	2.1	88	103

Note:

1. Test frequency : Ls : 100KHz /1.0V.
2. All test data referenced to 25°C ambient.
3. Heat Rated Current (Irms) will cause the coil temperature rise approximately ΔT of 40°C
4. Saturation Current (Isat) will cause L0 to drop approximately 30%.

Molding Type High Current Power Inductors

TMPA 0503S Series (2020 inch)

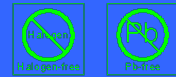

■ DC Bias Characteristics (Typical)

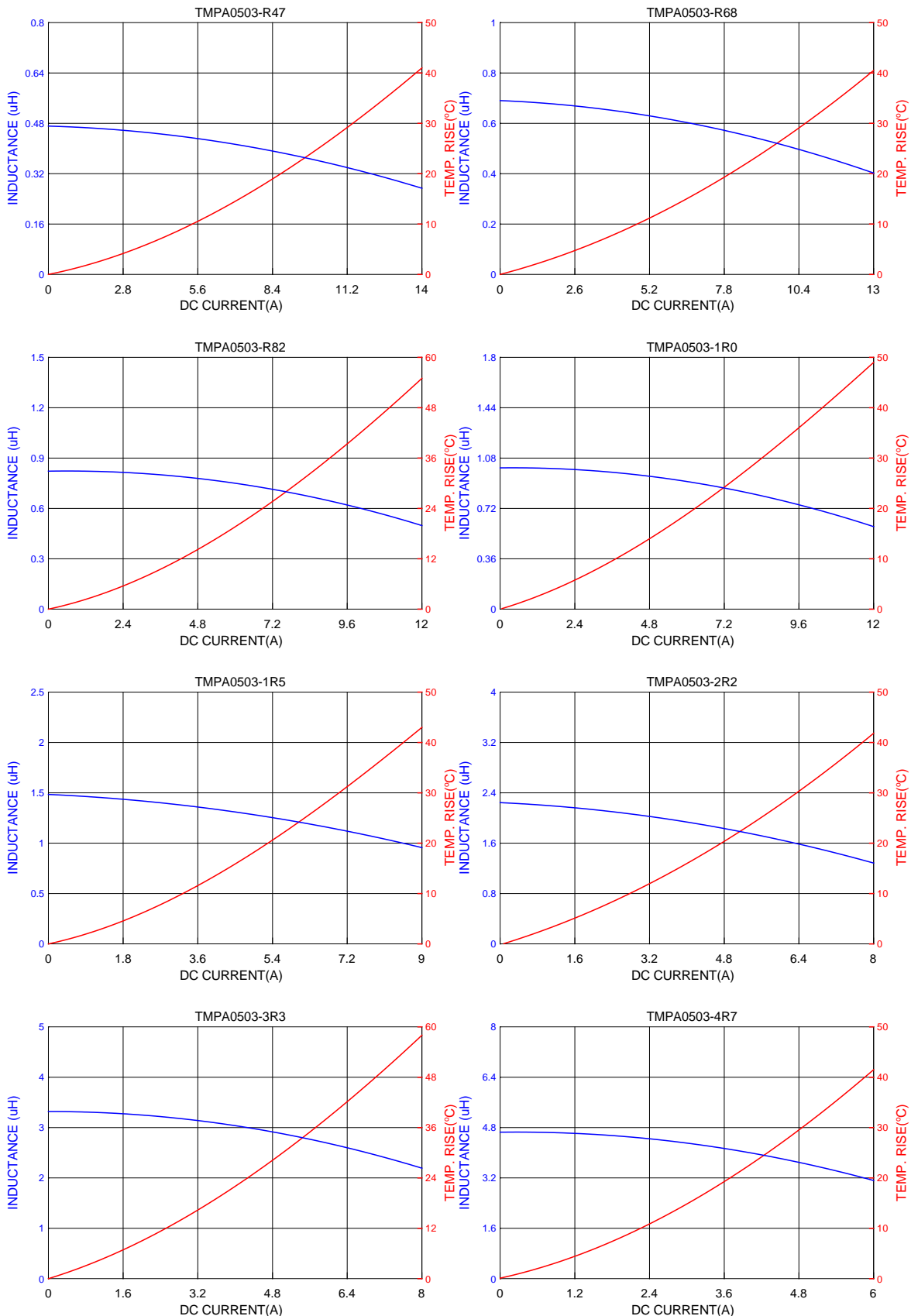



■ DC Bias Characteristics (Typical)

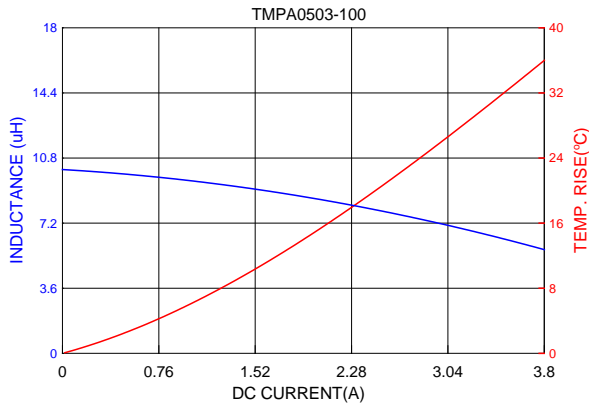
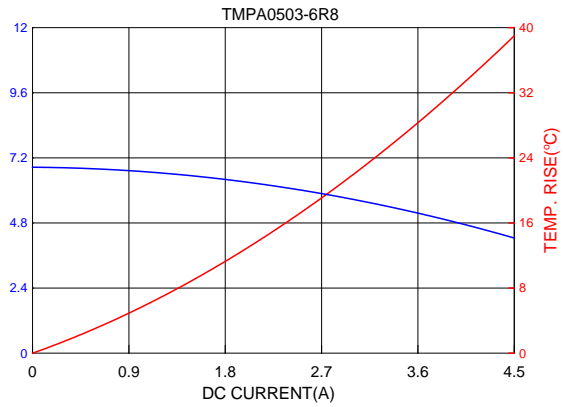
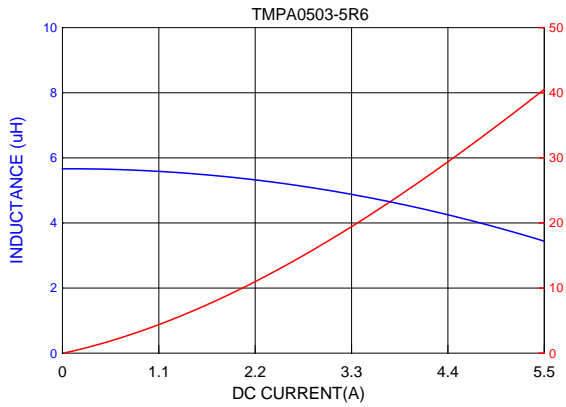

Molding Type High Current Power Inductors

TMPA 0603S Series (2424 inch)

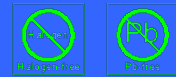

■ Dimensions

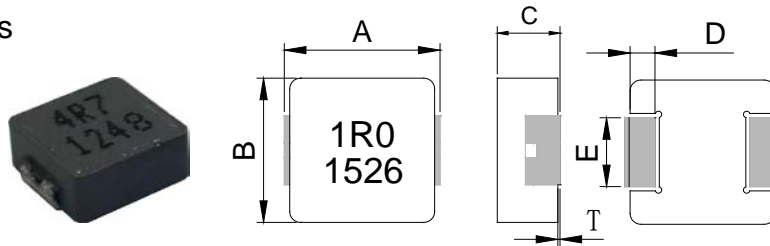

Series	A	B	C	D	E	T
TMPA0603	7.1±0.3	6.6±0.2	2.8±0.2	1.6±0.3	3.0±0.2	0~0.15

Units: mm

■ Specifications

Part Number	Inductance L0 A(uH) ±20%	Heat Rating Current DC Typ (A) Irms.	Saturation Current DC Typ (A) Isat	DCR (mΩ)Typ	DCR (mΩ)Max
TMPA0603S-R15YN-D	0.15±30%	30	40	1.7	2.1
TMPA0603S-R22MN-D	0.22	23	34	2.0	2.5
TMPA0603S-R33MN-D	0.33	21	25	2.8	3.4
TMPA0603S-R36MN-D	0.36	20	24	3.3	3.9
TMPA0603S-R47MN-D	0.47	18	20	3.4	4
TMPA0603S-R56MN-D	0.56	16.5	18	3.9	4.5
TMPA0603S-R68MN-D	0.68	16	17	4.7	5.3
TMPA0603S-R82MN-D	0.82	14	16	5.4	6.0
TMPA0603S-1R0MN-D	1.00	12	15	6.7	7.4
TMPA0603S-1R2MN-D	1.20	10	14	7.7	9.5
TMPA0603S-1R5MN-D	1.50	10	14	10.2	12.1
TMPA0603S-2R2MN-D	2.20	8	10	13.5	15
TMPA0603S-3R3MN-D	3.30	6.5	9.5	19	22
TMPA0603S-4R7MN-D	4.70	5.5	6.5	28	33
TMPA0603S-5R6MN-D	5.60	5.5	6	39	42
TMPA0603S-6R8MN-D	6.80	4.5	6	43	50
TMPA0603S-8R2MN-D	8.20	4.5	6	54	60
TMPA0603S-100MN-D	10.0	4	5.5	62	68
TMPA0603S-150MN-D	15.0	3	4.5	110	140
TMPA0603S-220MN-D	22.0	2.5	3	150	190

Note:

1. Test frequency : Ls : 100KHz /1.0V.
2. All test data referenced to 25°C ambient.
3. Heat Rated Current (Irms) will cause the coil temperature rise approximately ΔT of 40°C
4. Saturation Current (Isat) will cause L0 to drop approximately 30%.

Molding Type High Current Power Inductors

TMPA 0603S Series (2424 inch)



■ DC Bias Characteristics (Typical)

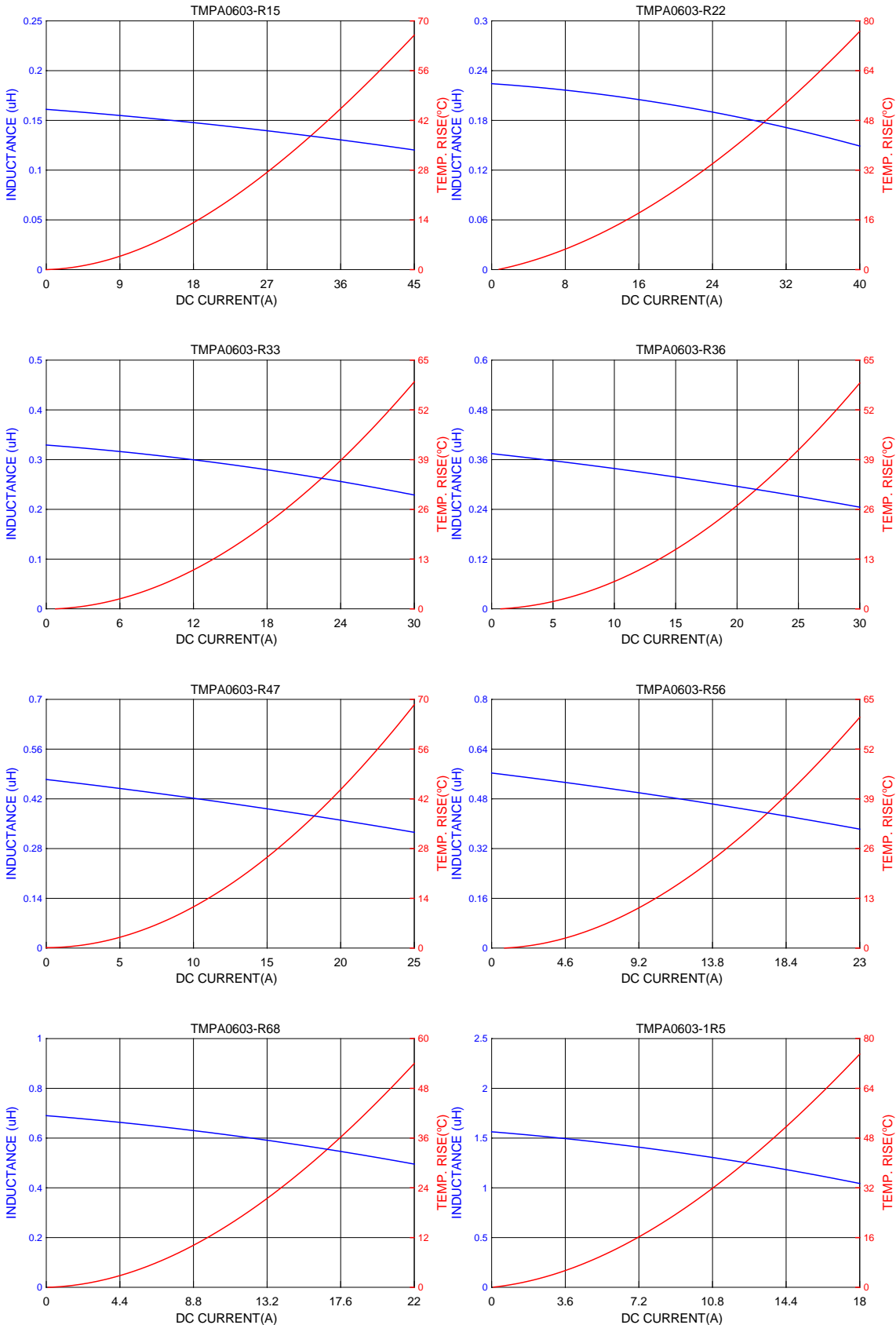

Molding Type High Current Power Inductors

TMPA 0603S Series (2424 inch)



■ DC Bias Characteristics (Typical)

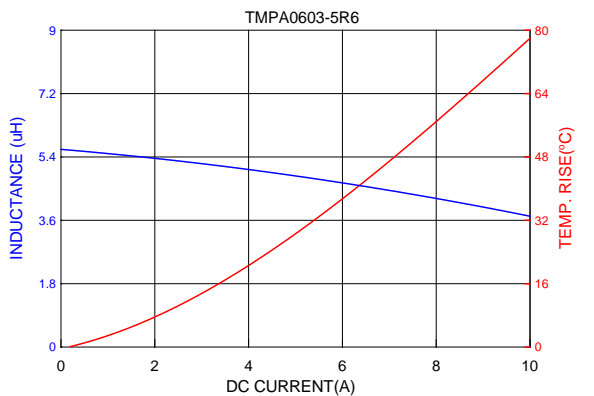
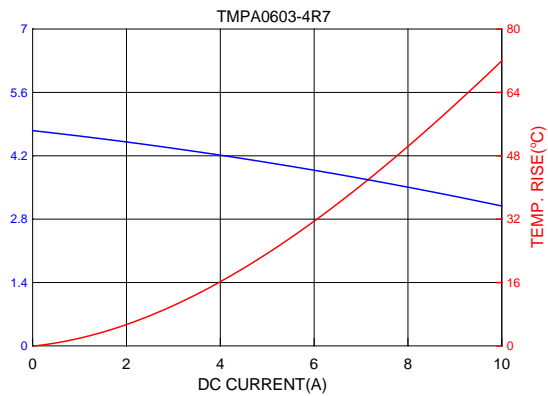
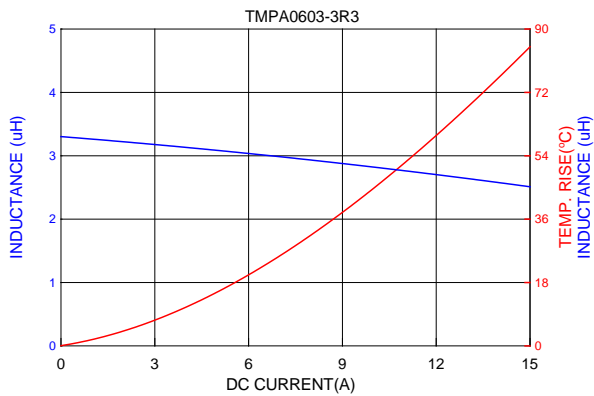
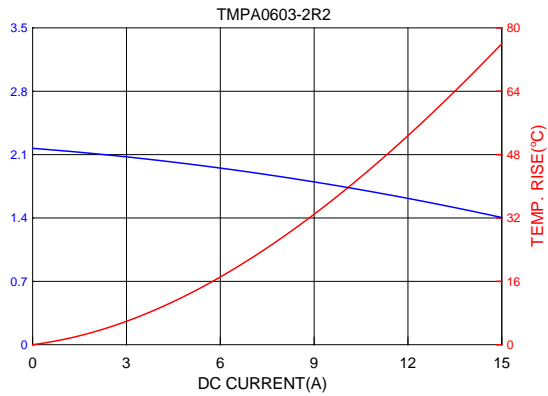
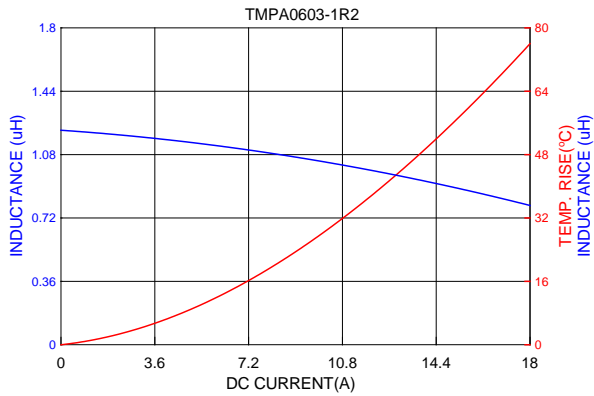
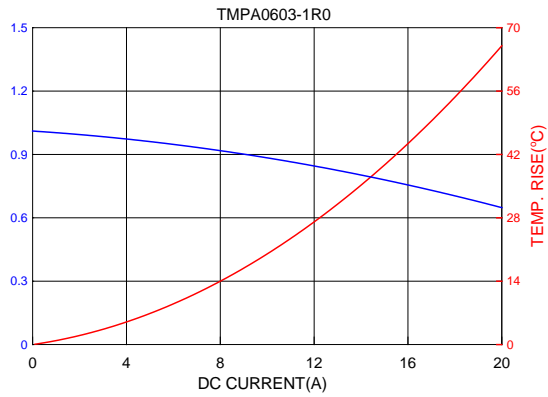
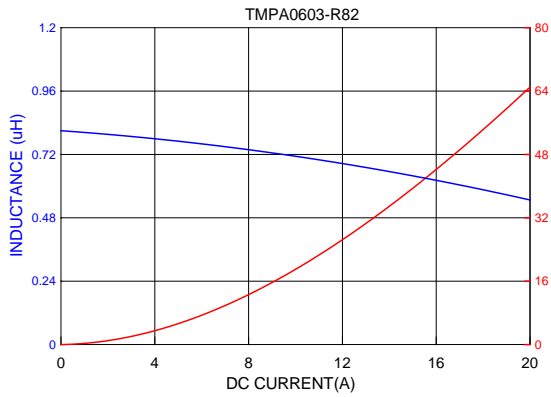

Molding Type High Current Power Inductors

TMPA 1004S Series (4040 inch)

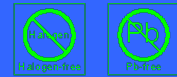

■ Dimensions

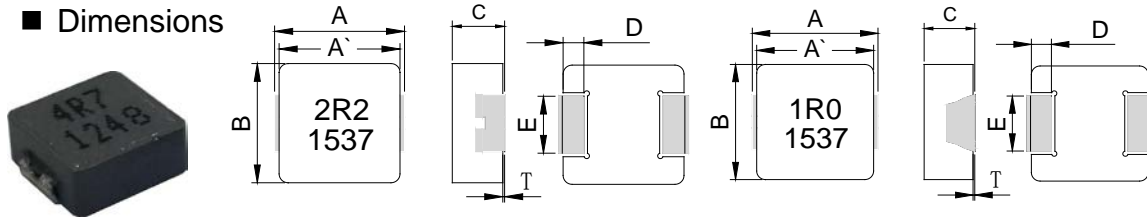

Lead Frame Type

Non Lead Frame Type

Series	A	A'	B	C	D	T	E	Inductance
TMPA1004	11.0±0.3	10.0±0.3	10.0±0.3	3.8±0.2	2.0±0.3	0~0.2	2.5±0.3	0.56~1.50uH
							3.0±0.3	0.47uH and below 2.00uH and above

Units: mm

■ Specifications

Part Number	Inductance LO A(uH) ±20%	Heat Rating Current DC I rms.(A)		Saturation Current DC I sat. (A)		DCR (mΩ)Typ	DCR (mΩ)Max	Type
		Typ	Max	Typ	Max			
TMPA1004S-R15YN-D	0.15±30%	44.0	38.0	82.0	75.0	0.50	0.60	non-leadframe
TMPA1004S-R22MN-D	0.22	36.0	33.0	70.0	60.0	0.72	0.83	non-leadframe
TMPA1004S-R36MN-D	0.36	33.0	29.0	51.0	45.0	1.05	1.18	non-leadframe
TMPA1004S-R42MN-D	0.42	32.5	28.5	50.0	42.0	1.15	1.30	non-leadframe
TMPA1004S-R47MN-D	0.47	32.0	28.0	46.0	40.0	1.30	1.50	non-leadframe
TMPA1004S-R56MN-D	0.56	25.0	23.0	34.0	29.0	1.60	1.80	non-leadframe
TMPA1004S-R68MN-D	0.68	23.0	20.0	31.0	28.0	1.90	2.20	non-leadframe
TMPA1004S-1R0MN-D	1.00	20.0	18.0	29.0	26.0	2.9	3.25	non-leadframe
TMPA1004S-1R5MN-D	1.50	17.5	16.0	26.0	22.0	3.7	4.2	non-leadframe
TMPA1004S-1R8MN-D	1.80	16.5	15.0	23.0	20.5	5.1	5.7	leadframe
TMPA1004S-2R0MN-D	2.00	16.0	14.5	21.0	18.0	5.3	6.1	leadframe
TMPA1004S-2R2MN-D	2.20	15.0	13.0	20.0	16.0	5.8	6.7	leadframe
TMPA1004S-3R3MN-D	3.30	11.0	10.0	17.5	14.0	10.5	11.8	leadframe
TMPA1004S-4R7MN-D	4.70	8.8	8.0	15.2	13.0	15.8	19.0	leadframe
TMPA1004S-5R6MN-D	5.60	8.0	7.2	14.1	11.5	19	22.8	leadframe
TMPA1004S-6R8MN-D	6.80	7.8	6.8	12.2	11.0	22	24.5	leadframe
TMPA1004S-8R2MN-D	8.20	7.6	6.5	9.5	8.5	25	28	leadframe
TMPA1004S-100MN-D	10.0	7.5	6.1	8.6	7.5	27	30	leadframe
TMPA1004S-150MN-D	15.0	6.25	5.0	7.0	6.0	41	45	leadframe
TMPA1004S-220MN-D	22.0	5.0	4.1	6.2	5.5	58	66	leadframe

Molding Type High Current Power Inductors

TMPA 1004S Series (4040 inch)

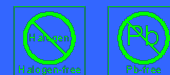

Part Number	Inductance L0 A(μH) ±20%	Heat Rating Current DC I rms.(A)		Saturation Current DC I sat. (A)		DCR (mΩ)Typ	DCR (mΩ)Max	Type
		Typ	Max	Typ	Max			
TMPA1004S-330MN-D	33.0	4.4	3.5	5.5	5.0	84	91	leadframe
TMPA1004S-470MN-D	47.0	3.5	3.0	4.0	3.7	125	143	leadframe
TMPA1004S-680MN-D	68.0	2.6	2.4	3.2	3.0	184	210	leadframe
TMPA1004S-820MN-D	82.0	2.3	2.1	3.0	2.8	240	270	leadframe
TMPA1004S-101MN-D	100	2.0	1.8	2.7	2.4	270	310	leadframe

- Note:
1. Test frequency : Ls : 100KHz /1.0V.
 2. All test data referenced to 25°C ambient.
 3. Heat Rated Current (I rms) will cause the coil temperature rise approximately ΔT of 40°C
 4. Saturation Current (Isat) will cause L0 to drop approximately 30%.

■ DC Bias Characteristics (Typical)

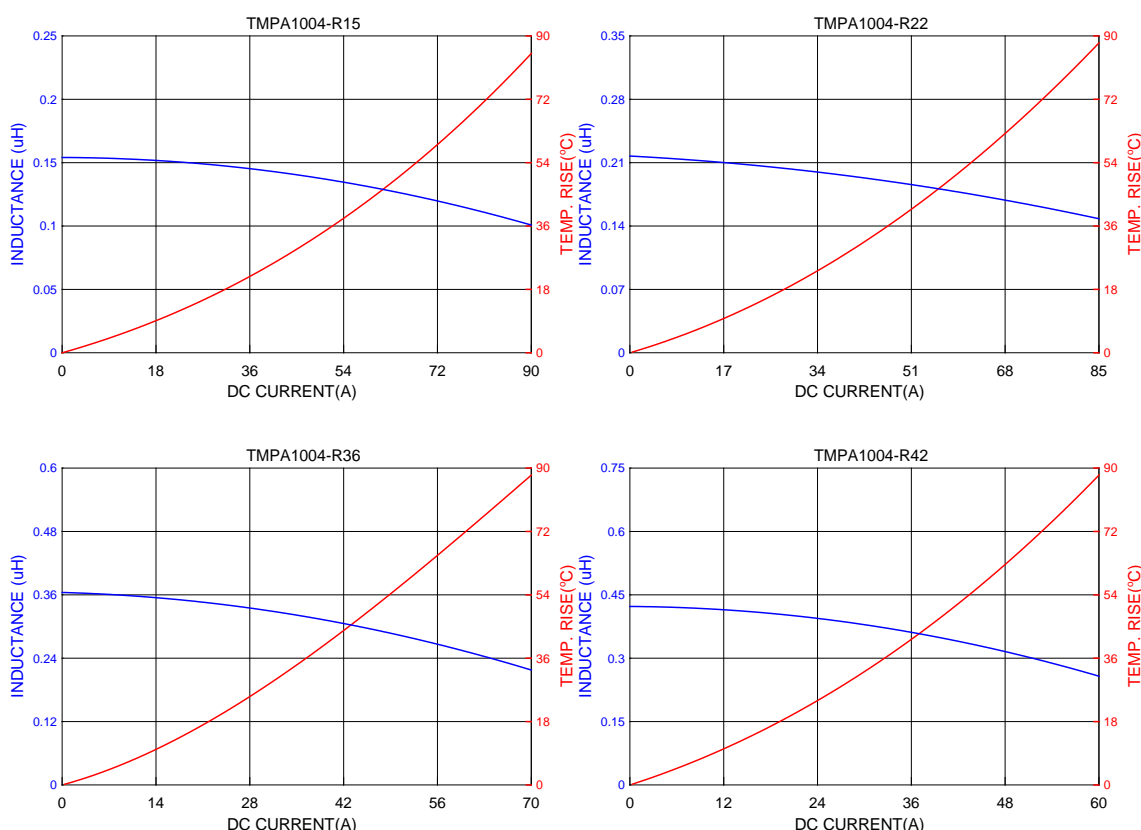



■ DC Bias Characteristics (Typical)

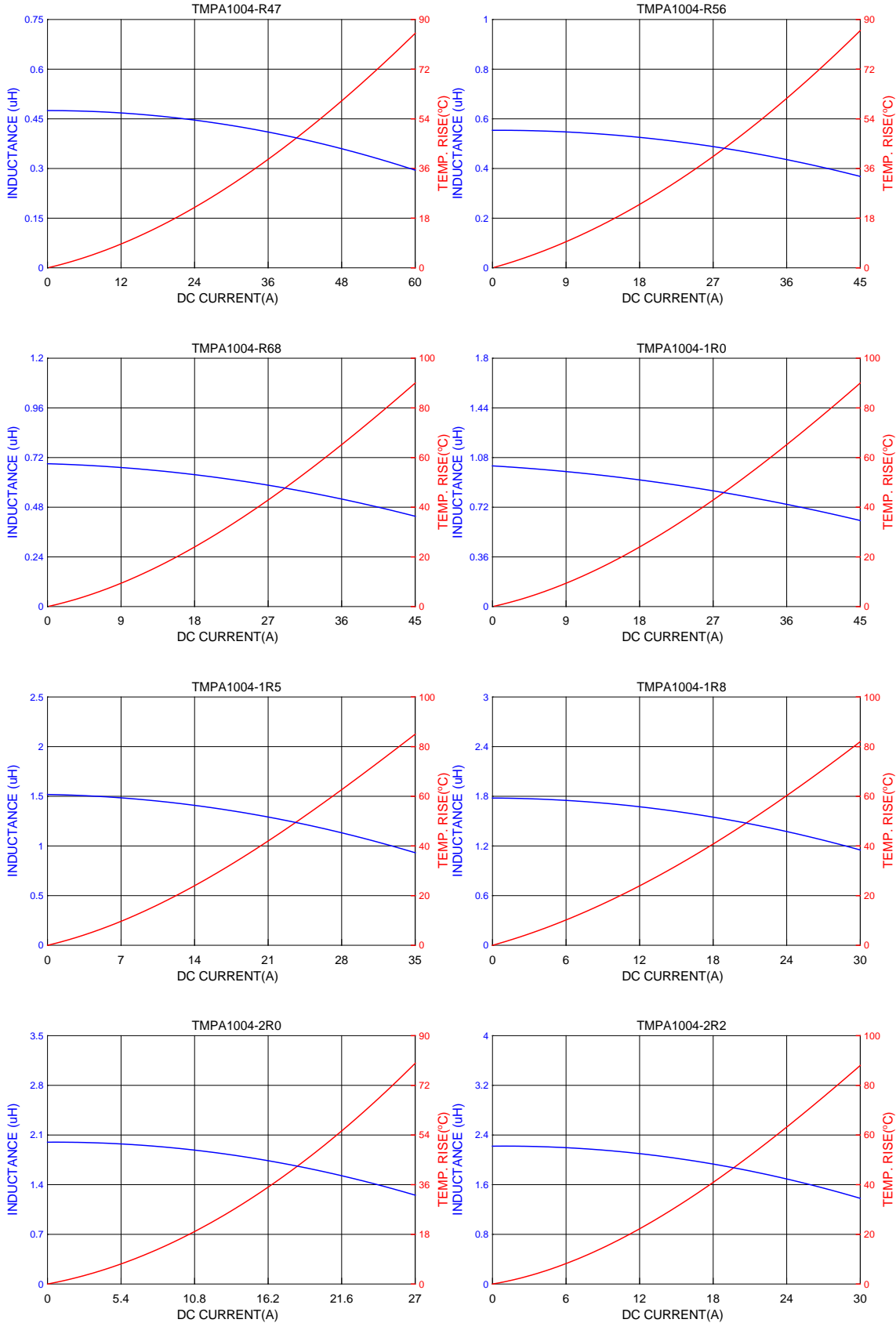

Molding Type High Current Power Inductors

TMPA 1004S Series (4040 inch)



■ DC Bias Characteristics (Typical)

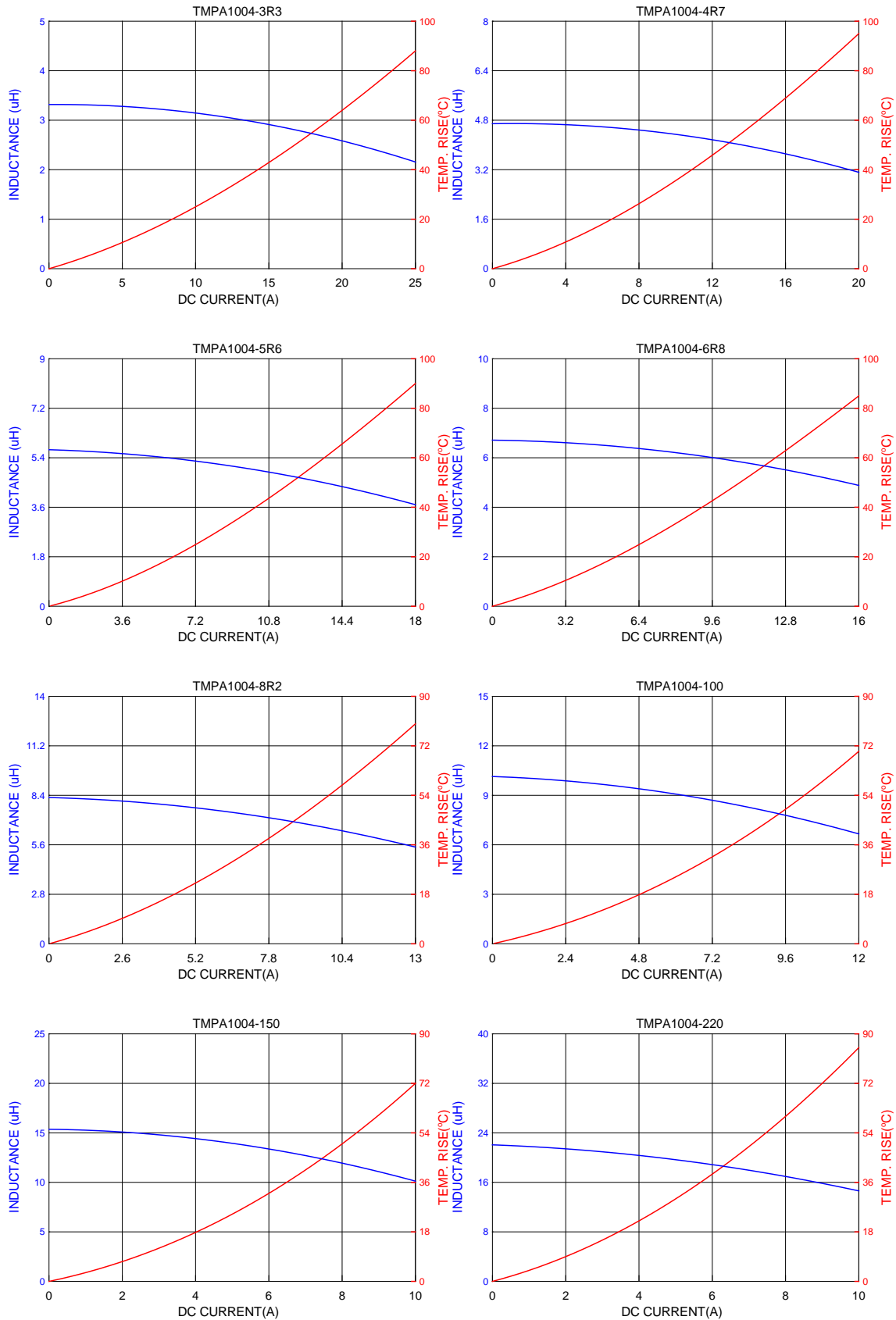

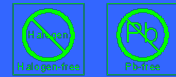

DC Bias Characteristics (Typical)

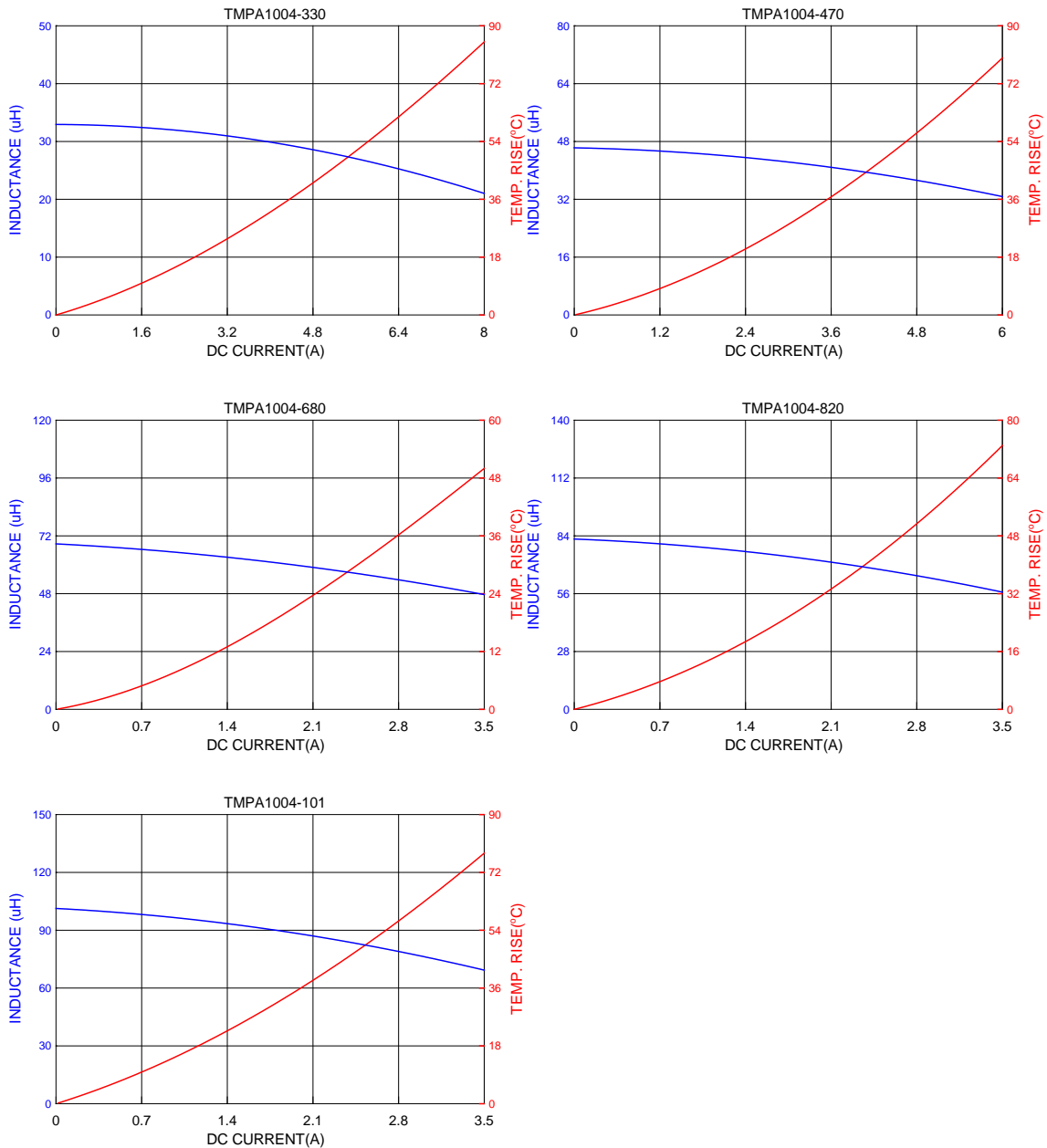

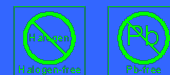

■ Dimensions

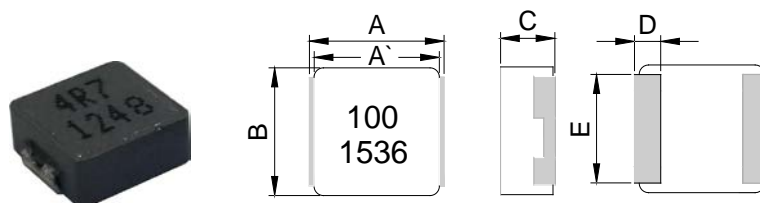

Series	A(mm)	A'(mm)	B(mm)	C(mm)	D(mm)	E(mm)
TMPA2313	23.5±0.5	22.7±0.3	22.0±0.3	12.6±0.4	5.0±0.4	19.0±0.3

Units: mm

■ Specifications

Part Number	Inductance L0 A(uH) ±20%	Heat Rating Current DC (A) Irms.		Saturation Current DC (A)I sat		DCR (mΩ) Typ	DCR (mΩ) Max
		Typ	Max	Typ	Max		
TMPA2313SP-1R5MN-D	1.50	62	57	52	48	1.00	1.15
TMPA2313SP-2R2MN-D	2.20	58	52	48	43	1.05	1.25
TMPA2313SP-3R3MN-D	3.30	49	47	41	37	1.50	1.75
TMPA2313SP-4R7MN-D	4.70	47	44	38	34	1.90	2.20
TMPA2313SP-6R8MN-D	6.80	40	36	36	32	2.70	3.10
TMPA2313SP-100MN-D	10.0	33	30	28	20	3.80	4.15
TMPA2313SP-220MN-D	22.0	22	18	15	14	9.20	11.0
TMPA2313SP-230MN-D	23.0	22	18	15	14	9.20	11.0
TMPA2313SP-330MN-D	33.0	19	16	12	10.5	13.5	15.4
TMPA2313SP-470MN-D	47.0	17	14	12	10.0	17.3	20.8
TMPA2313SP-680MN-D	68.0	14	12	12	9.0	26.2	29.5
TMPA2313SP-750MN-D	75.0	13	11	10.5	8.5	27.5	31.6
TMPA2313SP-820MN-D	82.0	12	10	9.0	7.7	31.0	34.2
TMPA2313SP-101MN-D	100	11	9.5	9.0	7.5	36.0	40.0

Note:

1. Test frequency : Ls : 100KHz /1.0V.
2. All test data referenced to 25°C ambient.
3. Heat Rated Current (Irms) will cause the coil temperature rise approximately ΔT of 40°C
4. Saturation Current (Isat) will cause L0 to drop approximately 30%.

Molding Type High Current Power Inductors

TMPA 2313SP Series (9090 inch)



DC Bias Characteristics (Typical)

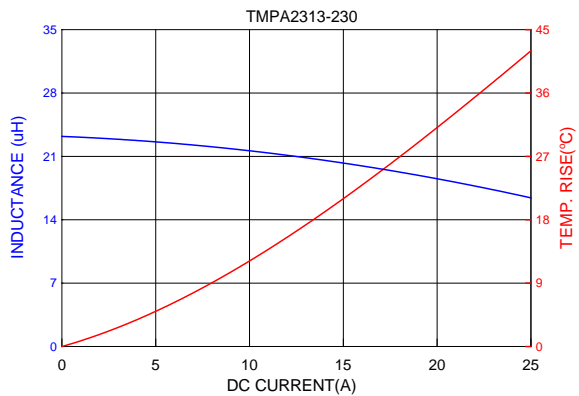
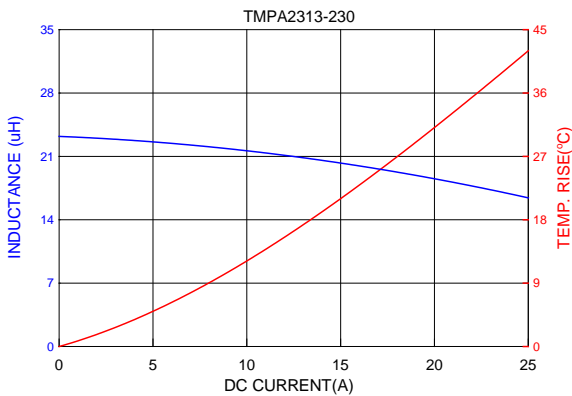
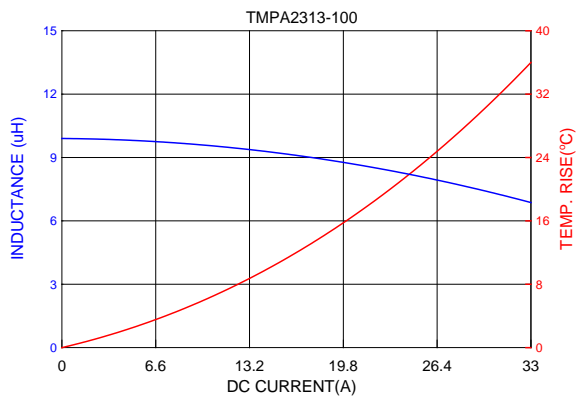
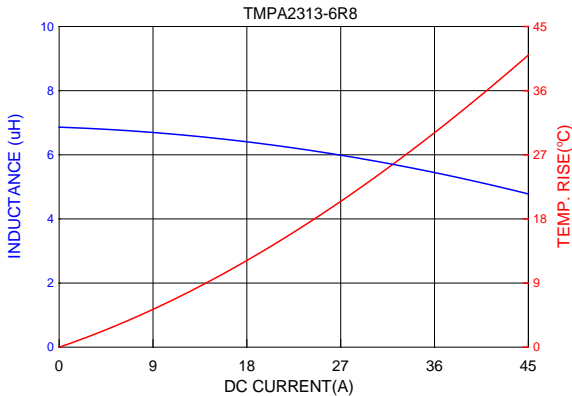
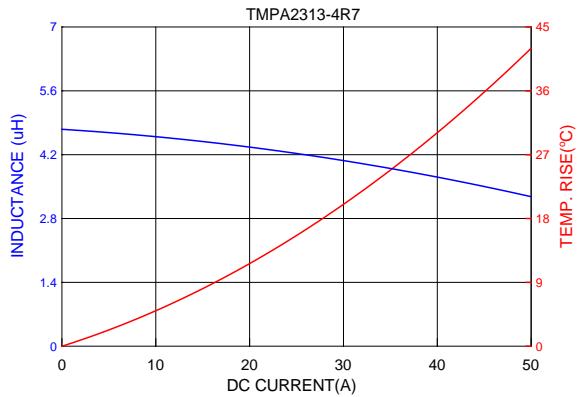
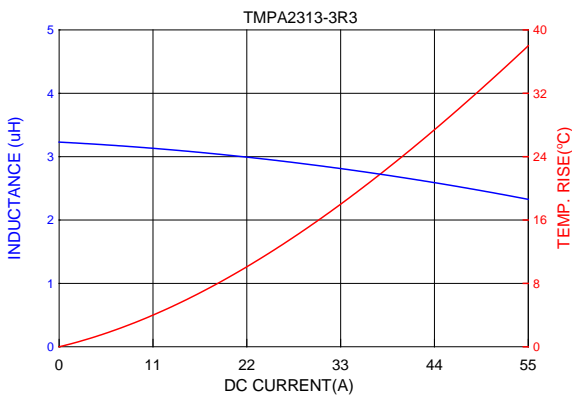
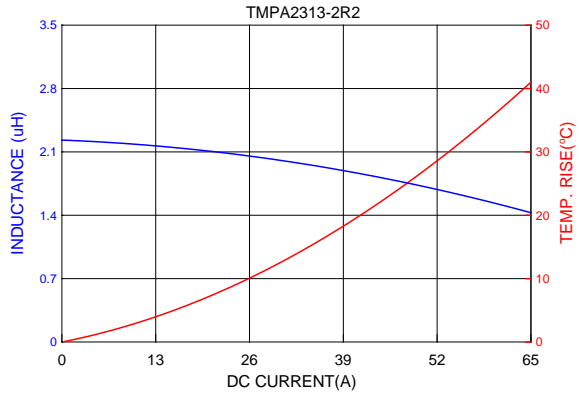
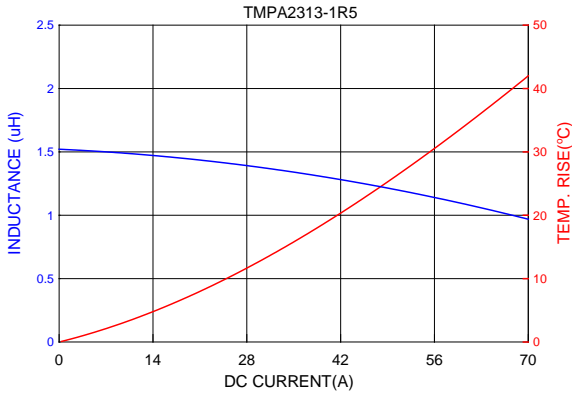

Molding Type High Current Power Inductors

TMPA 2313SP Series (9090 inch)



■ DC Bias Characteristics (Typical)

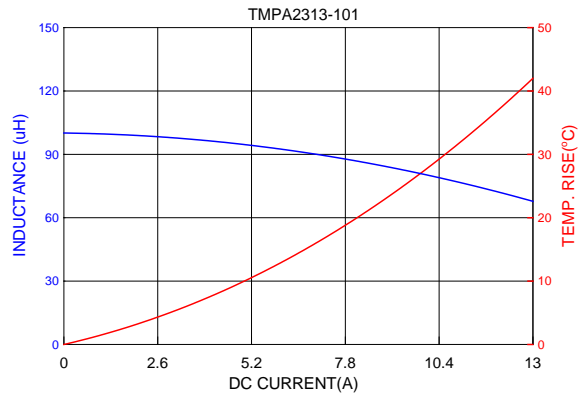
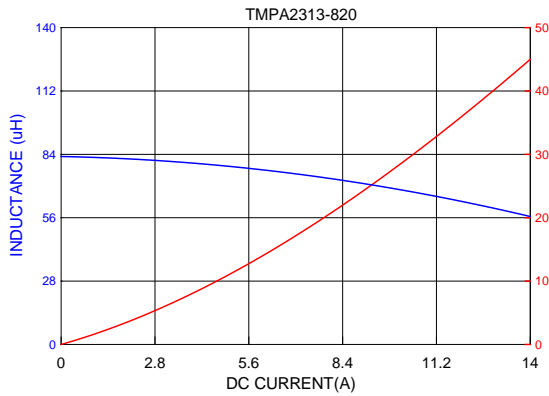
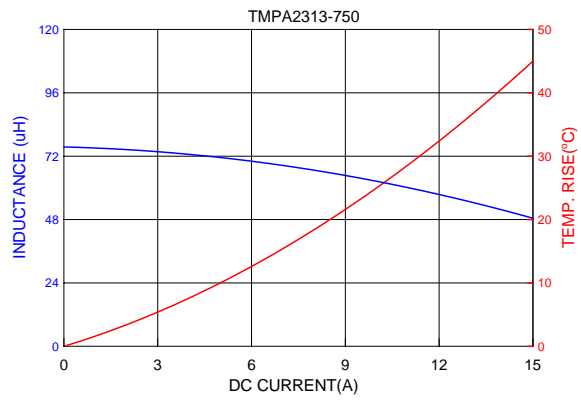
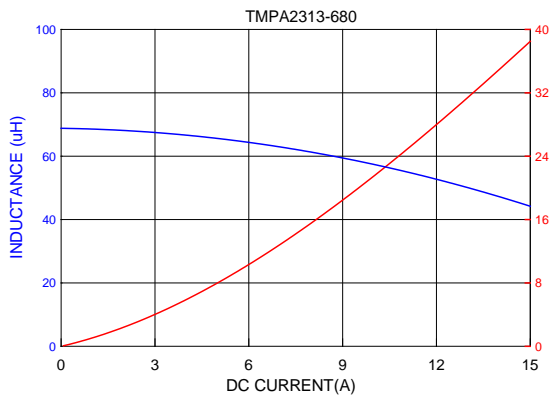
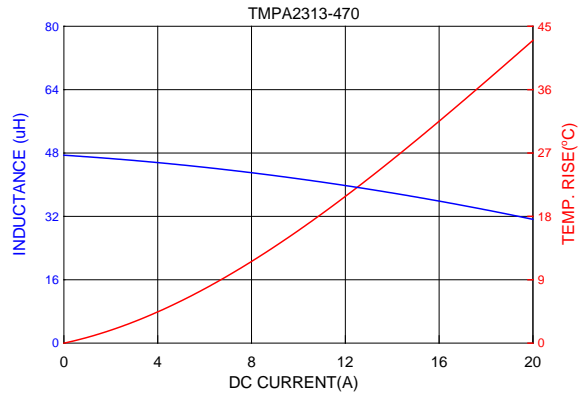
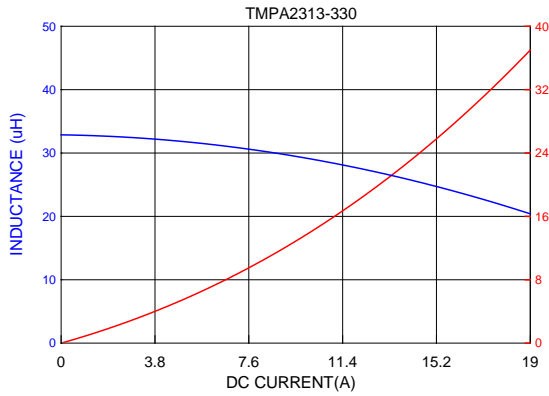

Molding Type High Current Power Inductors

TMPF0402LR Series (1616 inch)

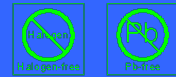

■ Dimensions

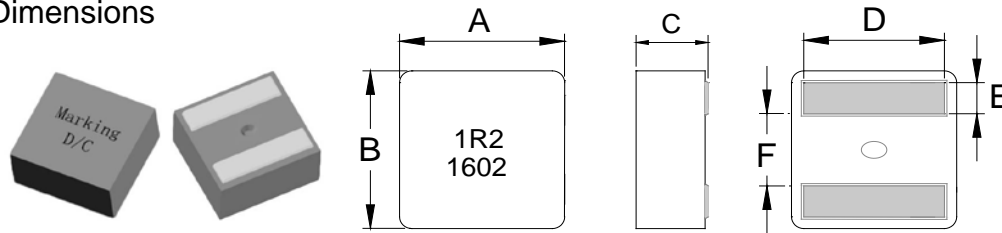

Series	A (mm)	B (mm)	C (mm)	D (mm)	E (mm)	F (mm)
TMPF0402LR	4.1±0.2	4.1±0.2	1.9±0.2	3.4±0.3	0.88±0.2	1.6±0.25

■ Specifications

Part Number	Inductance (uH) ±20% @ 0 A	I rms(A) Typ		I sat(A)				DCR(mΩ) Typ.	DCR(mΩ) Max.
		20°C rise	40°C rise	Typ			Max		
				1	2	3			
TMPF0402LR-R47MN-D	0.47	9.8	13.2	7.0	10.0	14.0	12.5	6.00	6.8
TMPF0402LR-R68MN-D	0.68	9.2	12.0	5.2	8.0	11.6	10.0	7.30	8.2
TMPF0402LR-R82MN-D	0.82	8.5	11.5	4.8	6.5	10.2	9.0	8.60	9.5
TMPF0402LR-1R0MN-D	1.00	8.0	11.0	4.5	5.4	9.2	8.0	10.60	11.7
TMPF0402LR-1R2MN-D	1.20	7.2	9.5	4.3	5.0	8.6	7.5	12.20	13.4
TMPF0402LR-1R5MN-D	1.50	6.7	9.1	4.1	4.5	7.5	6.7	14.40	15.8
TMPF0402LR-2R0MN-D	2.00	6.2	8.2	3.2	4.0	6.2	5.0	21.15	23.3
TMPF0402LR-2R2MN-D	2.20	6.0	8.0	3.1	3.8	6.0	4.8	21.35	23.5
TMPF0402LR-3R3MN-D	3.30	4.4	5.5	2.7	3.4	5.3	4.4	34.2	38.3
TMPF0402LR-4R7MN-D	4.70	3.8	5.1	2.0	2.7	4.0	3.5	52.0	57.2

Note:

1. Test frequency : L : 100KHz /0.1V.
2. All test data referenced to 25°C ambient.
3. Testing Instrument : L: HP4284A,HP4395A,CH11025,CH3302,CH1320 ,CH1320S LCR METER / Rdc:CH16502,Agilent33420A MICRO OHMMETER,or EQU.
4. Current that causes the specified temperature rise from 25°C ambient.
5. Saturation Current (Isat 1) will cause L0 to drop approximately 10%.
Saturation Current (Isat 2) will cause L0 to drop approximately 20%.
Saturation Current (Isat 3) will cause L0 to drop approximately 30%.



■ DC Bias Characteristics (Typical)

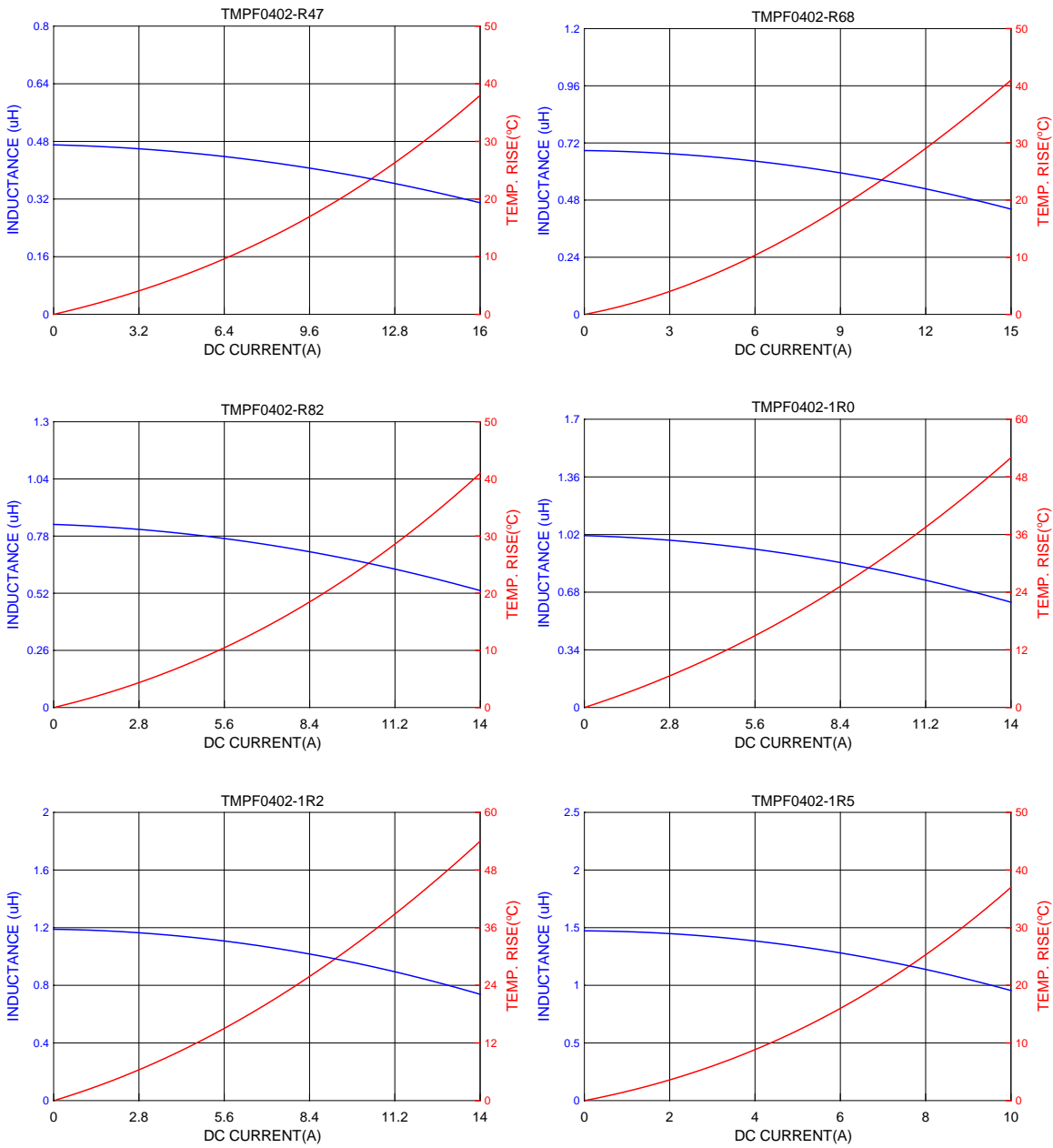



■ DC Bias Characteristics (Typical)

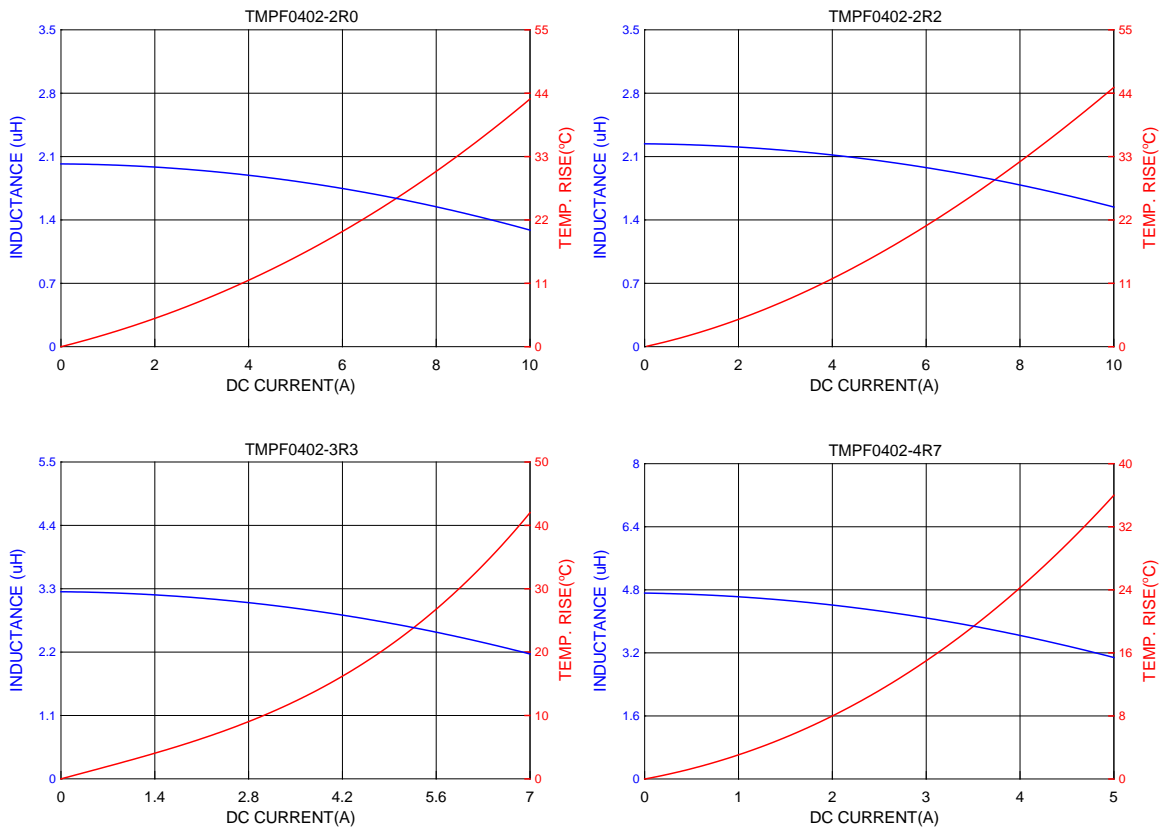



■ Dimensions

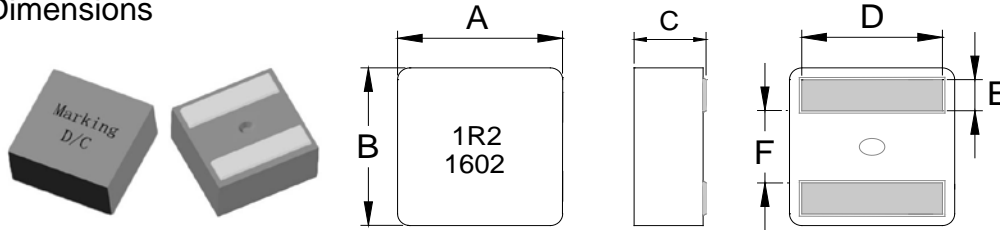

Series	A (mm)	B (mm)	C (mm)	D (mm)	E (mm)	F (mm)
TMPF0402A	4.1±0.2	4.1±0.2	1.9±0.2	3.4±0.3	0.88±0.2	1.6±0.25

■ Specifications

Part Number	Inductance (uH) ±20% @ 0 A	I rms(A) Typ		I sat(A)		DCR (mΩ) Typ.	DCR (mΩ) Max.
		20°C rise	40°C rise	Typ	Max		
TMPF0402A-R10MN-D	0.10	13.5	18.0	38.0	33.0	2.2	2.42
TMPF0402A-R22MN-D	0.22	13.0	16.8	19.5	18.8	4.1	4.60
TMPF0402A-R36MN-D	0.36	11.0	14.5	17.0	15.0	5.6	6.30
TMPF0402A-R40MN-D	0.40	10.0	14.0	15.5	13.5	6.9	7.73
TMPF0402A-R56MN-D	0.56	8.5	12.0	14.0	12.6	8.4	9.30
TMPF0402A-R60MN-D	0.60	8.0	11.7	13.7	12.3	8.6	9.52
TMPF0402A-R72MN-D	0.72	7.6	10.5	12.0	10.6	10.4	11.6
TMPF0402A-1R0MN-D	1.00	6.8	9.6	9.6	8.8	13.3	14.6
TMPF0402A-1R2MN-D	1.20	6.6	9.0	9.0	7.8	16.2	17.9
TMPF0402A-1R5MN-D	1.50	5.8	7.6	8.0	7.4	21.0	23.5
TMPF0402A-1R8MN-D	1.80	5.2	7.0	7.5	7.0	25.0	28.0
TMPF0402A-2R2MN-D	2.20	4.6	5.6	6.5	6.0	35.2	38.7

Note:

1. Test frequency : L : 100KHz /0.1V.
2. All test data referenced to 25°C ambient.
3. Current that causes the specified temperature rise from 25°C ambient.
4. Saturation Current (Isat 3) will cause L0 to drop approximately 30%.

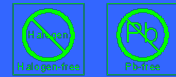

DC Bias Characteristics (Typical)

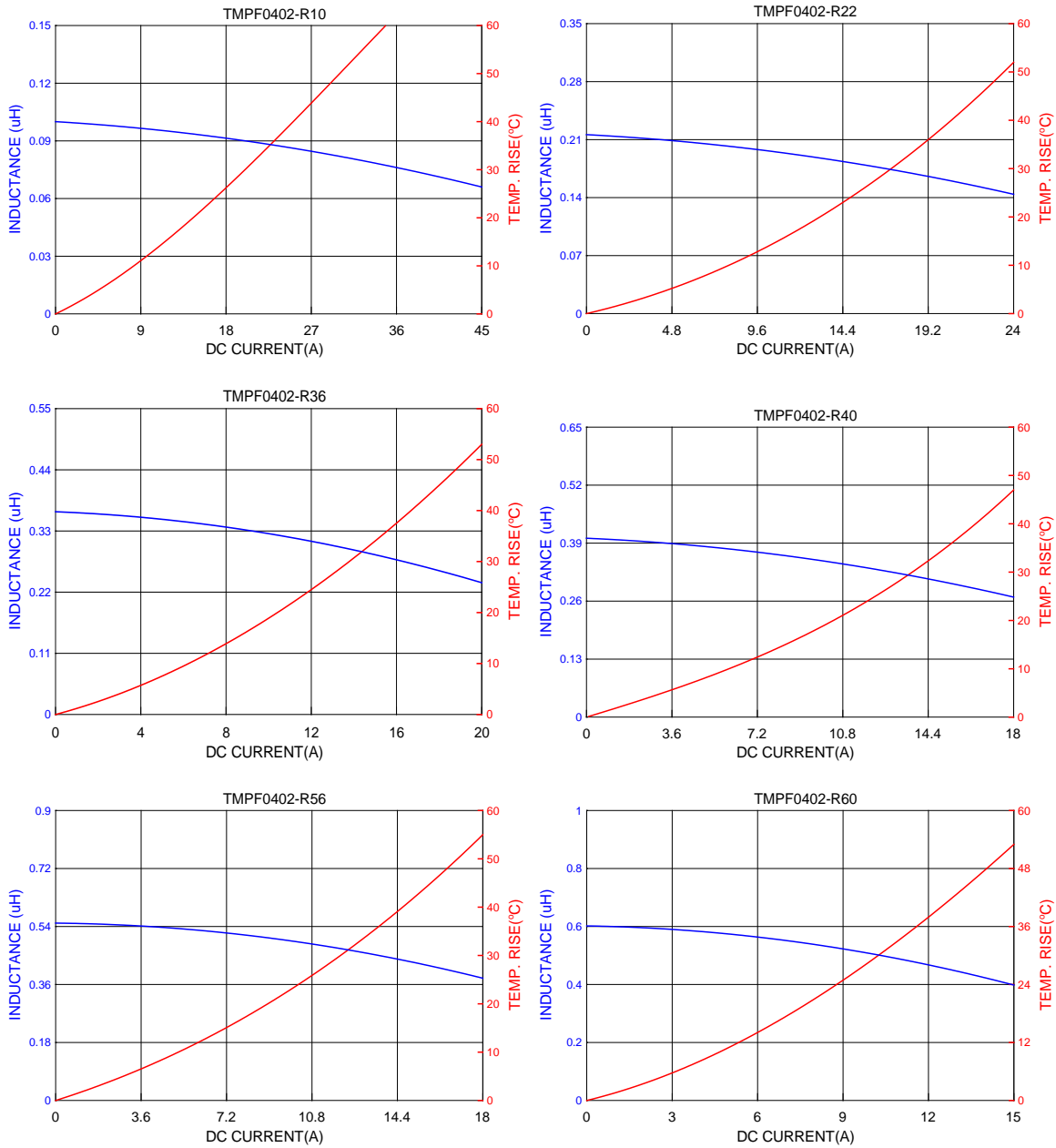

Molding Type High Current Power Inductors

TMPF0402A Series (1616 inch)



■ DC Bias Characteristics (Typical)

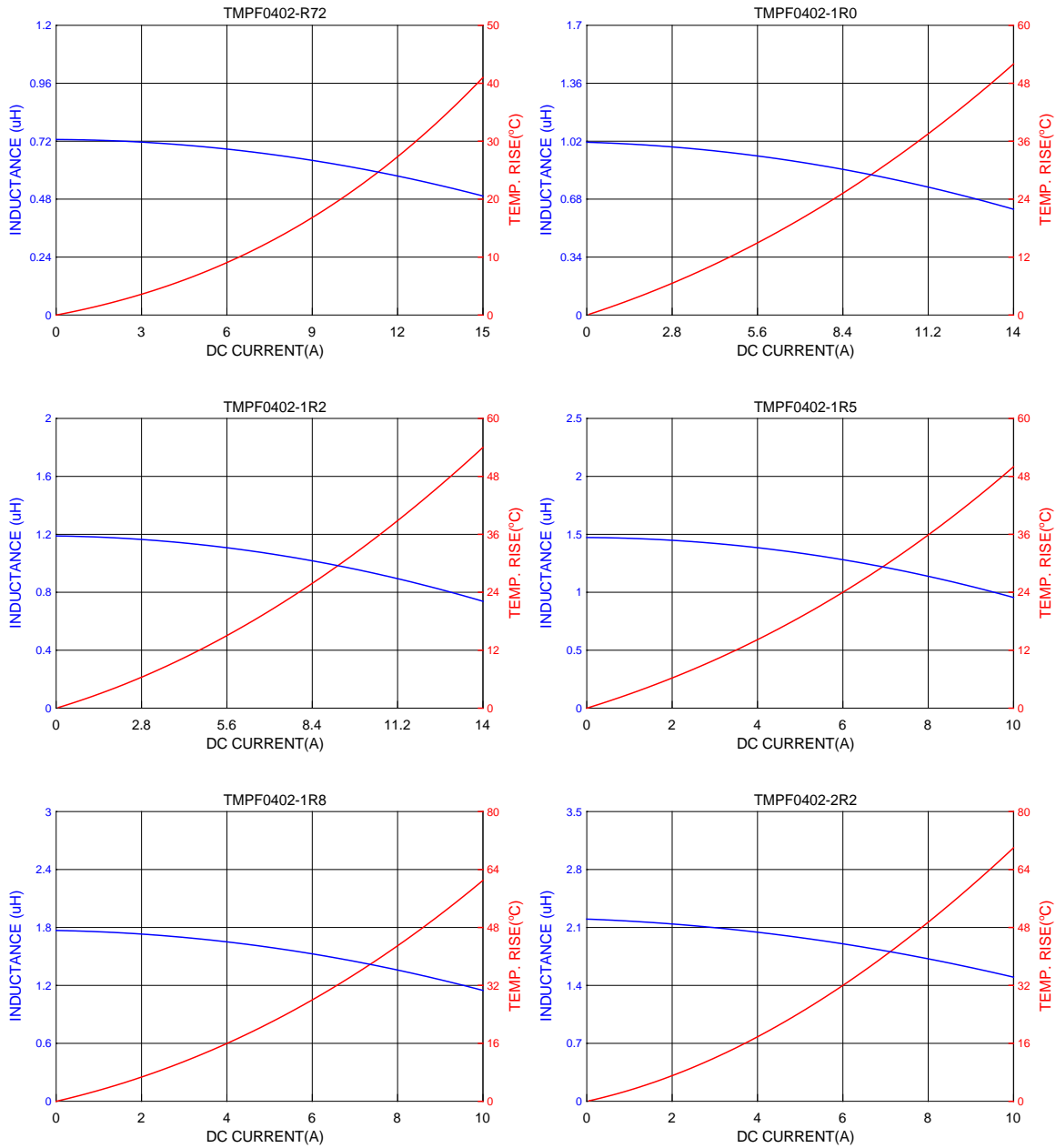

Molding Type High Current Power Inductors

TMPF0502A Series (2020 inch)

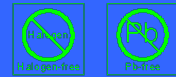

■ Dimensions

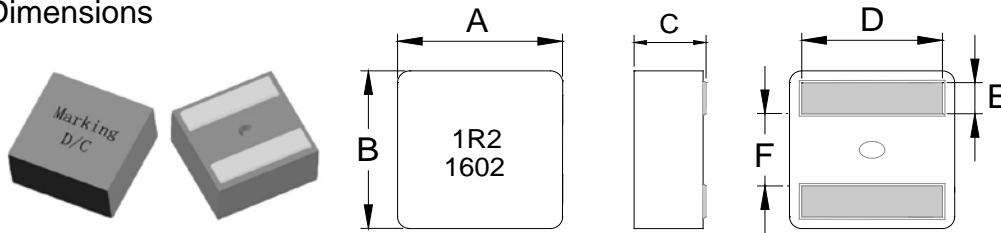

Series	A (mm)	B (mm)	C (mm)	D (mm)	E (mm)	F (mm)
TMPF0502A	5.5±0.2	5.3±0.2	1.9±0.2	4.3±0.3	1.1±0.2	2.3±0.25

■ Specifications

Part Number	Inductance (uH) ±20% @ 0 A	I rms(A) Typ		I sat(A)		DCR(mΩ) Typ.	DCR(mΩ) Max.
		20°C rise	40°C rise	Typ	Max		
TMPF0502A-R15MN-D	0.15	13.9	18.8	30.0	27.0	4.00	4.60
TMPF0502A-R16MN-D	0.16	13.9	18.8	30.0	27.0	4.00	4.60
TMPF0502A-R33MN-D	0.33	10.5	14.4	26.0	24.0	6.10	7.00
TMPF0502A-R47MN-D	0.47	10.1	14.1	22.0	20.0	7.00	8.05
TMPF0502A-R56MN-D	0.56	9.9	13.9	19.0	16.0	8.70	9.54
TMPF0502A-R68MN-D	0.68	9.6	13.4	16.0	14.0	8.90	10.2
TMPF0502A-R80MN-D	0.80	9.4	13.0	15.5	13.5	10.3	11.8
TMPF0502A-R82MN-D	0.82	8.5	12.0	15.0	13.0	11.0	12.7
TMPF0502A-1R0MN-D	1.00	7.5	10.5	14.5	12.8	12.0	13.8
TMPF0502A-1R2MN-D	1.20	6.8	9.40	14.0	12.2	14.2	16.3
TMPF0502A-1R5MN-D	1.50	6.4	8.80	13.3	11.7	16.2	18.7

Note:

1. Test frequency : L : 100KHz /0.1V.
2. All test data referenced to 25°C ambient.
3. Testing Instrument : L/Q: HP4284A,HP4395A,CH11025,CH3302,CH1320 ,CH1320S LCR METER / Rdc:CH16502,Agilent33420A MICRO OHM METER,or EQU.
4. Current that causes the specified temperature rise from 25°C ambient.
5. Saturation Current (Isat) will cause L0 to drop approximately 30%.



■ DC Bias Characteristics (Typical)

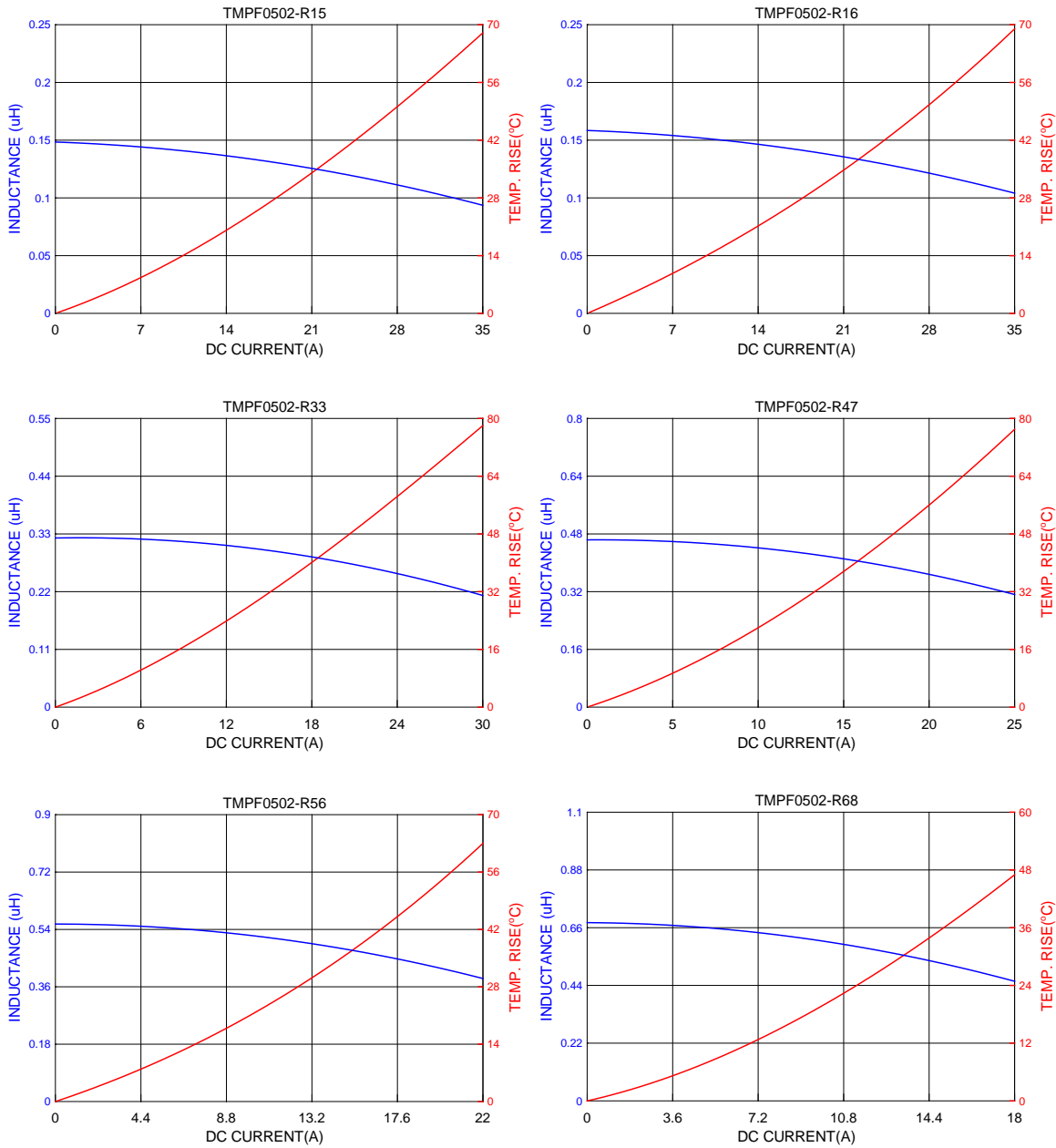



■ DC Bias Characteristics (Typical)

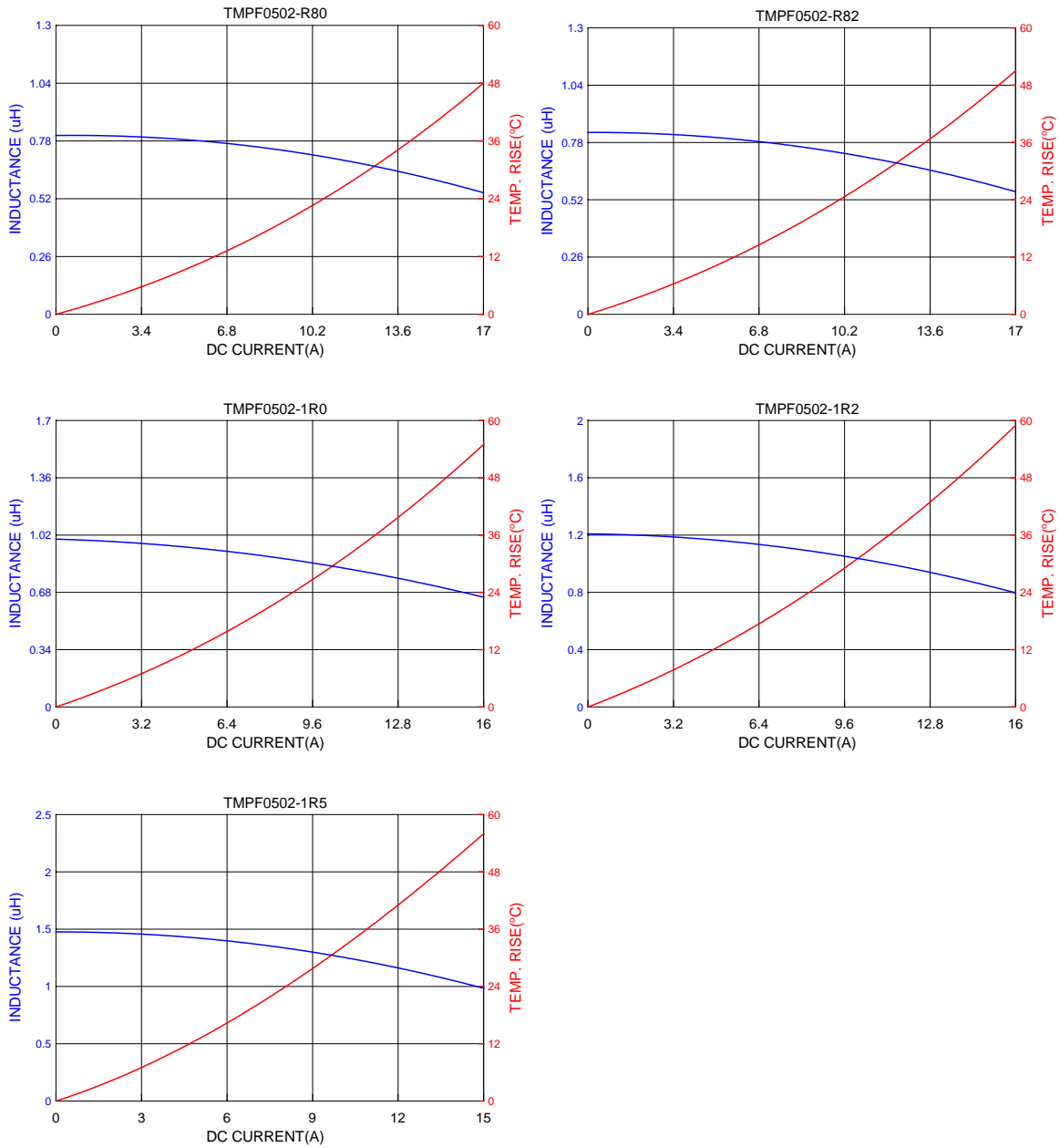

Molding Type High Current Power Inductors

TMPF0503A Series (2020 inch)

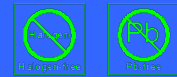

■ Dimensions

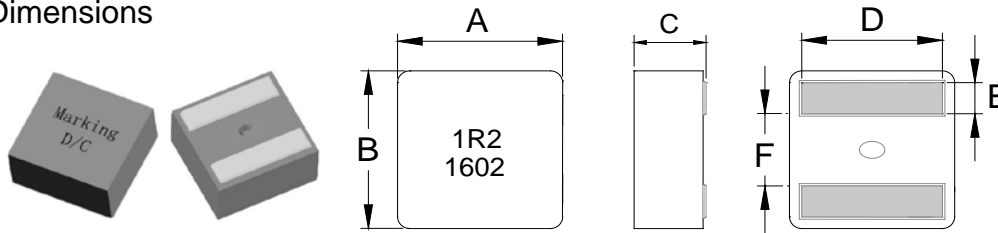

Series	A (mm)	B (mm)	C (mm)	D (mm)	E (mm)	F (mm)
TMPF0503A	5.5±0.2	5.3±0.2	2.9±0.2	4.3±0.3	1.1±0.2	2.3±0.25

■ Specifications

Part Number	Inductance (uH) ±20% @ 0 A	I rms(A) Typ		I sat(A)		DCR(mΩ) Typ.	DCR(mΩ) Max.
		20°C rise	40°C rise	Typ	Max		
TMPF0503A-R15MN-D	0.15	14.3	22.2	36.0	32.5	2.10	2.31
TMPF0503A-R16MN-D	0.16	14.2	22.2	35.0	32.0	2.12	2.33
TMPF0503A-R33MN-D	0.33	13.8	19.2	28.0	26.0	3.20	3.52
TMPF0503A-R47MN-D	0.47	13.7	18.4	26.0	24.0	3.75	4.13
TMPF0503A-R56MN-D	0.56	13.6	17.7	22.2	20.2	4.05	4.52
TMPF0503A-R60MN-D	0.60	13.6	17.7	22.0	20.0	4.11	4.52
TMPF0503A-R80MN-D	0.80	10.1	13.1	20.0	18.0	5.14	5.65
TMPF0503A-R82MN-D	0.82	9.90	12.9	19.7	17.6	5.25	5.78
TMPF0503A-1R0MN-D	1.00	9.00	12.2	16.5	14.3	6.90	7.60
TMPF0503A-1R2MN-D	1.20	8.50	11.0	15.0	13.5	8.80	9.70
TMPF0503A-1R5MN-D	1.50	8.00	10.5	14.0	12.5	10.1	11.2
TMPF0503A-1R8MN-D	1.80	7.60	10.1	12.3	11.3	11.5	12.7
TMPF0503A-2R2MN-D	2.20	7.20	9.70	10.0	9.0	13.2	14.5
TMPF0503A-3R3MN-D	3.30	5.90	8.10	9.5	8.7	21.0	23.1
TMPF0503A-4R7MN-D	4.70	4.30	5.90	8.2	7.0	33.0	36.3

Note:

1. Test frequency : L : 100KHz /0.1V.
2. All test data referenced to 25°C ambient.
3. Testing Instrument : L/Q: HP4284A,HP4395A,CH11025,CH3302,CH1320 ,CH1320S LCR METER / Rdc:CH16502, Agilent33420A MICRO OHM METER ,or EQU.
4. Current that causes the specified temperature rise from 25°C ambient.
5. Saturation Current (Isat) will cause L0 to drop approximately 30%.

Molding Type High Current Power Inductors

TMPF0503A Series (2020 inch)



DC Bias Characteristics (Typical)

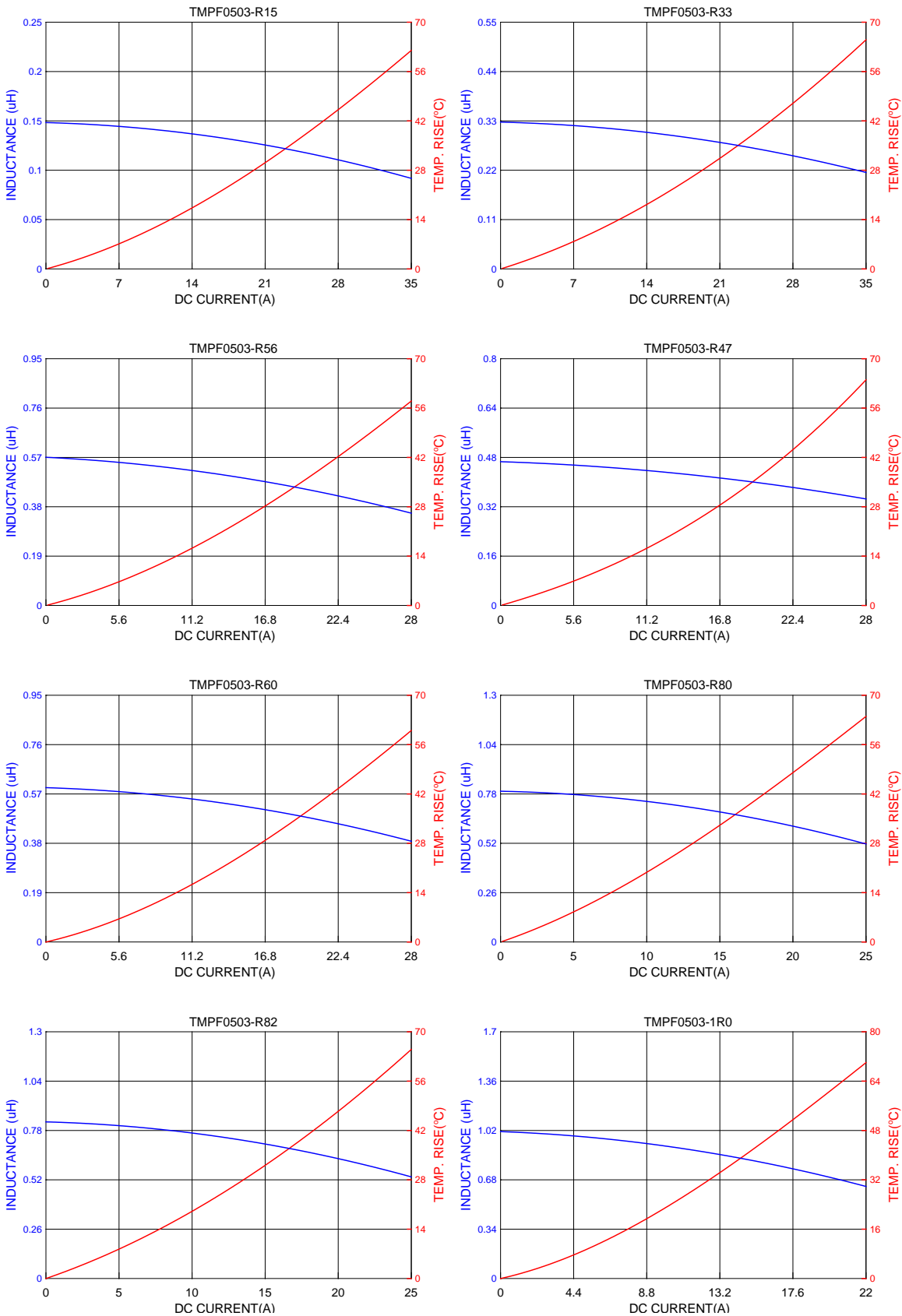

Molding Type High Current Power Inductors

TMPF0503A Series (2020 inch)



DC Bias Characteristics (Typical)

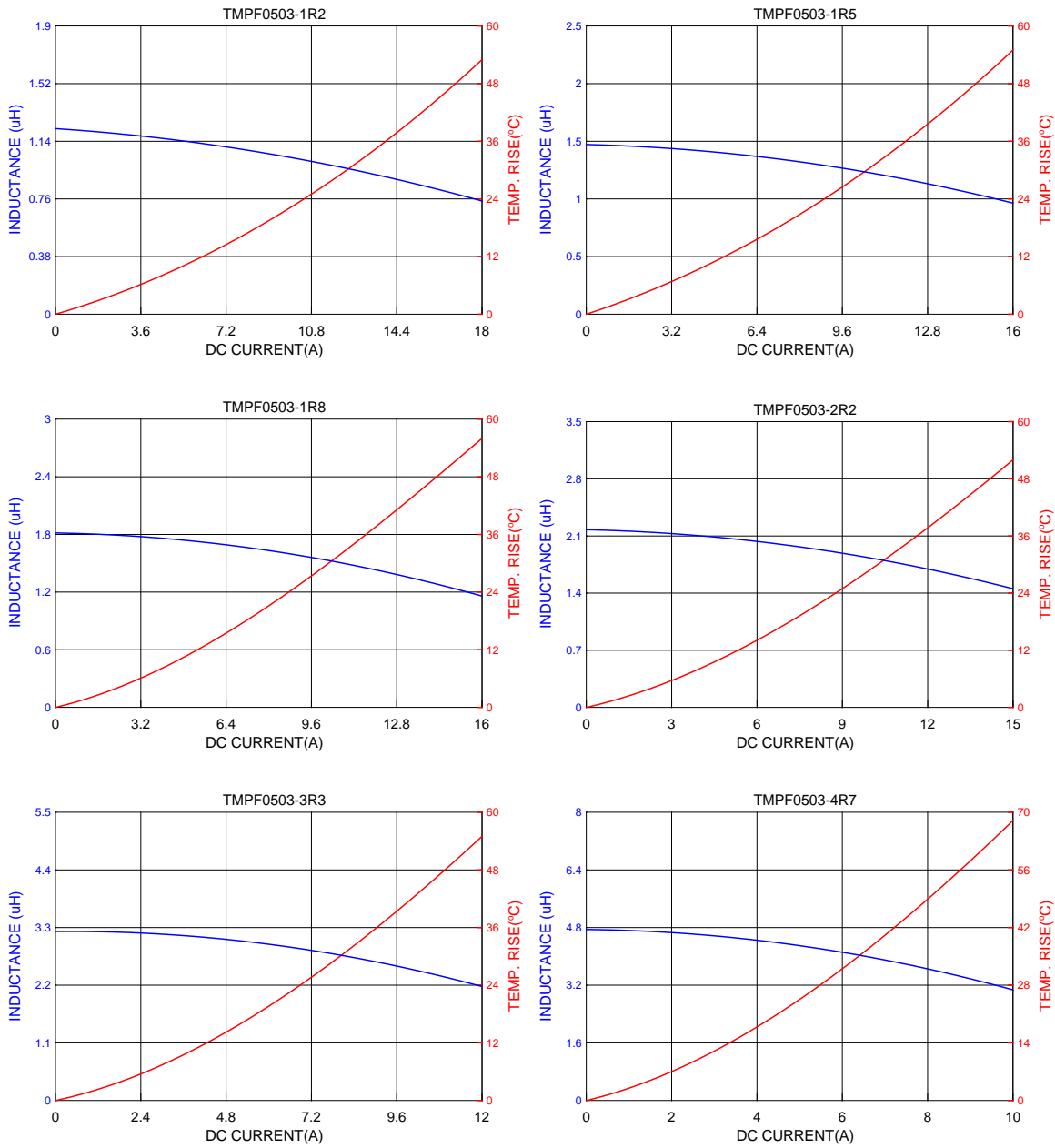

Molding Type High Current Power Inductors

TMPF0603A Series (2525 inch)

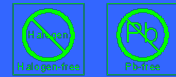

■ Dimensions

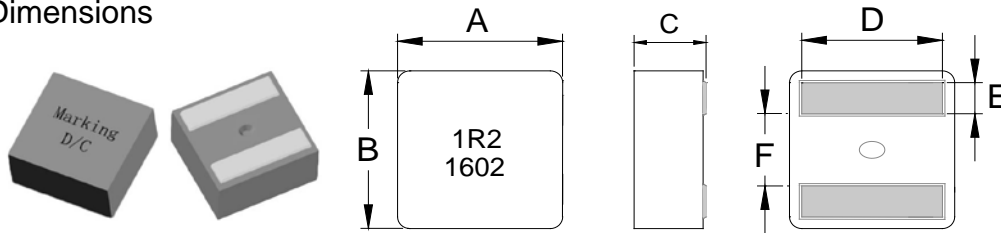

Series	Inductance Range	A (mm)	B (mm)	C (mm)	D (mm)	E (mm)	F (mm)
TMPF0603A	1.2uH and below	6.6±0.2	6.4±0.2	2.8±0.2	See Spec table	1.4±0.2	2.6±0.25
	1.5uH and above			2.9±0.2			

■ Specifications

Part Number	Inductance(uH) ±20% @ 0 A	I rms(A) Typ		I sat(A)		DCR (mΩ) Typ.	DCR (mΩ) Max.	D(mm) ±0.3
		20°C rise	40°C rise	Typ	Max			
TMPF0603A-R18MN-D	0.18	24.0	32.0	40.0	36.0	1.60	1.75	5.30
TMPF0603A-R33MN-D	0.33	20.0	25.0	32.0	28.0	2.25	2.50	5.55
TMPF0603A-R56MN-D	0.56	17.0	22.0	29.0	25.0	3.00	3.31	5.30
TMPF0603A-1R0MN-D	1.00	13.0	18.0	23.0	18.0	5.50	6.05	5.20
TMPF0603A-1R2MN-D	1.20	12.0	16.0	22.0	16.0	6.70	7.40	5.15
TMPF0603A-1R8MN-D	1.80	10.0	14.0	18.2	13.0	9.20	10.2	5.10
TMPF0603A-2R2MN-D	2.20	7.00	10.0	15.9	11.0	11.0	12.2	5.05
TMPF0603A-3R3MN-D	3.30	6.00	8.00	12.2	9.00	18.8	20.8	5.00
TMPF0603A-4R5MN-D	4.50	5.00	7.00	10.0	8.00	23.0	25.3	5.00

Note:

1. Test frequency : L : 100KHz /0.1V.
2. All test data referenced to 25°C ambient.
3. Testing Instrument : L: HP4284A,HP4395A,CH11025,CH3302,CH1320 ,CH1320S LCR METER / Rdc:CH16502, Agilent33420A MICRO OHM METER, or EQU.
4. Current that causes the specified temperature rise from 25°C ambient.
5. Saturation Current (Isat) will cause L0 to drop approximately 30%.

Molding Type High Current Power Inductors

TMPF0603A Series (2525 inch)



■ DC Bias Characteristics (Typical)

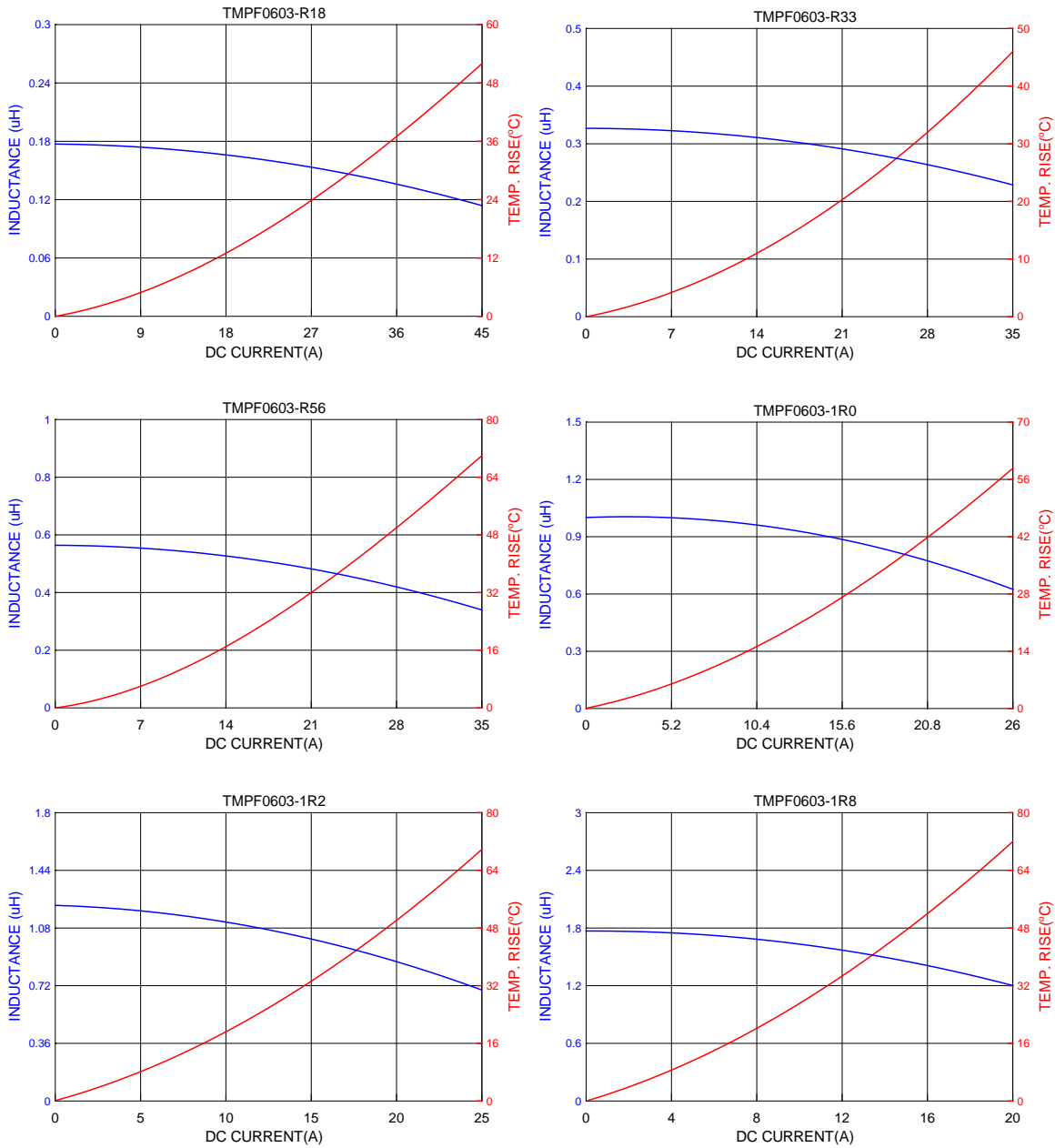



■ DC Bias Characteristics (Typical)

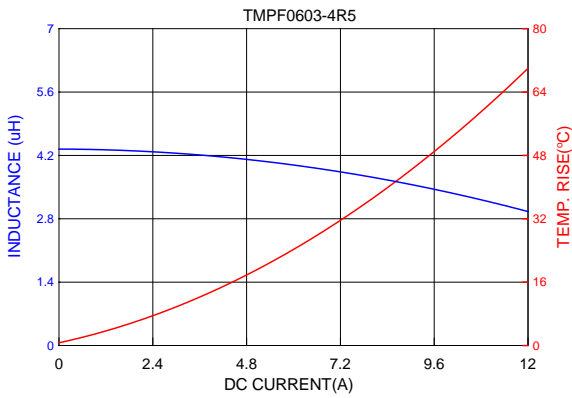
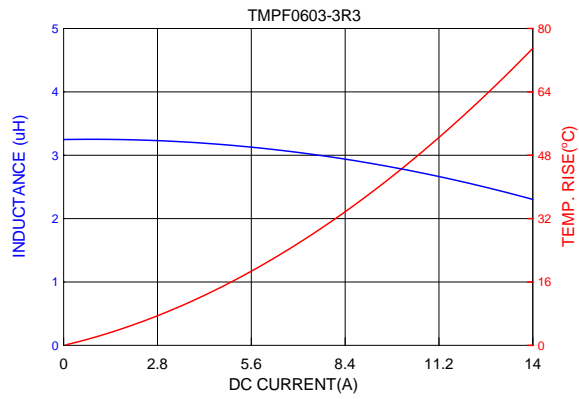
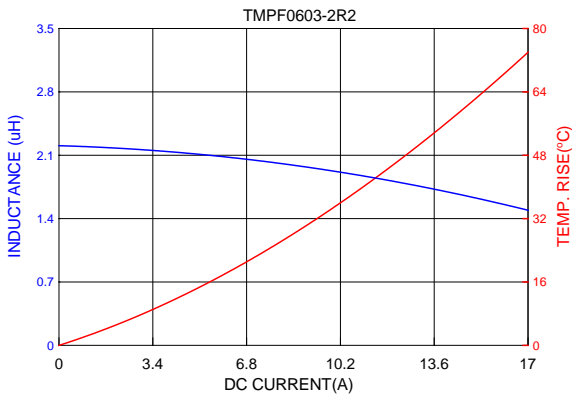

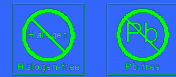

■ Dimensions

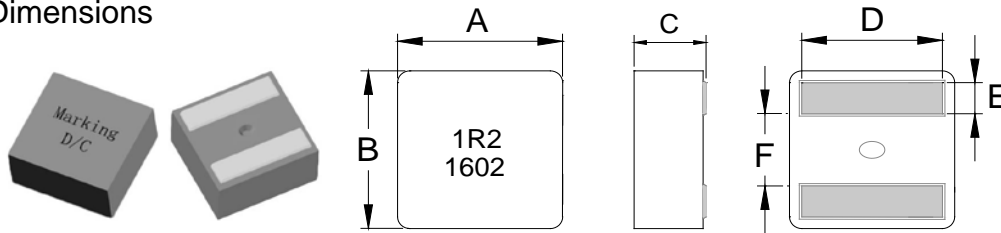

Series	A (mm)	B (mm)	C (mm)	D (mm)	E (mm)	F (mm)
TMPF0605A	6.6±0.2	6.4±0.2	4.8±0.2	See Spec table	1.4±0.2	2.6±0.25

■ Specifications

Part Number	Inductance (uH) ±20% @ 0 A	I rms(A) Typ		I sat(A)		DCR (mΩ) Typ.	DCR (mΩ) Max.	D (mm) ±0.3
		20°C rise	40°C rise	Typ	Max			
TMPF0605A-1R0MN-D	1.00	15	20	23.0	18.0	4.1	4.52	5.3
TMPF0605A-1R2MN-D	1.20	14	18	22.0	16.0	5.3	5.83	5.3
TMPF0605A-1R5MN-D	1.50	13	17	19.5	14.5	5.7	6.3	5.3
TMPF0605A-1R8MN-D	1.80	12	16	18.5	13.5	6.4	7.1	5.3
TMPF0605A-2R2MN-D	2.20	10	13	16.0	12.0	7.7	8.5	5.2
TMPF0605A-3R3MN-D	3.30	8.5	11	12.5	10.0	11.2	12.5	5.2
TMPF0605A-4R3MN-D	4.30	7.0	9.0	11.0	8.5	15.1	16.2	5.2
TMPF0605A-4R7MN-D	4.70	6.5	8.5	10.5	8.0	16.7	18.4	5.2

Note:

1. Test frequency : L : 100KHz /0.1V.
2. All test data referenced to 25°C ambient.
3. Testing Instrument : L: HP4284A,HP4395A,CH11025,CH3302,CH1320 ,CH1320S LCR METER / Rdc:CH16502, Agilent33420A MICRO OHMMETER,or EQU.
4. Current that causes the specified temperature rise from 25°C ambient.
5. Saturation Current (Isat) will cause L0 to drop approximately 30%.

Molding Type High Current Power Inductors

TMPF0605A Series (2525 inch)



■ DC Bias Characteristics (Typical)

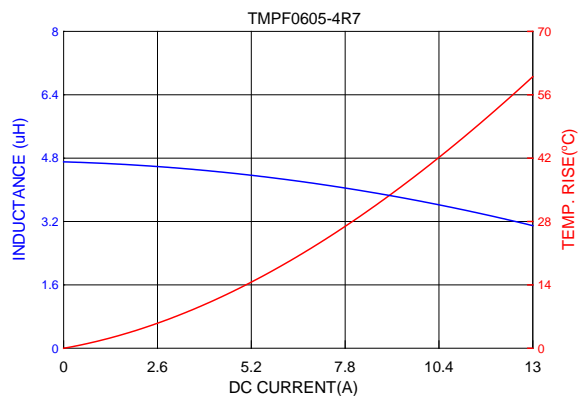
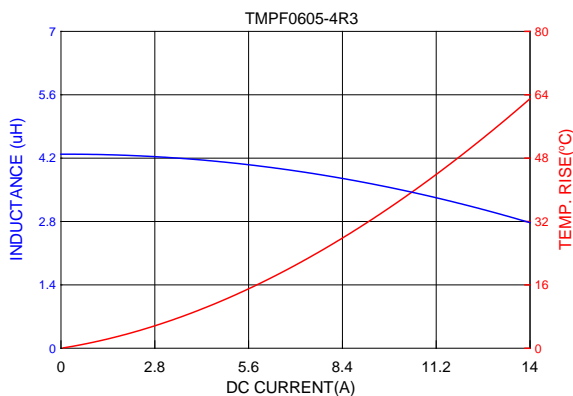
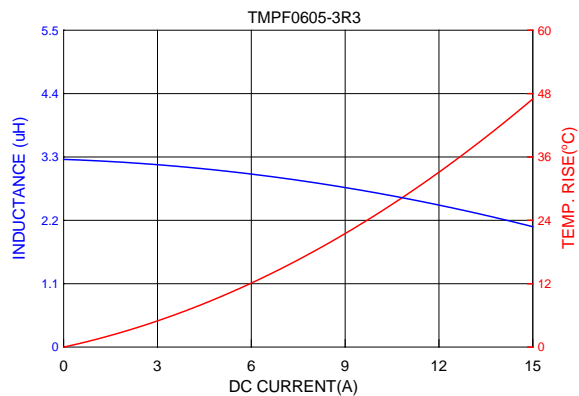
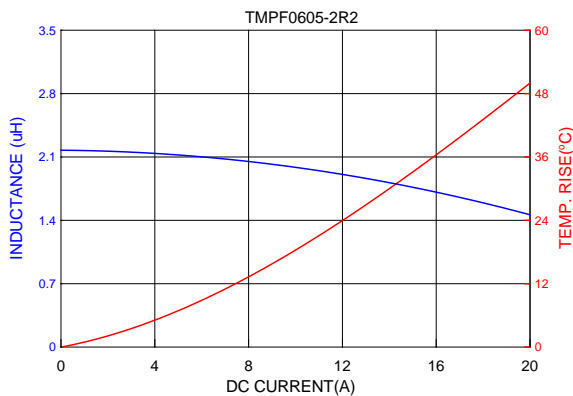
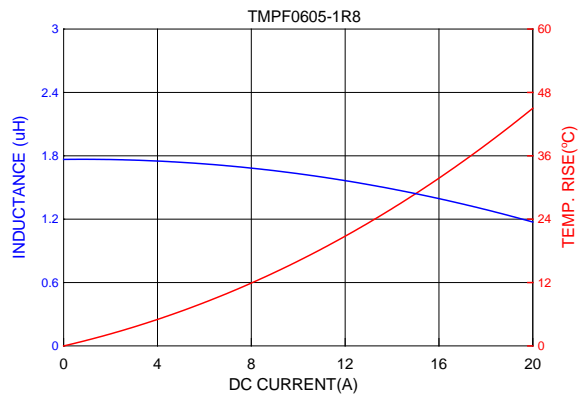
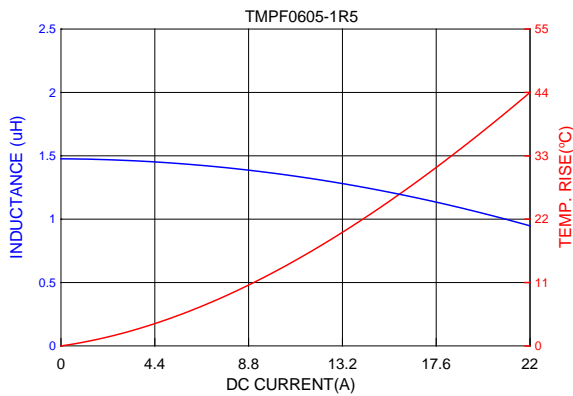
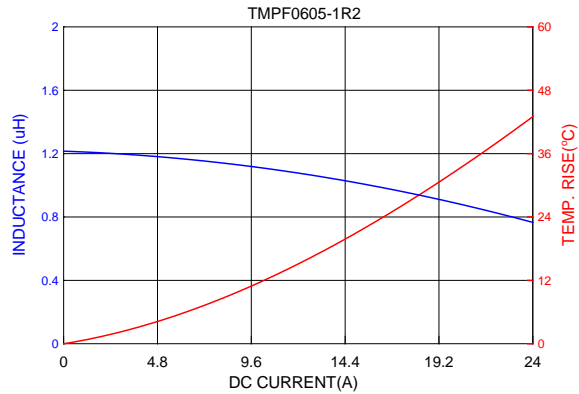
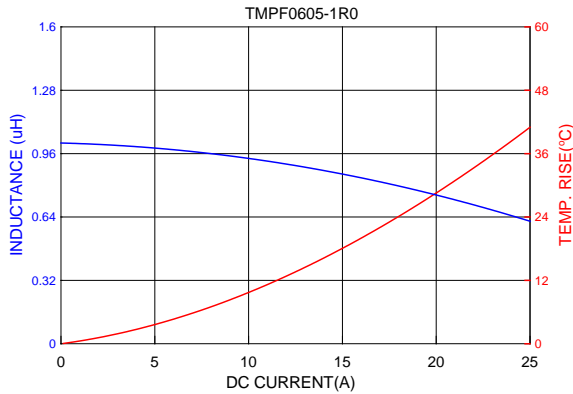

Molding Type High Current Power Inductors

TMPF0703A Series (2828 inch)

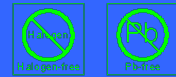

■ Dimensions

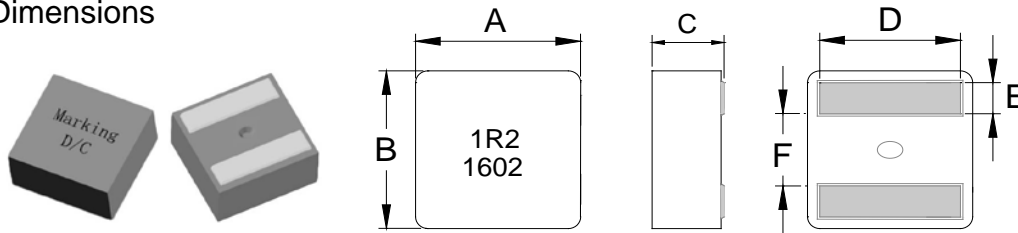

Series	A (mm)	B (mm)	C (mm)	D (mm)	E (mm)	F (mm)
TMPF0703A	7.80±0.25	7.60±0.20	2.90±0.2	See Spec Table	1.75±0.2	3.15±0.25

■ Specifications

Part Number	Inductance (uH) ±20% @ 0 A	I rms(A) Typ		I sat(A)		DCR (mΩ) Typ.	DCR (mΩ) Max.	D (mm) ±0.3
		20°C rise	40°C rise	Typ	Max			
TMPF0703A-R60MN-D	0.60	18.0	23.0	36.0	32.0	2.90	3.20	6.6
TMPF0703A-1R0MN-D	1.00	16.1	21.8	30.0	28.0	4.55	5.00	6.6
TMPF0703A-1R5MN-D	1.50	12.0	15.3	25.0	23.5	7.50	8.25	6.6
TMPF0703A-2R2MN-D	2.20	10.0	13.0	19.0	17.0	12.4	13.7	6.2
TMPF0703A-3R3MN-D	3.30	8.00	10.0	15.0	13.0	16.3	18.0	6.2
TMPF0703A-4R7MN-D	4.70	6.90	9.00	13.5	12.2	24.2	26.7	6.2
TMPF0703A-5R6MN-D	5.60	5.30	7.30	12.5	11.5	30.1	33.2	6.2
TMPF0703A-6R8MN-D	6.80	4.50	6.80	12.0	11.0	38.6	42.5	6.2
TMPF0703A-8R2MN-D	8.20	3.00	5.90	10.2	9.0	44.3	48.8	6.2

Note:

1. Test frequency : L : 100KHz /0.1V.
2. All test data referenced to 25°C ambient.
3. Testing Instrument : L: HP4284A, HP4395A, CH11025, CH3302, CH1320, CH1320S LCR METER / Rdc: CH16502, Agilent33420A MICRO OHM METER, or EQU.
4. Current that causes the specified temperature rise from 25°C ambient.
5. Saturation Current (Isat) will cause L0 to drop approximately 30%.

Molding Type High Current Power Inductors

TMPF 0703A Series (2828 inch)



■ DC Bias Characteristics (Typical)

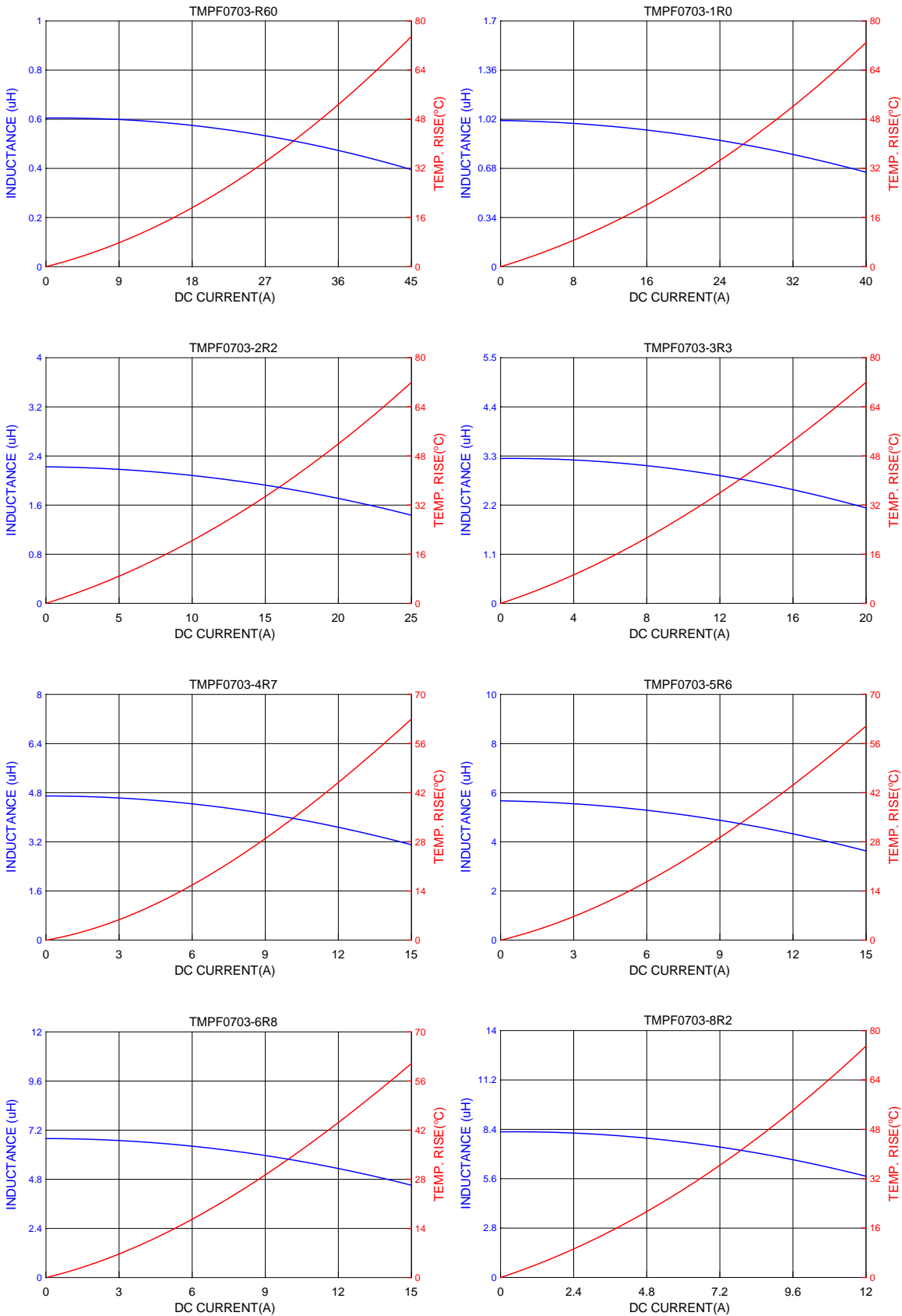

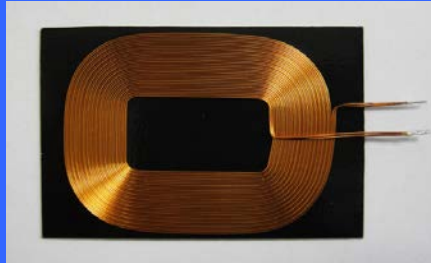

Wireless Power Charging

■ Wireless Power Charging

PTX Series	254
CTX Series	255
PRX Series	256



■ Dimensions

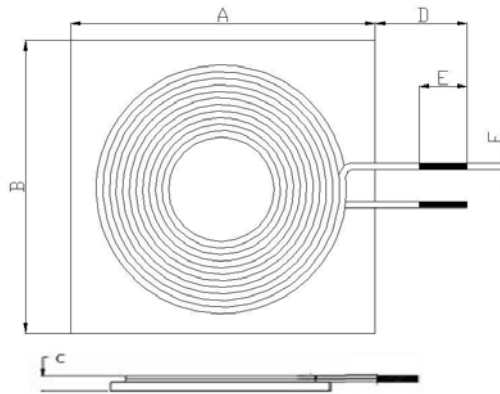
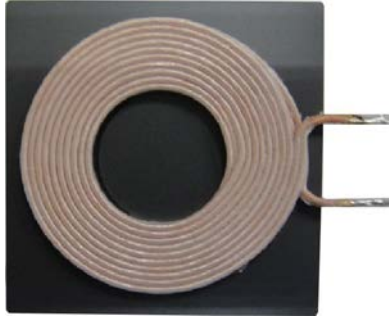

Series	A(mm)	B(mm)	C(mm)	D(mm)	E(mm)	F(mm)
PTX505035-SN	50±0.5	50±0.5	3.5 typ.	30 typ.	5.0 typ.	1.2 typ.
PTX505040-SN	50±0.5	50±0.5	4.0 typ.	30 typ.	5.0 typ.	2.4 typ.
PTX505050-SN	50±0.5	50±0.5	5.0 typ.	30 typ.	5.0 typ.	1.2 typ.
PTX505055-SN	50±0.5	50±0.5	5.5 typ.	30 typ.	5.0 typ.	2.4 typ.
PTX505055-EN	50±0.5	50±0.5	5.5 typ.	30 typ.	5.0 typ.	1.2 typ.

Units: mm

■ Specifications

Part Number	Inductance (uH)	Tolerance (%)	Test Frequency (Hz)	DCR(Ω) typ.	Q typ.	Turns
PTX505035-10W5MSN-30-00	6.6	±10%	100K/1V	0.037	90	10
PTX505040-10W5MSN-30-00	6.0	±10%	100K/1V	0.020	60	10
PTX505050-10W5MSN-30-00	6.6	±10%	100K/1V	0.037	90	10
PTX505055-10W5MSN-30-00	6.0	±10%	100K/1V	0.020	60	10
PTX505055-20W5MEN-30-00	24.0	±10%	100K/1V	0.056	110	20

NOTE: Efficiency was tested by T.I. Chip set.

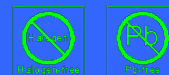

■ Dimensions

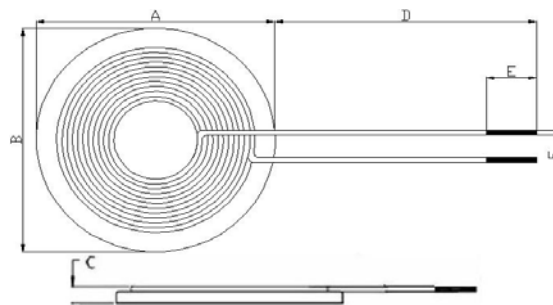

Series	A(mm)	B(mm)	C(mm)	D(mm)	E(mm)	F(mm)
CTX505028-SN	50±0.5	50±0.5	2.8 typ.	30 typ.	5.0 typ.	1.2 typ.
CTX505040-SN	50±0.5	50±0.5	4.0 typ.	30 typ.	5.0 typ.	2.4 typ.

Units: mm

■ Specifications

Part Number	Inductance (uH)	Tolerance (%)	Test Frequency (Hz)	DCR(Ω) typ.	Q typ.	Turns
CTX505028-10W5MSN-30-T0	6.3	±10%	100K/1V	0.037	90	10
CTX505040-10W5MSN-30-T0	6.0	±10%	100K/1V	0.018	80	10

NOTE: Efficiency was tested by T.I. Chip set.



■ Dimensions

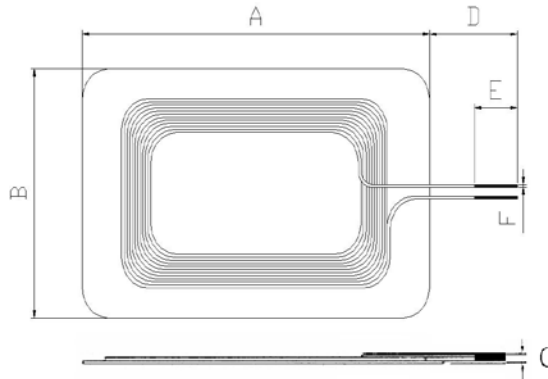

Series	A(mm)	B(mm)	C(mm)	D(mm)	E(mm)	F(mm)
PRX383109	38±0.5	31±0.5	0.9 typ.	8±1.0	3.0 typ.	0.5 typ.
PRX423809	42±0.5	38±0.5	0.9±0.3	10±1.0	5.0±0.3	0.5 typ.
PRX483209	48±0.5	32±0.5	0.9±0.3	35 typ.	10.0 typ.	0.6 typ.

Units: mm

■ Specifications

Part Number	Inductance (uH)	Tolerance (%)	Test Frequency (Hz)	DCR(Ω) typ.	Q typ.	Turns
PRX382109-14KFA-01	10.0	±10%	100K/1V	0.180	28	14
PRX423809-13KFA-01	12.5	±10%	100K/1V	0.245	30	13
PRX483209-14KFA-01	10.5	±10%	100K/1V	0.236	28	14

NOTE: Efficiency was tested by T.I. Chip set.

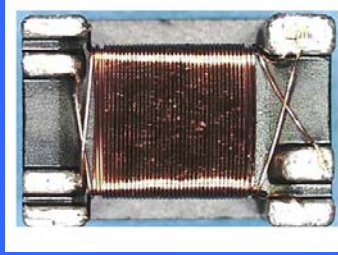

LAN Transformers & Modules

■ LAN Transformers

TXF Series 258

■ LAN Transformer Modules

LAN 12M162S Series 260

LAN 16G241 Series 261

LAN 12M162P Series 262

LAN 16G241P/242P Series 264

LAN 17G241P Series 266

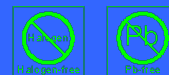

■ Dimensions

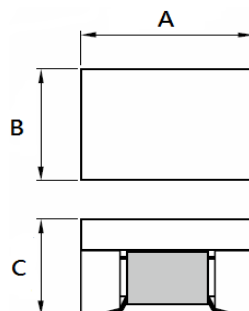
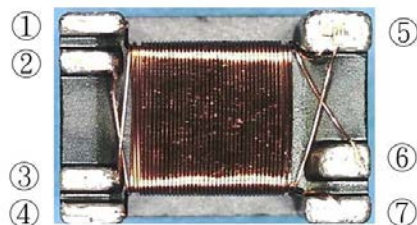

Series	A(mm)	B(mm)	C(mm)
453229NF-7P	4.70±0.2	3.22±0.2	2.9 Max
453222NF-7P	4.70±0.2	3.22±0.2	2.2Max

■ Specifications

TAI-TECH Part Number	Inductance (uH) (DC bias 0mA) ① to ② or ③-④ short ⑥ to ⑦	Inductance (uH) (DC bias 8mA) ① to ② or ③-④ short ⑥ to ⑦	Test Frequency (Hz/V)	Insertion loss	Cp Capacitance (pF) ③-④ short to ⑤	Turns ratio ① to ② : ③-④ short ⑥ to ⑦	HI-POT
TXF453229NF-351-7P	350 uH(Min)	-	100K/0.1	1-100MHZ -1.5dB Max	35pF(typ)	1:1	
TXF453229NF-381-7P	380 uH(Min)	350 uH(Min)	100K/0.1	1-100MHZ -1.5dB Max	35pF(typ)	1:1	AC 1.5KV 60SEC
TXF453222NF-351-7P	350 uH(Min)	-	100K/0.1	1-100MHZ -1.5dB Max	35pF(typ)	1:1	AC 1.5KV 60SEC

■ Schematic Diagram

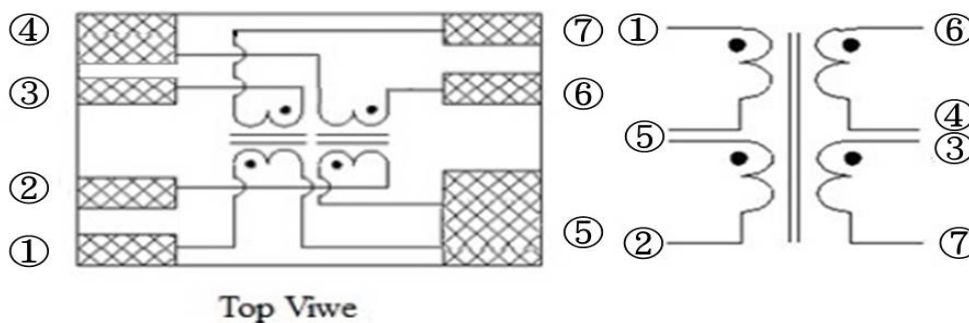



■ Dimensions

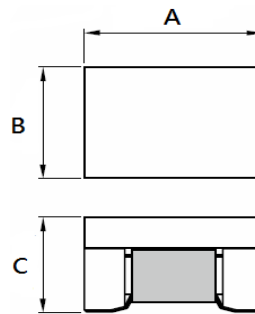
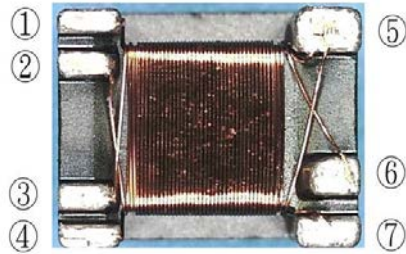

Series	A(mm)	B(mm)	C(mm)
535340NF-7P	5.36±0.2	5.36±0.2	4.0 Max

■ Specifications

TAI-TECH Part Number	Inductance (uH) (DC bias 0mA) ①to② or ③-④short ⑥to⑦	Test Frequency (Hz/V)	Cp Capacitance(pF) ③-④short to⑤	Turns ratio ①to② : ③-④short ⑥to⑦	HI-POT
TXF535340NF-381-7P	380 uH (min.)	100K/0.1	61pF (typ)	1:1	AC 1.5KV 60SEC

■ Schematic Diagram

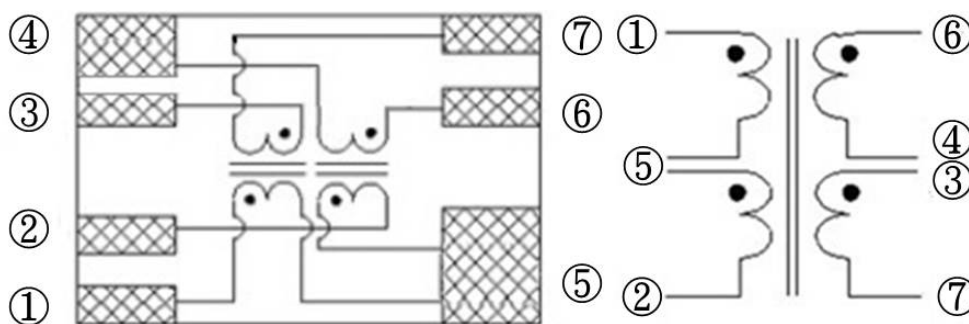

Top View

Molding Type High Current Power Inductors

LAN 12M162 S Series

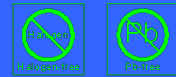

■ Dimensions

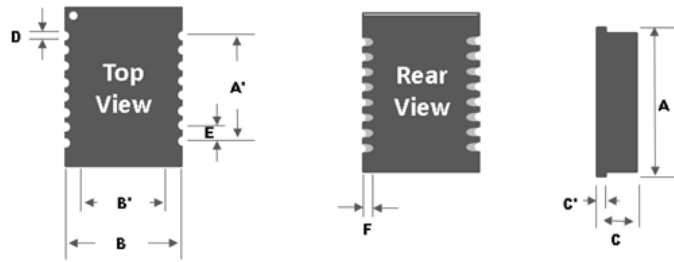

Series	A(mm)	A'(mm)	B(mm)	B'(mm)	C(mm)	C'(mm)	D(mm)	E(mm)	F(mm)
LAN-12M162S7A0	12.7±0.1	8.87±0.1	9.0±0.1	7.2±0.1	4.0±0.1	0.8±0.1	0.4±0.1	1.27±0.1	0.3±0.1
LAN-12M162S7A8	12.7±0.1	8.87±0.1	9.0±0.1	7.2±0.1	4.0±0.1	0.8±0.1	0.6±0.1	1.27±0.1	0.3±0.1

■ Specifications

Part Number	Insertion Loss (dB Max)	Return Loss (dB Min)			DCMR (dB Min)		
		1~100MHz	30MHz	60MHz	100MHz	30MHz	60MHz
LAN-12M162S7A0	-1	-20	-15	-10	-25	-25	-25
LAN-12M162S7A8	-1	-20	-15	-10	-25	-25	-25

■ Schematic and Pin Define

LAN-12M162S7A0

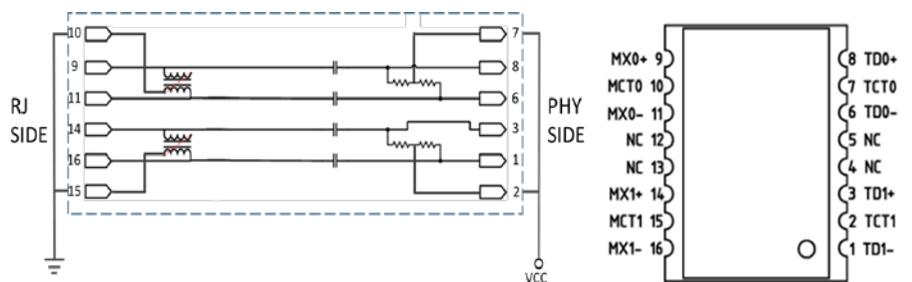

LAN-12M162S7A8

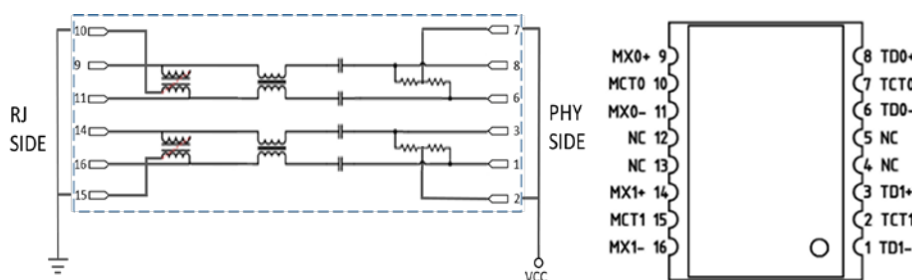

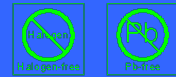

■ Dimensions

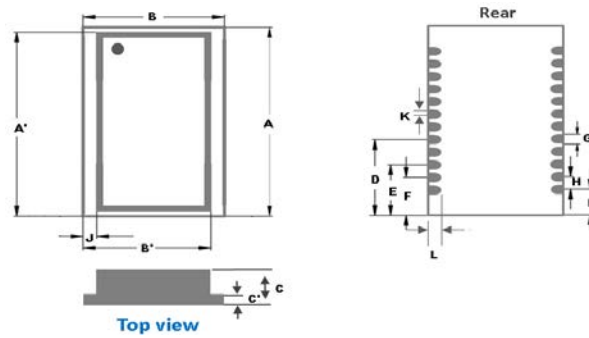

Series	units: mm	A	A'	B	B'	C	C'	D	E	F	G	H	I	J	K	L
LAN-16G241F1A8		16.5	15.99	10.0	9.5	2.3	0.6	6.75	4.75	3.75	0.4	1.0	2.75	0.65	0.2	1.0
LAN-16G241S1A8		16.5	15.99	10.0	9.5	4.15	0.8	6.75	4.75	3.75	0.4	1.0	2.75	0.65	0.2	0.3
LAN-16G241S1B8		16.5	15.99	10.0	9.5	4.15	0.8	6.75	4.75	3.75	0.6	1.0	2.75	0.65	0.2	1.0

■ Specifications

Part Number	Insertion Loss (dB Max)	Return Loss (dB Min)			DCMR (dB Min)		
		1~100MHz	30MHz	60MHz	100MHz	30MHz	60MHz
LAN-16G241F1A8	-1	-20	-15	-10	-25	-25	-25
LAN-16G241S1A8	-1	-20	-15	-10	-25	-25	-25
LAN-16G241S1B8	-1	-20	-15	-10	-25	-25	-25

■ Schematic and Pin Define

LAN-16G241F1A8

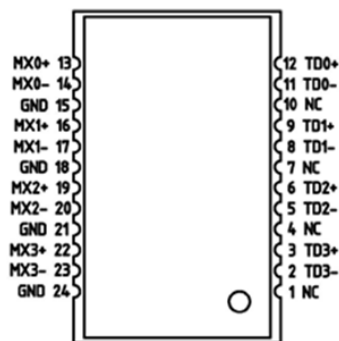
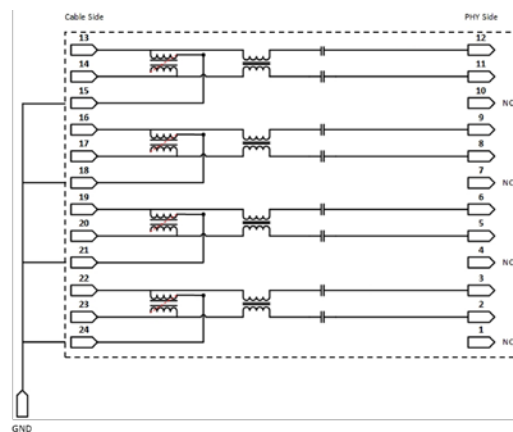

Lan Modules for 1G Ethernet, Capacitor Type

LAN 16G241 F/S Series



LAN-16G241S1A8

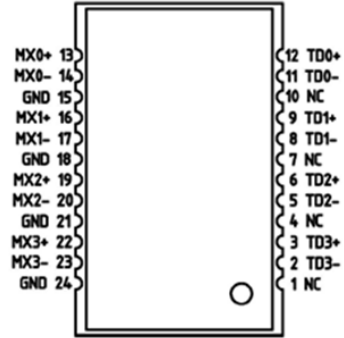
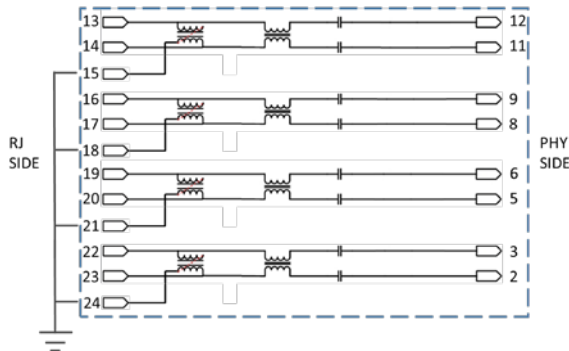

LAN-16G241S1B8

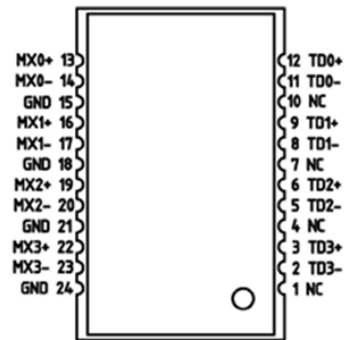
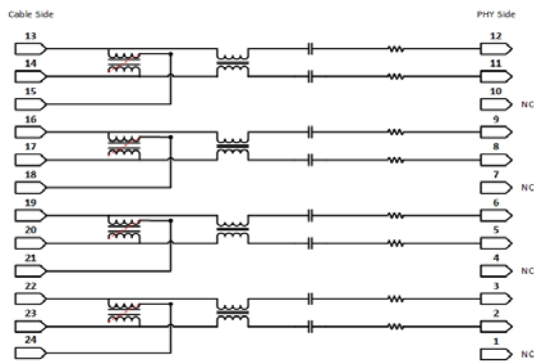

LAN 12M162 P Series



■ Dimensions

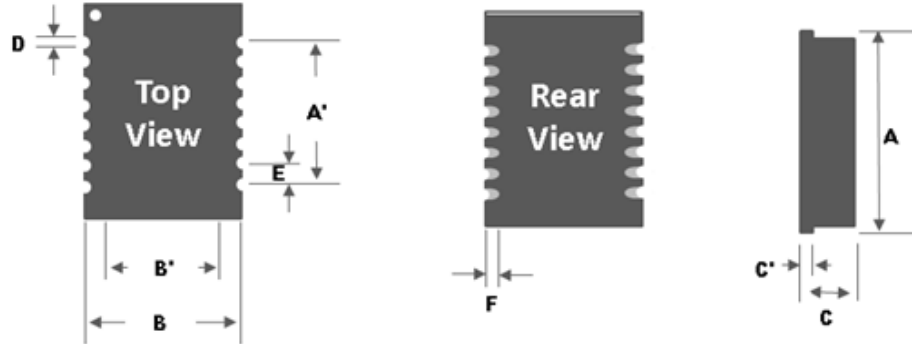

Series	A(mm)	A'(mm)	B(mm)	B'(mm)	C(mm)	C'(mm)	D(mm)	E(mm)	F(mm)
LAN-12M162P7A8	12.7±0.25	8.89±0.25	8.67±0.25	7.2±0.25	4.0±0.25	0.8±0.05	0.6±0.1	1.27±0.25	1.00±0.25
LAN-12M162P7B0	12.7±0.25	8.89±0.25	8.67±0.25	7.2±0.25	4.0±0.25	0.8±0.05	0.6±0.1	1.27±0.25	1.00±0.25
LAN-12M162P7D8	12.7±0.25	8.89±0.25	8.67±0.25	7.2±0.25	4.0±0.25	0.8±0.05	0.6±0.1	1.27±0.25	1.00±0.25
LAN-12M165P7A8	12.7±0.25	8.89±0.25	8.67±0.25	7.2±0.25	4.0±0.25	0.8±0.05	0.6±0.1	1.27±0.25	1.00±0.25

■ Specifications

Part Number	Insertion Loss (dB Max)	Return Loss (dB Min)				Cross talk (dB Min)	DCMR (dB Min)	
	1~100 MHz	1~30 MHz	40 MHz	50 MHz	60~80 MHz	1~100 MHz	1~60 MHz	60~100 MHz
LAN-12M162P7A8	-1.2	-18	-15.5	-13.5	-10	-38	-33	-26
LAN-12M162P7B0	-1.2	-18	-15.5	-13.5	-10	-38	-33	-26
LAN-12M162P7D8	-1.2	-18	-15.5	-13.5	-10	-38	-33	-26
LAN-12M165P7A8	-1.2	-18	-15.5	-13.5	-10	-38	-33	-26

Note:

1. All test data referenced to 25°C ambient
2. Hi-Pot resistance of 1500 VAC for 1 minute

LAN 12M162 P Series



■ Schematic and Pin Define

LAN-12M162P7A8

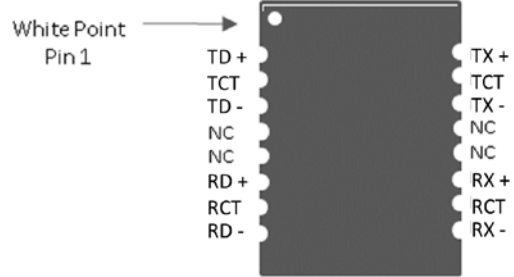
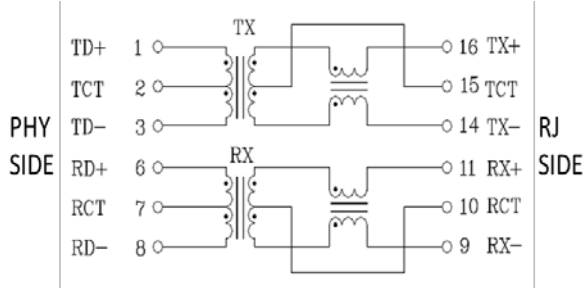

LAN-12M162P7B0

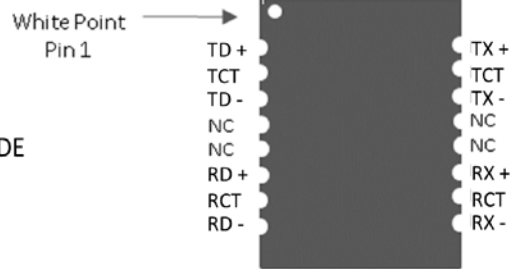
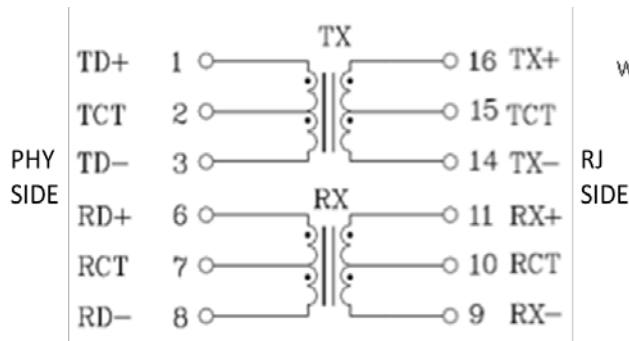

LAN-12M162P7D8

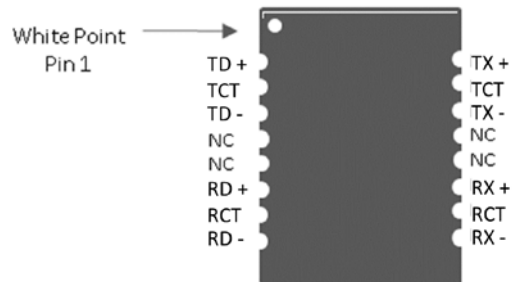
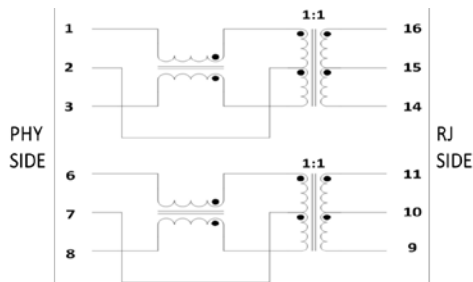

LAN-12M165P7A8

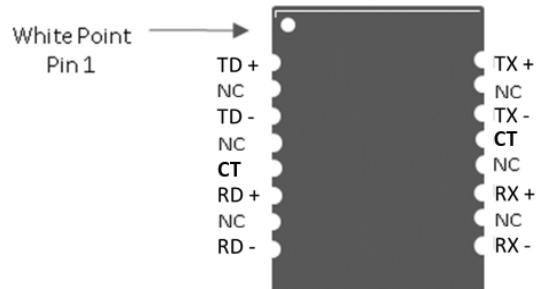
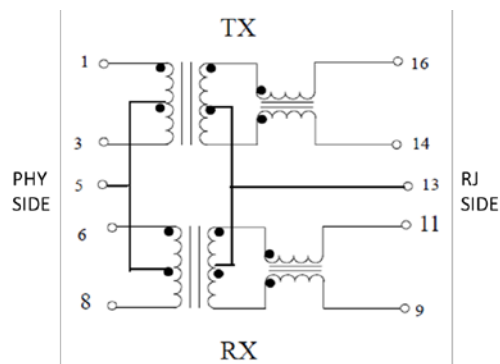

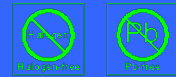

■ Dimensions

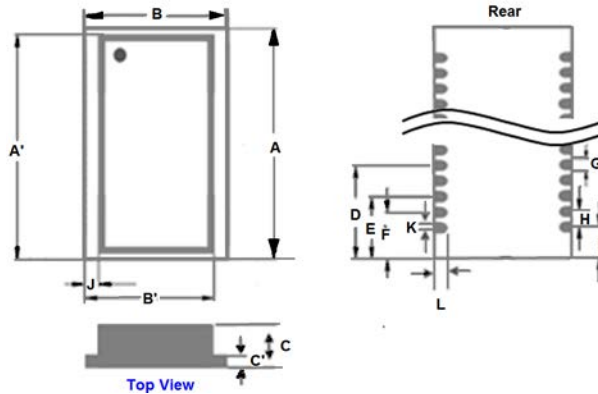

Series	units: mm	A	A'	B	B'	C	C'	D	E	F	G	H	I	J	K	L
LAN-16G241P1A8		16.5	16.0	10.3	9.65	4.1	0.8	6.75	4.75	3.75	0.4	1.0	2.75	0.65	0.2	1.0
LAN-16G241P1B8		16.5	16.0	10.3	9.65	4.1	0.8	6.75	4.75	3.75	0.4	1.0	2.75	0.65	0.2	1.0
LAN-16G242P1A8		16.5	16.0	10.3	9.65	4.1	0.8	6.75	4.75	3.75	0.4	1.0	2.75	0.65	0.2	1.0

■ Specifications

Part Number	Insertion Loss (dB Max)	Return Loss (dB Min)					Cross talk (db Min)	DCMR (dB Min)	
		1~100 Mhz	1~30 Mhz	40 Mhz	50 Mhz	60~80 Mhz		100 Mhz	1~100 Mhz
LAN-16G241P1A8	-1.1	-18	-14.4	-13.1	-12	-10	-35	-35	-30
LAN-16G241P1B8	-1.1	-18	-14.4	-13.1	-12	-10	-35	-35	-30
LAN-16G242P1A8	-1.1	-18	-14.4	-13.1	-12	-10	-35	-35	-30

Note:

1. All test data referenced to 25°C ambient
2. Hi-Pot resistance of 1500 VAC for 1 minute

Lan Modules for 1G Ethernet, Inductor Type

LAN 16G241/242 P Series

■ Schematic and Pin Define

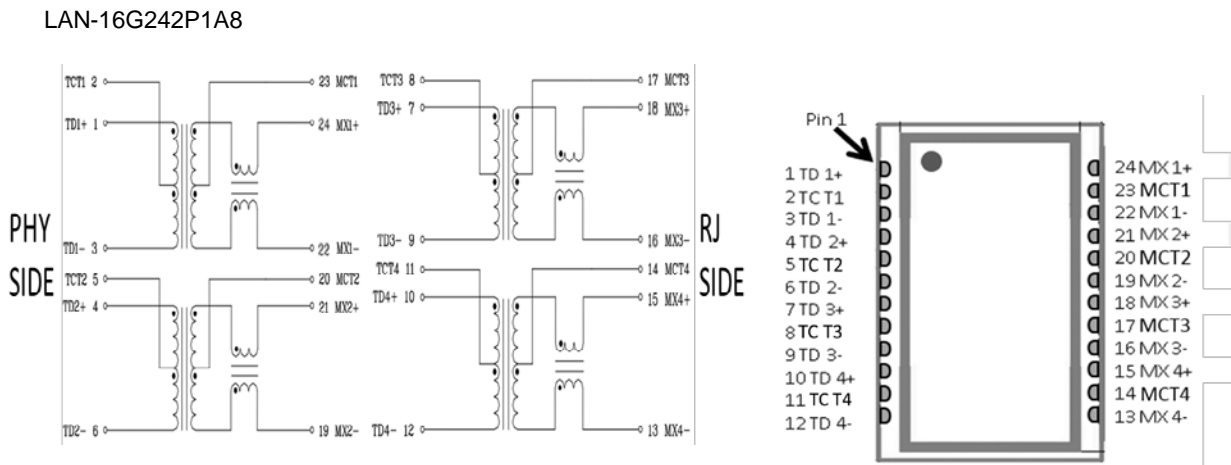
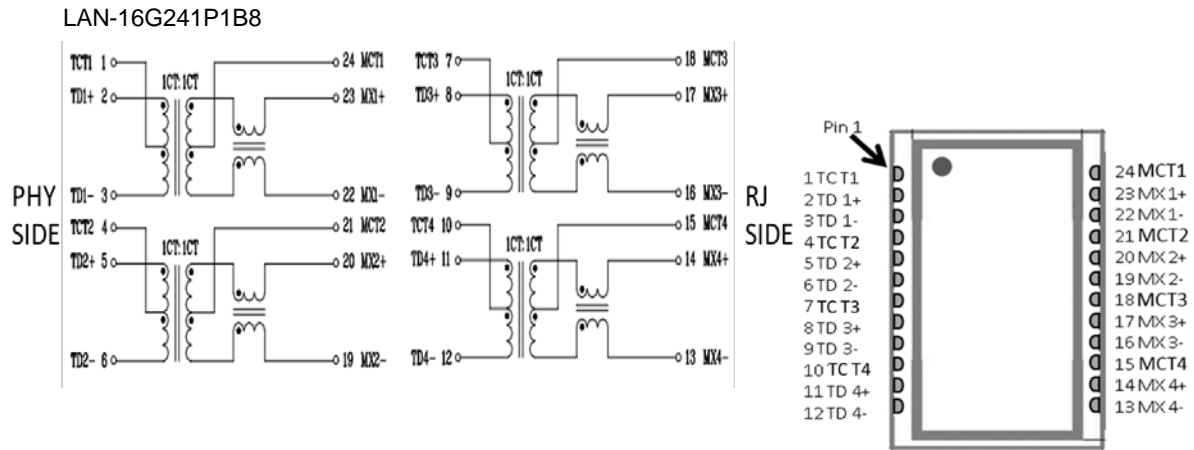
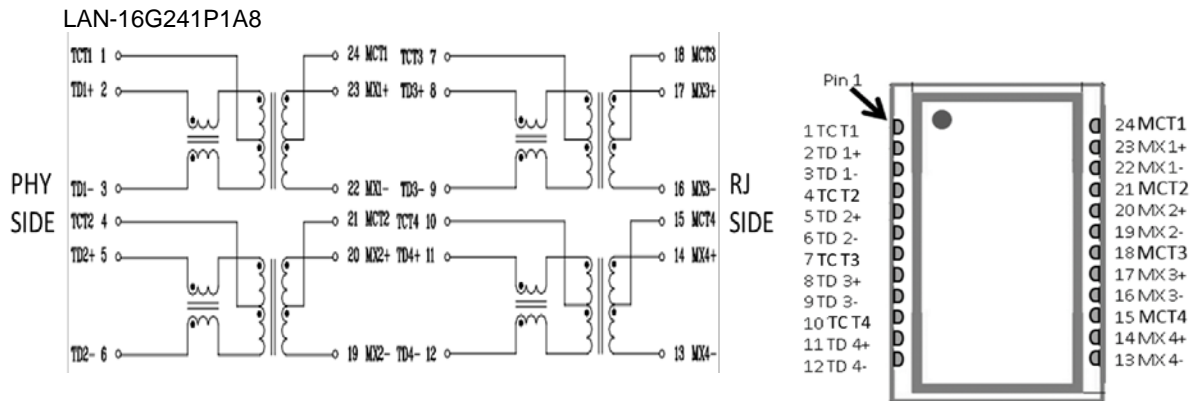

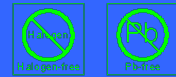

■ Dimensions

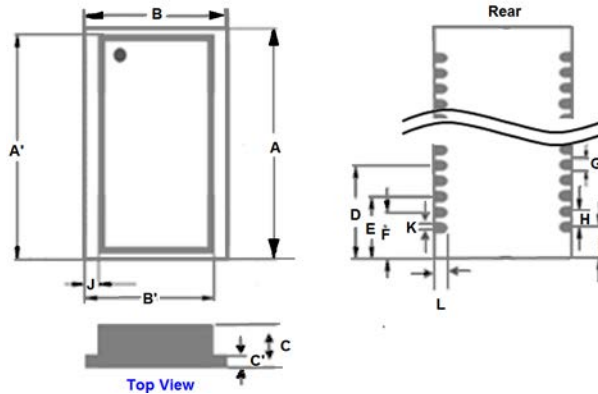

Series	units: mm	A	A'	B	B'	C	C'	D	E	F	G	H	I	J	K	L
LAN-17G241P7B8		17.53	17.03	14.6	13.9	4.5	1.0	6.86	4.32	3.05	0.8	1.27	1.78	0.67	0.3	1.1

■ Specifications

Part Number	Insertion Loss (dB Max)	Return Loss (dB Min)					Cross talk (db Min)	DCMR (dB Min)	
	1~100 MHz	1~30 MHz	40 MHz	50 MHz	60~80 MHz	100 MHz	1~100 MHz	1~60 MHz	60~100 MHz
LAN-17G241P7B8	-1.1	-18	-14.4	-13.1	-12	-10	-35	-35	-30

Note:

1. All test data referenced to 25°C ambient
2. Hi-Pot resistance of 1500 VAC for 1 minute

■ Schematic and Pin Define

LAN-17G241P7B8

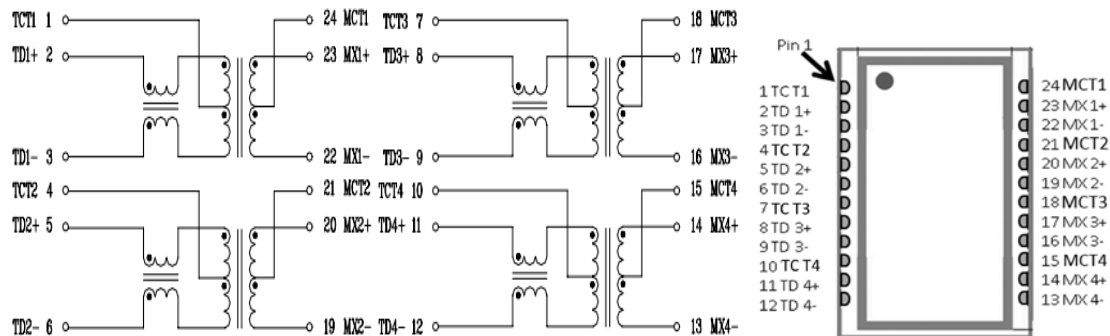



PC Board Gasket

■ PC Board Gasket

YPC Series 269



■ Dimensions

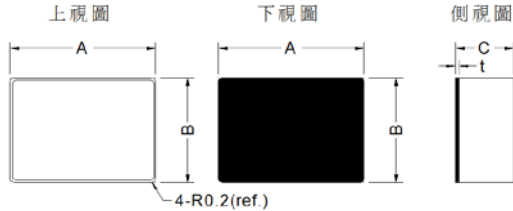

A	2.00±0.05
B	1.50±0.05
C	0.90+0.07/-0.03
t	0.05±0.02

Units: mm

■ Specifications

Tai-Tech Part Number	Soldering strength typ. (Kgf)	Anti-breaking force typ. (Kgf)	Surface Resistance Typ.(Ω.cm)
YPC201509T1-00T	3.0	15.0	1.0x10 ¹³

In compliance with EIA 595

Soldering and Mounting

■ Soldering

Mildly activated rosin fluxes are preferred. TAI-TECH terminations are suitable for all wave and re-flow soldering systems. If hand soldering cannot be avoided, the preferred technique is the utilization of hot air soldering tools.

1. Solder Re-flow:

Recommended temperature profiles for re-flow soldering in Figure 1.

2. Soldering Iron (Figure 2):

Products attachment with a soldering iron is discouraged due to the inherent process control limitations. In the event that a soldering iron must be employed, the following precautions are recommended.

- Preheat circuit and products to 150°C
- Never contact the ceramic with the iron tip
- Use a 20 watt soldering iron with tip diameter of 1.0mm
- 355°C tip temperature (max)
- 1.0mm tip diameter (max)
- Limit soldering time to 4~5 sec.

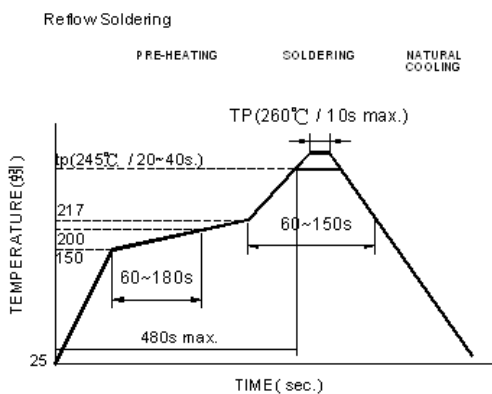

Reflow times: 3 times max.

Fig.1

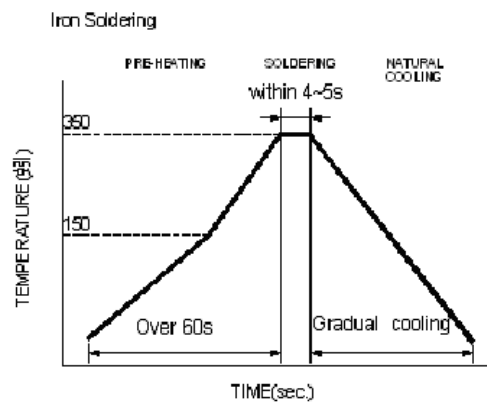

Iron Soldering times: 1 times max.

Fig.2

3. PC Board Warping:

PC Board is recommended and the on-board products are not subjected to the mechanical stress caused by warping the PC Board. The improper layout or direction might damage the on-board products. (As Figure 3. shows, products should be located in the sideways direction (Length:L > W) to avoid the mechanical stress.)

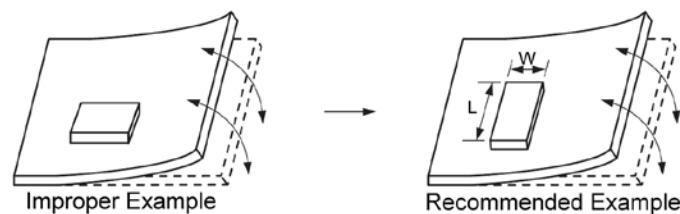
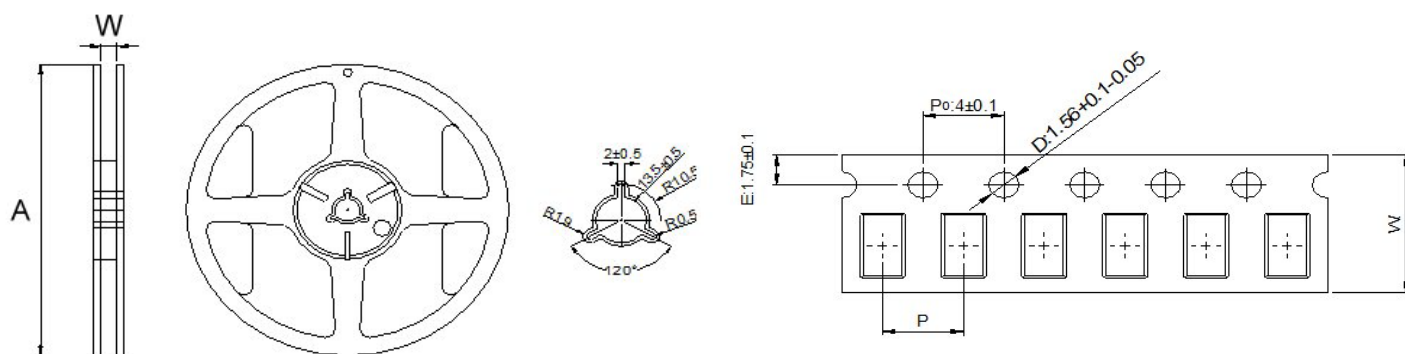

Fig. 3

■ Mounting

Please contact TAI-TECH sales representative to require the specific products "Specification for Approval" to obtain the details of Land pattern dimensions.

Packaging



Products Packaging Information

Series	A	W	P	Qty	Series	A	W	P	Qty
FCM 0402	7"	8	2	20,000	FCI 1005	7:	8	2	10,000
FCM/HCB 0603	7"	8	2	15,000	FCI 1608	7"	8	4	4,000
FCM/HCB 1005	7"	8	2	10,000	FCI 201209	7"	8	4	4,000
FCM/HCB 1608	7"	8	4	4,000	FCI 201212	7"	8	4	2,000
FCM/HCB 2012	7"	8	4	4,000	FCI 3216	7"	8	4	3,000
FCM/HCB 3216	7"	8	4	3,000	SWF 1608	7"	8	4	3,000
HCB 4516	7"	8	4	2,000	SWF 2012	7"	8	4	2,000
HCB 4532	7"	8	8	1,000	SWF 2520	7"	8	4	2,000
GHB 1005	7"	8	2	10,000	SWF 3225	7"	8	4	2,000
FCA 3216	7"	8	4	3,000	WIH 3225	7"	8	4	2,000
BPH323023	7"	8	4	1,000	HCI 0603	7"	8	2	15,000
BPH403225	7"	12	4	500	HCI 1005	7:	8	2	10,000
BPH853025	7"	16	4	500	SWI 0402	7"	8	2	4,000
MCF 0605	7"	8	2	15,000	SWI 0603	7"	8	4	3,000
MCF 0806	7"	8	2	10,000	SWI 0805	7"	8	4	2,000
MCF 1210	7"	8	4	5,000	SWI 1008	7"	8	4	2,000
HSF 1210	7"	8	4	3,000	PAS2016	7"	8	4	2,000
WCM/HDMI 2012	7"	8	4	2,000	PAS 3010/3012	7"	8	4	2,000
HSF/BCM 2012	7"	8	4	2,000	PAS 3015	7"	8	4	2,000
WCM/DCM 3216	7"	8	4	2,000	PAS 4018	13"	12	8	3,500
TCM 2520	7"	8	4	2,000	PAS 4420	7"	12	8	1,000
WCM/TCM 3225	7"	8	4	2,000	PAS 6420	7"	16	8	1,000
ACM 3225	7"	8	4	2,000	PAS 1225	13"	24	8	1,000
DCM3532	13"	12	8	2,000	Note: For more details of packaging information, please contact TAI-TECH to acquire the Specification for Approval.				
WCM/ACM4532	7"	12	8	500					
LCM 4532	7"	12	8	500					

Packaging

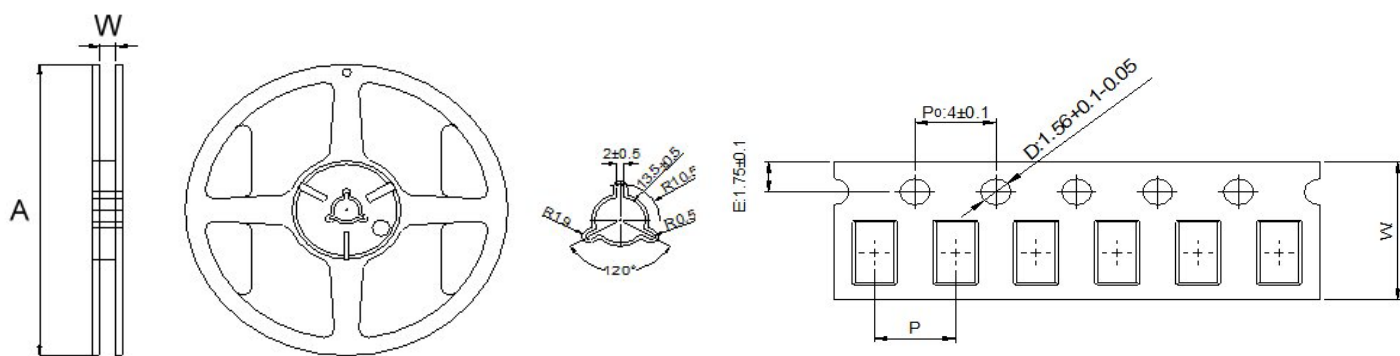

Products Packaging Information									
Series	A	W	P	Qty	Series	A	W	P	Qty
CPI 160808	7"	8	4	4,000	FPI 0302	13"	12	8	3,000
CPI 201210	7"	8	4	4,000	FPI 0403	13"	12	8	2,000
CPI 201610	7"	8	4	3,000	FPI 0503	13"	12	8	2,000
CPI 252010	7"	8	4	3,000	FPI 0504	13"	12	8	1,500
HPC 252008	7"	8	4	2,000	FPI 0703	13"	16	12	1,000
HPC 3010/12/15	7"	8	4	2,000	FPI 0705	13"	16	12	1,000
HPC 4010	13"	12	8	5,000	FWP 3216	7"	8	4	2,000
HPC 4012	13"	12	8	4,500	SDSL 10D30/40	13"	24	16	1,000
HPC 4018	13"	12	8	3,500	SDSL 10D50	13"	24	16	750
HPC 5020	7"	12	8	800	TPRHC 1204	13"	24	16	600
HPC 5040	13"	12	8	1,500	TPRHC 1205	13"	24	16	600
HPC 6020	13"	16	12	2,000	TPRHC 1207	13"	24	16	400
HPC 6045	13"	12	8	1,000	SLPI 070705	13"	16	12	1,000
HPC 8040	13"	16	12	1,000	SLPI 100705	13"	24	12	1,000
UHP/DFP 201610	7"	8	4	2,000	SLPI 131308	13"	24	16	400
DFP 201612	7"	8	4	2,000	SLPI 361108	13"	56	16	400
UHP/DFP 252010	7"	8	4	2,000	SLPI 451108	13"	56	16	300
UHP/DFP 252012	7"	8	4	2,000					
AHP 201610	7"	8	4	2,000					
AHP 252008	7"	8	4	2,000					
AHP 252010	7"	8	4	2,000					
AHP 252012	7"	8	4	2,000					
					Note: For more details of packaging information, please contact TAI-TECH to acquire the Specification for Approval.				

Packaging

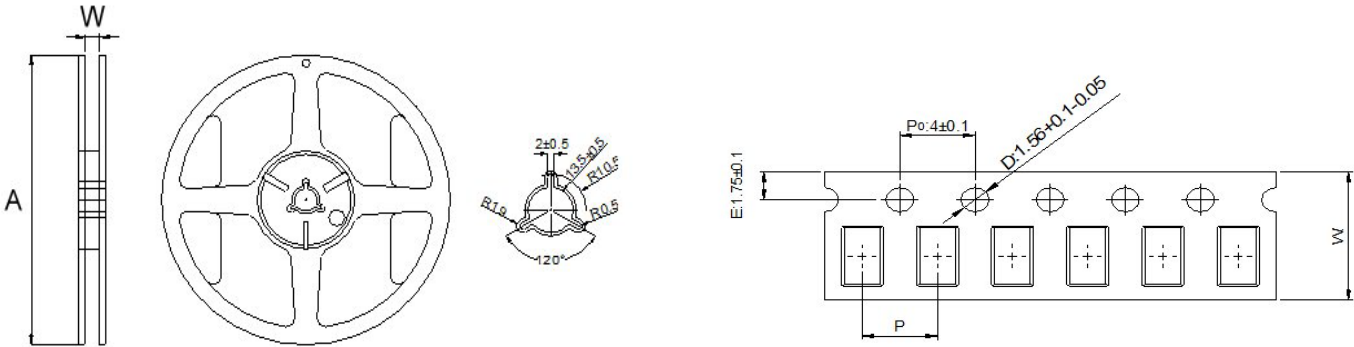

Products Packaging Information

Series	A	W	P	Qty	Series	A	W	P	Qty
TMPC 0312H	13"	12	8	4,000	TMPA 0503	13"	12	8	2,000
TMPC 0302H	13"	12	8	3,000	TMPA 0603	13"	16	12	1,000
TMPC 0412HP	13"	12	8	4,000	TMPA 1004	13"	24	16	500
TMPC 0402HP	13"	12	8	3,000	TMPA 2313	13"	44	32	120
TMPC 0512HP	13"	12	8	4,000	TMPF 0402LR	13"	12	8	3,000
TMPC 0515HP	13"	12	8	3,500	TMPF 0402	13"	12	8	3,000
TMPC 0518HP	13"	12	8	3,000	TMPF 0502	13"	12	8	3,000
TMPC 0612H	13"	16	12	3,000	TMPF 0503	13"	16	8	2,000
TMPC 0615H	13"	16	12	2,000	TMPF 0603	13"	16	12	1,000
TMPC 0618H	13"	16	12	2,000	TMPF 0605	13"	16	12	800
TMPC 0602/24H	13"	16	12	1,500	TMPF 0703	13"	16	12	1500
TMPC 0603/04H	13"	16	12	1,000	TXF 453222/29	7"	12	8	500
TMPC 0605H	13"	16	12	800	LAN 12	13"	24	16	800
TMPC 1004/05H	13"	24	16	500	LAN 16	13"	32	16	800
TMPC 1235/05	13"	24	16	500	LAN 17	13"	24	24	400
TMPC 1206/65	13"	24	16	500	YPC	13"	8	4	1,000
TMPC 1707HP	13"	32	24	300					

Note:
 For more details of packaging information, please contact TAI-TECH to acquire the Specification for Approval.